

1986 Porsche 911 Sunroof Coupe

WPOAB0916GS120538

152+ Pages

LEFT COAST CLASSICS

DE JUNG MOTORSPORT

59 PORTAL ST SUITE A

MOTATI, CA 94931

07-664-8002

AR #ARD 101025

PA# CAL000064429

R/O # : 17835

Name :

Date : 06/07/2019

License # : 1PCY741

Make : PORSCHE

Model : CARRERA

Year : 86

Odometer : 275655

Save Parts : NO

VIN : WPOAB0916GS120538

N

CA

ome:

ork:

ther:

LABOR**AMOUNT**

Change engine oil and filter.	140.00
Check transaxle oil level.	
Inspect brakes.	
Check tire pressures.	
Check lights.	
Check brake fluid level.	
Flush brake hydraulic system.	112.00
Check & R the high/low-turn signal switch.	140.00
Mirror control is not working correctly. See below*	.00

ARTS All parts new unless stated used or remanufactured		PRICE	QTY	AMOUNT
DC 54	OIL FILTER	15.82	1	15.82
5	**CASTROL OIL(PTS.)	3.50	22	77.00
602227	COPPER WASHER	.90	2	1.80
1	TECHRON	9.00	1	9.00
AB	BRAKE FLUID P/LITER	22.87	1	22.87
11 613 305 01	SWITCH-HIGH/LOW/TURN SIGNAL	246.73	1	246.73

DE JUNG MOTORSPORT

59 PORTAL ST SUITE A

MOTATI, CA 94931

07-664-8002

AR #ARD 101025

PA# CAL000064429

R/O # : 17835

Name :

Date : 06/07/2019

License # : 1PCY741

Make : PORSCHE

Model : CARRERA

Year : 86

Odometer : 275655

Save Parts : NO

VIN : WPOAB0916GS120538

CA

Work:

ther:

RECOMMENDATIONS AND TECHNICIANS NOTES

REAR VIEW MIRRORS/WIRING IN DRIVERS DOOR JAM ?

Original Estimate : 807.94

Date	Increases to Estimate					Increase
	Time	OK'd By	Phone	Emp.		

LABOR	392.00
PARTS	373.22
SUBLETS	.00
CALIF BATTERY TAX	.00
HAZARDOUS MATERIALS	8.20
SUB TOTAL	773.42
TAX	34.52
TOTAL	807.94

Parts & labor conditionally guaranteed 4,000 mi./ 90 days.

By authorizing DEJUNG MOTORSPORT to perform the repair work listed above along with necessary materials. You and your employees may operate the above vehicle for purposes of testing, inspection, or delivery at my risk. An express mechanics lien is acknowledged on above vehicle to secure the amount of repairs. Thereto it is understood that this company assumes no responsibility for loss or damage by theft or fire to vehicles placed with them for storage, sale, repair, or while road testing.

Authorized by :

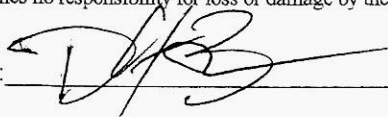

Date :

6/7/19

DE JUNG MOTORSPORT

59 PORTAL ST SUITE A

OTATI, CA 94931

07-664-8002

AR #ARD 101025

PA# CAL000064429

R/O # : 17732

Name : _____

Date : 03/12/2019

License # : 1PCY741

Make : PORSCHE

Model : CARRERA

Year : 86

Odometer : 274015

Save Parts : NO

VIN : WPOAB0916GS120538

~~JAMON BROWN~~

CA

Home: 829-5422

Work: 544-0784

Other:

ARTS All parts new unless stated used or remanufactured
011 731 035 08 GLASS-OUTER MIRROR

PRICE	QTY	AMOUNT
126.08	1	126.08

RECOMMENDATIONS AND TECHNICIANS NOTES
REAR VIEW MIRRORS/WIRING IN DRIVERS DOOR JAM ?

Original Estimate : 137.58

Increases to Estimate					
Date	Time	OK'd By	Phone	Emp.	Increase

LABOR	.00
PARTS	126.08
SUBLETS	.00
CALIF BATTERY TAX	.00
SUB TOTAL	126.08
TAX	11.50
TOTAL	<u>137.58</u>

Parts & labor conditionally guaranteed 4,000 mi./ 90 days.

I hereby authorize DEJUNG MOTORSPORT to perform the repair work listed above along with necessary materials. You and your employees may operate the above vehicle for purposes of testing, inspection, or delivery at my risk. An express mechanics lien is acknowledged on above vehicle to secure the amount of repairs. Thereto it is understood that this company assumes no responsibility for loss or damage by theft or fire to vehicles placed with them for storage, sale, repair, or while road testing.

Authorized by : _____ Date : _____

JE JUNG MOTORSPORT

59 PORTAL ST SUITE A

OTATI, CA 94931

07-664-8002

AR #ARD 101025

PA# CAL000064429

R/O # : 17386

Name :

Date : 05/23/2018

License # : 1PCY741

Make : PORSCHE

Model : CARRERA

Year : 86

Odometer : 270210

Save Parts : NO

VIN : WPOAB0916GS120538

~~JAMON BROWN~~

ABOR

AMOUNT

Major service:

Tune up

Adjust valves

Full service

720.00

L&R left fog lamp bulb.

ARTS All parts new unless stated used or remanufactured

		PRICE	QTY	AMOUNT
OC 54	OIL FILTER	15.44	1	15.44
30 110 393 00	AIR FILTER	27.57	1	27.57
28 110 253 06	FUEL FILTER	45.48	1	45.48
PK 03	V/C GASKET KIT	69.44	1	69.44
055	SPARK PLUG	11.90	6	71.40
30 602 902 01	ROTOR	27.50	1	27.50
30 602 919 00	CAP	88.64	1	88.64
5	**CASTROL OIL(PTS.)	3.50	22	77.00
5L5-S	GEAR OIL-SWEPKO 1/2 PT	3.50	13	45.50
1	TECHRON	9.00	1	9.00
3	WASHER SOLVENT	3.50	1	3.50

DE JUNG MOTORSPORT

59 PORTAL ST SUITE A

OTATI, CA 94931

07-664-8002

AR #ARD 101025

PA# CAL000064429

~~AMON BROWN~~

CA

ome: ~~829-5422~~

ork: ~~544-0784~~

ther:

R/O # : 17386

Page : 2

Name :

Date : 05/23/2018

License # : IPCY741

Make : PORSCHE

Model : CARRERA

Year : 86

Odometer : 270210

Save Parts : NO

VIN : WPOAB0916GS120538

ARTS All parts new unless stated used or remanufactured
B BULB

PRICE	QTY	AMOUNT
7.24	1	7.24

RECOMMENDATIONS AND TECHNICIANS NOTES

REAR VIEW MIRRORS/WIRING IN DRIVERS DOOR JAM ?

Original Estimate : 1,262.36

Increases to Estimate					
Date	Time	OK'd By	Phone	Emp.	Increase

LABOR	720.00
PARTS	487.71
SUBLETS	.00
CALIF BATTERY TAX	.00
HAZARDOUS MATERIALS	10.15
SUB TOTAL	1,217.86
TAX	44.50
TOTAL	<u>1,262.36</u>

Parts & labor conditionally guaranteed 4,000 mi./ 90 days.

By authorizing DEJUNG MOTORSPORT to perform the repair work listed above along with necessary materials. You and your employees may operate the above vehicle for purposes of testing, inspection, or delivery at my risk. An express mechanics lien is acknowledged on above vehicle to secure the amount of repairs. Thereto it is understood that this company assumes no responsibility for loss or damage by theft or fire to vehicles placed with them for storage, sale, repair, or while road testing.

Authorized by : _____ Date : _____

JE JUNG MOTORSPORT

59 PORTAL ST SUITE A
OTATI, CA 94931
37-664-8002
AR #ARD 101025
PA# CAL000064429

~~AMON BROWN~~

CA
ome: ~~829-5422~~
ork: ~~544-0784~~
her:

R/O # : 17056
Name
Date : 08/25/2017
License # : 1PCY741
Make : PORSCHE
Model : CARRERA
Year : 86
Odometer : 265464 Save Parts : NO
VIN : WPOAB0916GS120538

LABOR

	AMOUNT
change engine oil and filter.	
check transaxle oil level.	144.00
inspect brakes.	
check tire pressures.	
check lights.	
check brake fluid level.	
check out non op brake lights:	
Oxidation at the fuse panel, brake light position.	
replace both license light bulbs.	
&R alt/fan belt.	36.00

ARTS	All parts new unless stated used or remanufactured	PRICE	QTY	AMOUNT
C 54	OIL FILTER	20.54	1	20.54
)	**ENGINE OIL(PTS.)	3.00	22	66.00
502227	COPPER WASHER	.90	2	1.80
	TECHRON	9.00	1	9.00
;	WASHER SOLVENT	3.50	1	3.50
07	BULB	1.50	2	3.00
5X710	BELT	7.95	1	7.95

DE JUNG MOTORSPORT

59 PORTAL ST SUITE A
OTATI, CA 94931
07-664-8002
AR #ARD 101025
PA# CAL000064429

R/O # : 17056

Page : 2

Name :
Date : 08/25/2017
License # : 1PCY741
Make : PORSCHE
Model : CARRERA
Year : 86

Odometer : 265464 Save Parts : NO
VIN : WPOAB0916GS120538

AMON BROWN

CA
Phone: 829-5422
Work: 544-0784
Fax:

RECOMMENDATIONS AND TECHNICIANS NOTES
REAR VIEW MIRRORS/WIRING IN DRIVERS DOOR JAM ?

Original Estimate : 310.19

Date	Increases to Estimate				
	Time	OK'd By	Phone	Emp.	Increase

LABOR	180.00
PARTS	111.79
SUBLETS	.00
CALIF BATTERY TAX	.00
HAZARDOUS MATERIALS	8.20
SUB TOTAL	299.99
TAX	10.20
TOTAL	310.19

& labor conditionally guaranteed 4,000 mi./ 90 days.

I hereby authorize DEJUNG MOTORSPORT to perform the repair work listed above along with necessary materials. You and your employees may operate the above vehicle for purposes of testing, inspection, or delivery at my risk. An express mechanics lien is acknowledged on above vehicle to secure the amount of repairs. There to it is understood that my company assumes no responsibility for loss or damage by theft or fire to vehicles placed with them for storage, sale, repair, or while road testing.

Authorized by : _____ Date : _____

WESTERN AUTOBODY
FINAL BILL
 5800 GUERNEVILLE ROAD
 SEBASTOPOL, CA 95472
 (707) 829-2477 FAX: (707) 829-3114
 info@westernautobody.com

BROWN, DAMO
 Estimate: 1188
 Repair Order: 808

Customer: Insured	Vehicle:	Ins. Company:
BROWN, DAMON 8637 GRATON RD SEBASTOPOL, CA 95472-2404 Home: (707) 544-0784 Work: (707) 829-5422	PORS 911 2D CPE YEAR: 1986 Color: grey License: 1PCY741 CA Prod Date: 09/01/1985 Mileage In: 271326 Mileage Out: 271326 VIN: WP0AB0916GS120538 Sched. Arrival Date: 07/18/18 Arrival Date: 07/18/18 Billed Date: 10/09/18 Delivery Date: 10/09/18 Drivable: Yes	

Written by: Schliemann, Tony
 Item

Item	Price	Ext. Price	Labor Units	Paint Units	PT	BT
1 FRONT BUMPER						
2 OVERHAUL O/H bumper assy						
3 REMOVE/RE-INSTALL R&I bumper assy			2.5 B			
4 REPAIR Face bar w/washer			Incl.			
5 Add for Clear Coat			1.0 B	2.0		
6 REMOVE/RE-INSTALL Face bar upper seal				0.8		
7 REMOVE/RE-INSTALL Molding			Incl.			
8 REMOVE/RE-INSTALL Valance panel lower w/o Club Sport			Incl.			
9 REFINISH Valance panel lower w/o Club Sport						
10 REMOVE/RE-INSTALL LT Boot				1.0		
11 REMOVE/RE-INSTALL RT Boot			Incl.			
12 FRONT LAMPS			Incl.			
13 REMOVE/RE-INSTALL LT Door primed						
14 REMOVE/REPLACE LT Door seal	9.78	9.78	0.2 B			
15 BLEND LT Door primed						O
16 REMOVE/RE-INSTALL RT Door primed				0.2		
17 BLEND RT Door primed			0.2 B			
18 REMOVE/REPLACE RT Door seal	9.83	9.83		0.2		
19 REMOVE/RE-INSTALL LT Park lamp						O
20 REMOVE/RE-INSTALL RT Park lamp			Incl.			
21 REMOVE/RE-INSTALL LT Fog lamp assy clear lens			Incl.			
22 REMOVE/RE-INSTALL RT Fog lamp assy clear lens			Incl.			
23 REMOVE/RE-INSTALL Nozzle			Incl.			
24 REMOVE/RE-INSTALL Nozzle			Incl.			
25 FENDER						
26 BLEND LT Fender Carrera w/metal fuel filler cu				1.5		
27 BLEND Fuel door				0.1		
28 REMOVE/RE-INSTALL RT R&I fender assy (LOOSEN)			1.5 B			
30 Deduct for Overlap						
37 REMOVE/RE-INSTALL LT R&I fender assy (LOOSEN)			-0.5 B			
39 Deduct for Overlap			1.5 B			
46 BLEND RT Fender Carrera w/plastic fuel filler			-0.5 B			
47 REMOVE/REPLACE LT Fender seal	3A 10.56	10.56		1.4		
48 REMOVE/REPLACE RT Fender seal	3A 10.56	10.56	Incl.			O
49 COWL & WINDSHIELD			Incl.			O
50 REFINISH Cowl top panel w/windshield frame, coupe				2.0		
51 Add for Clear Coat				0.8		
52 REMOVE/RE-INSTALL LT Wiper arm			Incl.			

Written by: Schliemann, Tony

Item	Price	Ext. Price	Labor Units	Paint Units	PT	BT
53 REMOVE/RE-INSTALL RT Wiper arm			Incl.			
54 REMOVE/REPLACE LT WIPER ARM CAP 3A	5.53	5.53	Incl.		A	
55 REMOVE/REPLACE RT WIPER ARM CAP 3A	5.53	5.53	Incl.		A	
56 REMOVE/REPLACE Washer pump windshield wipe3A large reser	118.23	118.23	0.5 B		O	
57 INSTRUMENT PANEL						
62 ROOF & BACK GLASS						
63 REPAIR Roof assy w/sunroof (strip)			4.0 B	3.5		
64 Overlap Major Non-Adj. Panel				-0.2		
65 Add for Clear Coat				0.7		
66 REMOVE/RE-INSTALL Back glass Porsche, tinted w/heater			2.2 B			
67 REMOVE/REPLACE Back glass rubber channel	160.17	160.17			O	
68 REFINISH RT Reveal molding half				0.2		
69 REFINISH LT Reveal molding half				0.2		
70 REPAIR Outer panel (STRIP SUNROOF)			1.5 B	1.5		
71 Overlap Major Adj. Panel				-0.4		
72 Add for Clear Coat				0.2		
73 REMOVE/RE-INSTALL Outer panel 3A			2.0 B			
74 REMOVE/REPLACE SUNROOF FT FELT SEAL 3A	77.99	77.99	0.3 B		A	
75 REMOVE/REPLACE FELT SUNROF SEAL 3A	50.32	50.32			A	
76 ROCKER PANEL & FLOOR						
77 REMOVE/RE-INSTALL LT Rocker molding turbo w/o 930S			0.5 B			
78 REFINISH LT Rocker panel 3A			Incl.			
79 REFINISH RT Rocker panel 3A			Incl.			
80 DOOR						
81 REMOVE/RE-INSTALL LT Mirror			1.5 B			
82 REMOVE/RE-INSTALL LT Belt molding coupe			0.5 B			
83 REFINISH LT Belt molding coupe				0.1		
84 REPAIR LT Outer panel (STRIP)			3.5 B	2.3		
85 Overlap Major Adj. Panel				-0.4		
86 Add for Clear Coat				0.4		
87 REMOVE/RE-INSTALL LT Handle, outside			0.5 B			
88 QUARTER PANEL						
89 REMOVE/RE-INSTALL LT Qtr glass Porsche clear			1.5 B			
94 REFINISH LT Quarter panel Carrera				2.7		
95 Overlap Major Adj. Panel				-0.4		
96 Add for Clear Coat				0.5		
97 REMOVE/RE-INSTALL LT Extension Turbo			1.0 B			
98 REMOVE/RE-INSTALL RT Extension Turbo			Incl.			
99 REFINISH LT Extension Turbo				1.0		
100 Overlap Major Adj. Panel				-0.4		
101 Add for Clear Coat				0.1		
102 REFINISH RT Extension Turbo				1.0		
103 Overlap Major Non-Adj. Panel				-0.2		
104 Add for Clear Coat				0.2		
105 REMOVE/RE-INSTALL LT Extension seal turbo 3A			Incl.			
106 REMOVE/RE-INSTALL RT Extension seal turbo 3A			Incl.			
107 ENGINE LID						
108 REMOVE/RE-INSTALL Vent grille			0.5 B			
111 REFINISH Engine lid				1.5		
112 Overlap Major Adj. Panel				-0.4		
113 Add for Clear Coat				0.2		
114 REMOVE/RE-INSTALL Nameplate "CARRERA" 1A			0.2 B			
115 REMOVE/REPLACE CLEAN & RETAPE NAMEPLATE 1A	2.00	2.00	0.2 B			
116 REMOVE/RE-INSTALL R&I lid 3A			0.5 B			
117 REAR LAMPS						
118 REMOVE/RE-INSTALL LT Tail lamp assy			0.5 B			
119 REMOVE/REPLACE LT Gasket surround	23.25	23.25			O	
120 REMOVE/REPLACE RT Gasket surround	23.25	23.25			O	

Written by: Schliemann, Tony

Item	Price	Ext. Price	Labor Units	Paint Units	PT	BT
121 REMOVE/REPLACE LT Lens						
122 REMOVE/REPLACE RT Lens	168.59	168.59	0.1 B		O	
123 REMOVE/RE-INSTALL High mount lamp	168.59	168.59	0.1 B		O	
124 OVERHAUL O/H bumper assy			0.2 B			
125 REMOVE/RE-INSTALL License lamp			2.5 B			
126 REAR BUMPER R&I OVERLAP FROM OTHER JOB			Incl.			
127 REMOVE/REPLACE License lamp	1A 25.39	25.39	-1.3 B			
128 REMOVE/REPLACE License lamp	1A 25.39	25.39	Incl.		O	
129 REAR BUMPER			Incl.		O	
130 REMOVE/REPLACE Valance panel seal	26.10	26.10				
131 REMOVE/RE-INSTALL R&I bumper assy			Incl.		O	
132 REPAIR Face bar (STRIP)			Incl.			
133 Add for Clear Coat			1.5 B	2.0		
134 REMOVE/REPLACE LT Guard	586.87	586.87		0.8		
135 REMOVE/REPLACE RT Guard	586.87	586.87	Incl.		O	
136 REMOVE/RE-INSTALL LT Boot			Incl.		O	
137 REMOVE/RE-INSTALL RT Boot			Incl.			
138 REMOVE/REPLACE LT Cushion	108.75	108.75	Incl.			
139 REMOVE/REPLACE RT Cushion	110.08	110.08	Incl.		O	
140 REPAIR Valance panel Turbo					O	
141 Overlap Major Non-Adj. Panel			1A 2.0 B	1.2		
142 Add for Clear Coat				-0.2		
143 INTERIOR TRIM				0.2		
144 REMOVE/RE-INSTALL LT Door panel leather						
145 REMOVE/RE-INSTALL LT Qtr trim panel coupe cloth			1.0 B			
146 HOOD			0.8 B			
147 REMOVE/RE-INSTALL R&I hood assy						
148 REPAIR Hood			3A 0.8 B			
149 REMOVE/RE-INSTALL Emblem			3A Incl.			
150 REMOVE/RE-INSTALL Weatherstrip around lid			3A Incl.			

FINAL BILL SUMMARY

	Regular	Supp	Total		Regular	Supp	Total
New (OEM) Parts:	\$3,565.63	(\$1,393.37)	\$2,172.26	Parts Total:	\$3,772.98	(\$1,459.35)	\$2,313.63
Other parts:	\$207.35	(\$65.98)	\$141.37	Labor Total:	\$5,420.80	\$114.40	\$5,535.20
				Paint/Material:	\$1,121.40	\$50.40	\$1,171.80
				Tax:	\$397.67	(\$114.48)	\$283.19

	Reg Units	Supp Units	Rate	Amount
Body :	34.9	0.1	\$88.00	\$3,080.00
Paint :	26.7	1.2	\$88.00	\$2,455.20

Total: \$9,303.82

	PAYMENTS	AMT DUE	SUBTOTAL	SUPPLEMENTS	TOTAL
BROWN, DAMON PAYABLE REPAIR TOTAL	\$0.00	\$9,303.82	\$10,712.85	(\$1,409.03)	\$9,303.82

AUTHORIZED AND ACCEPTED: You are hereby authorized to make the above specified repairs. I understand that payment in full will be due upon release of the vehicle, including additional supplemental damage charges, and hereby grant you and/or your employees permission to operate the vehicle herein described on the street, highway or elsewhere for the purpose of testing and/or inspection. An express mechanic's lien is hereby acknowledged on the above vehicle to secure the amount of repairs thereto. You will not be held responsible for loss or damage to vehicle or articles left in vehicle in case of fire, theft, accident or any other cause beyond your control. Parts removed from the above vehicle will be discarded unless otherwise instructed.

Repair Order authorized by _____ Date _____

PAID

OCT 11 2018

16891

WESTERN AUTOBODY
FINAL BILL
 5800 GUERNEVILLE ROAD
 SEBASTOPOL, CA 95472
 (707) 829-2477 FAX:(707) 829-3114
 info@westernautobody.com

BROWN, DAMON
 Estimate: 11 886
 Repair Order: 8063

Page 1
 Printed 10/09/18 4:15 PM
 Created 07/10/2018

Customer: Insured BROWN, DAMON 8687 GRATON RD SEBASTOPOL, CA 95472-2404 Home: (707) 544-0784 Work: (707) 829-5422	Vehicle: PORS 911 2D CPE YEAR: 1986 Color: grey License: 1PCY741 CA Prod Date: 09/01/1985 Mileage In: 271326 Mileage Out: 271326 VIN: WPOAB0916GS120538 Sched. Arrival Date: 07/18/18 Arrival Date: 07/18/18 Billed Date: 10/09/18 Delivery Date: 10/09/18 Drivable: Yes	Ins. Company: STATE FARM INSURANCE COMPANY Claim Number: 05-4634-C8101 Phone: (855) 341-8184 Date of Loss: 06/18/18 Deductible: 500.00
---	--	--

Written by: Schliemann, Tony

Item	Price	Ext. Price	Labor Units	Paint Units	PT	BT
1 ROCKER PANEL & FLOOR						
2 REMOVE/RE-INSTALL RT Rocker molding turbo w/o 930S			0.5 B			
3 DOOR						
4 BLEND RT Outer panel				1.0		
5 REMOVE/RE-INSTALL RT Belt molding coupe			0.5 B			
6 REMOVE/RE-INSTALL RT Mirror			1.5 B			
7 REMOVE/RE-INSTALL RT Handle, outside			0.5 B			
8 QUARTER PANEL						
9 REPAIR RT Quarter panel turbo w/o 930S			10.0 B	2.7		
10 REPAIR COLLISION PULL			1.0 B			
11 REPAIR SET UP PULL			1.0 B			
12 REMOVE/RE-INSTALL RT Qtr glass Porsche clear			1.5 B			
13 REMOVE/RE-INSTALL RT Extension Turbo			2.0 B			
14 Add for Clear Coat	1A					
15 REMOVE/RE-INSTALL RT Molding belt	2A		0.4 B	1.1		
16 REAR LAMPS			0.5 B			
17 REMOVE/RE-INSTALL RT Tail lamp assy						
18 REAR BUMPER			0.5 B			
19 REMOVE/RE-INSTALL R&l bumper assy			1.3 B			
20 INTERIOR TRIM						
21 REMOVE/RE-INSTALL RT Door panel leather			1.0 B			
22 REMOVE/RE-INSTALL RT Qtr trim panel coupe cloth			0.8 B			
23 MISCELLANEOUS OPERATIONS						
24 REMOVE/REPLACE Cover car/bag			0.2 B			
25 REMOVE/REPLACE CORROSION PROTECTION	9.00	9.00	0.3 B			
26 SU HAZARDOUS WASTE DISPOSAL	3.00	3.00				
27 REPAIR TINT COLOR			0.5 B		H	

FINAL BILL

BROWN, DAMON
Estimate 11886
Repair Order 8063

FINAL BILL SUMMARY

Other parts:	Regular	Supp	Total		Regular	Supp	Total
	\$9.00	\$0.00	\$9.00	Parts Total:	\$9.00	\$0.00	\$9.00
				Labor Total:	\$2,358.40	\$132.00	\$2,490.40
				Paint/Material:	\$155.40	\$46.20	\$201.60
				Hazardous Disposal:	\$3.00	\$0.00	\$3.00
				Tax:	\$13.36	\$3.75	\$17.11

	Reg Units	Supp Units	Rate	Amount
Body	23.1	0.4	\$88.00	\$2,068.00
Paint	3.7	1.1	\$88.00	\$422.40

Total: \$2,721.11

STATE FARM INSURANCE COMPANY	PAYMENTS	AMT DUE	SUBTOTAL	SUPPLEMENTS	TOTAL
PAYABLE REPAIR TOTAL	\$0.00	\$2,221.11	\$2,039.16	\$181.95	\$2,221.11
BROWN, DAMON PAYABLE REPAIR TOTAL	\$0.00	\$500.00	\$500.00	\$0.00	\$500.00

AUTHORIZED AND ACCEPTED: You are hereby authorized to make the above specified repairs. I understand that payment in full will be due upon release of the vehicle, including additional supplemental damage charges, and hereby grant you and/or your employees permission to operate the vehicle herein described on the street, highway or elsewhere for the purpose of testing and/or inspection. An express mechanic's lien is hereby acknowledged on the above vehicle to secure the amount of repairs thereto. You will not be held responsible for loss or damage to vehicle or articles left in vehicle in case of fire, theft, accident or any other cause beyond your control. Parts removed from the above vehicle will be discarded unless otherwise instructed.

Repair Order authorized by _____ Date _____

PAID
OCT 11 2018
16891

R# AD227345
ID# 43-2006693

or Dept Codes: B-Body D-Detail I-Hold E- F-Frame G-Sublet M-Mechanical P-Paint S-Blue Printing A-Aluminum 1-Feather, Prime & Block
ser-defined2 3-User-defined3

- Price Types: O - OEM; A - Aftermarket; V - Salvage; R - Remanufactured; Space - No Type
L - Labor; M - Material; H - Hazardous; S - Storage; T - Towing; U - Sublet

- Billing Types: No Code - Insurance Charge; CC - Customer Charge; BT - Betterment; AP - Appearance Allowance
PD - Prior Damage; NC - No Charge

One Data, Copyright 1995 CCC Information Services (*) Indicates Estimator Judgement. Underline Indicates Supplement.
elements of data used to calculate this Estimate were obtained from a CCC Database.

Calculations of the Estimate are performed by a computer program created by YADA Systems, Inc.

ProfitNet [Ver. 14.00.1128] © 1989-2017 YADA Systems, Inc. All rights reserved. Licensed by WESTERN AUTOBODY

DEJUNG MOTORSPORT

59 PORTAL ST SUITE A

COTATI, CA 94931

707-664-8002

BAR #ARD 101025

PA# CAL000064429

~~DAMON BROWN~~

CA

Home: 829-5422

Work: 544-0784

Other:

R/O # : 16910

Name :

Date :

License # : 1PCY741

Make : PORSCHE

Model : CARRERA

Year : 86

Odometer : 263729

Save Parts : NO

VIN : WPOAB0916GS120538

LABOR

AMOUNT

R&R battery.

30.00

R&R right, outside mirror, glass.

PARTS All parts new unless stated used or remanufactured

911 731 035 08

GLASS-OUTER MIRROR

PRICE

QTY

AMOUNT

118.88

1

118.88

MTP-49/H8

BATTERY

191.00

1

191.00

RECOMMENDATIONS AND TECHNICIANS NOTES

REAR VIEW MIRRORS/WIRING IN DRIVERS DOOR JAM ?

Original Estimate : 369.16

Date	Increases to Estimate				
	Time	OK'd By	Phone	Emp.	Increase

parts & labor conditionally guaranteed 4,000 mi./ 90 days.

LABOR	30.00
PARTS	309.88
SUBLETS	.00
CALIF BATTERY TAX	1.00
SUB TOTAL	340.88
TAX	28.28
TOTAL	369.16

I hereby authorize DEJUNG MOTORSPORT to perform the repair work listed above along with necessary materials. You and your employees may operate the above vehicle for purposes of testing, inspection, or delivery at my risk. An express mechanics lien is acknowledged on above vehicle to secure the amount of repairs. Thereto it is understood that this company assumes no responsibility for loss or damage by theft or fire to vehicles placed with them for storage, sale, repair, or while road testing.

Authorized by : _____ Date : _____

JE JUNG MOTORSPORT

59 PORTAL ST SUITE A

OTATI, CA 94931

07-664-8002

AR #ARD 101025

PA# CAL000064429

~~JAMON BROWN~~

CA

ome: ~~829-5422~~

ork: ~~544-0784~~

ther:

R/O # : 16575

Name : I

Date : 08/08/2016

License # : 1PCY741

Make : PORSCHE

Model : CARRERA

Year : 86

Odometer : 259107

Save Parts : NO

VIN : WPOAB0916GS120538

ABOR

AMOUNT

Test drive with customer.

****Detonation occurred during test drive****

120.00

Inspect ignition distributor for bushing wear. None found.

Switch catalytic converter with a used unit (customers original). The engine seems to be running

OK and there is no more detonation.

R&I idle control valve. Clean out idle valve.

8/2016

hour 0 minutes

59107 miles

1/15/2016

60877 miles

120.00

Change engine oil and filter.

Check transaxle oil level.

Inspect brakes.

Check tire pressures.

Check lights.

Check brake fluid level.

R&R idle control valve.

Adjust "baseline" idle speed.

24.00

Check out non returning clutch pedal.

Adjust clutch lever adjustment.

Adjust clutch cable.

36.00

DEJUNG MOTORSPORT

59 PORTAL ST SUITE A
 OTATI, CA 94931
 07-664-8002
 AR #ARD 101025
 PA# CAL000064429

DAMON BROWN

CA

Home: 829-5422

Work: 544-0784

Other:

R/O # : 16575

Page : 2

Name :

Date : 08/08/2016

License # : 1PCY741

Make : PORSCHE

Model : CARRERA

Year : 86

Odometer : 259107

Save Parts : NO

VIN : WPOAB0916GS120538

ABOR

AMOUNT

Check out non op, automatic locking at the drivers door.

150.00

&I the door panel.

Trace the problem to a broken actuator rod, actuator to latch assembly.

&R actuator rod.

ARTS	DESCRIPTION	PRICE	QTY	AMOUNT
OC 54	OIL FILTER	20.54	1	20.54
5	**CASTROL OIL(PTS.)	3.50	22	77.00
602227	COPPER WASHER	.90	2	1.80
03	WASHER SOLVENT	3.50	1	3.50
030 606 161 00	IDLE VALVE	363.06	1	363.06
064 537 571 00	OPERATING ROD	4.18	1	4.18

RECOMMENDATIONS AND TECHNICIANS NOTES

REAR VIEW MIRRORS/WIRING IN DRIVERS DOOR JAM ?

Original Estimate : 971.76

Increases to Estimate					
Date	Time	OK'd By	Phone	Emp.	Increase

LABOR	450.00
PARTS	470.08
SUBLETS	.00
	.00
HAZARDOUS MATERIALS	8.20
SUB TOTAL	928.28
TAX	43.48
TOTAL	971.76

Parts & labor conditionally guaranteed 4,000 mi / 90 days.

By authorizing DEJUNG MOTORSPORT to perform the repair work listed above along with necessary materials. You and your employees may operate the above vehicle for purposes of testing, inspection, or delivery at my risk. An express mechanics lien is acknowledged on above vehicle to secure the amount of repairs. Thereto it is understood that this company assumes no responsibility for loss or damage by theft or fire to vehicles placed with them for storage, sale, repair, or while road testing.

Authorized by : _____ Date : _____

THE JUNG MOTORSPORT

59 PORTAL ST SUITE A

OTATI, CA 94931

7-664-8002

AR #ARD 101025

PA# CAL000064429

AMON BROWN

LA

ome: 829-5422

ork: 544-0784

ther:

R/O # : 16312

Name :

Date : 12/30/2015

License # : 1PCY741

Make : PORSCHE

Model : CARRERA

Year : 86

Odometer : 255324

Save Parts : NO

VIN : WPOAB0916GS120538

ABOR

AMOUNT

Change engine oil and filter. 120.00
 Check transaxle oil level.
 Inspect brakes.
 Check tire pressures.
 Check lights.
 Check brake fluid level.

Check for erratic reading oil pressure gauge. 60.00
 Trace the problem to a bad terminal to wire connection.
 Replace terminal.

R&R right fog lamp, bulb.

Install 2 jack hole, plugs.

ARTS	All parts new unless stated used or remanufactured	PRICE	QTY	AMOUNT
DC 54	OIL FILTER	20.34	1	20.34
0	**ENGINE OIL(PTS.)	3.00	22	66.00
1602227	COPPER WASHER	.90	2	1.80
01	TECHRON	9.00	1	9.00
03	WASHER SOLVENT	3.50	1	3.50
03	BULB	6.32	1	6.32

DEJUNG MOTORSPORT

59 PORTAL ST SUITE A
 OTATI, CA 94931
 7-664-8002
 AR #ARD 101025
 PA# CAL000064429

~~AMON BROWN~~

LA
~~me: 829-5422~~
~~ork: 544-0784~~
 ther:

R/O # : 16312 Page : 2
 Name :
 Date : 12/30/2015
 License # : 1PCY741
 Make : PORSCHE
 Model : CARRERA
 Year : 86
 Odometer : 255324 Save Parts : NO
 VIN : WPOAB0916GS120538

ARTS All parts new unless stated used or remanufactured

		PRICE	QTY	AMOUNT
11 559 149 01	PLUG	6.87	2	13.74
	TERMINAL	.60	1	.60

Original Estimate : 320.72

Increases to Estimate					
Date	Time	OK'd By	Phone	Emp.	Increase

LABOR	180.00
PARTS	121.30
SUBLETS	.00
	.00
HAZARDOUS MATERIALS	8.20
SUB TOTAL	309.50
TAX	11.22
TOTAL	<u>320.72</u>

Parts & labor conditionally guaranteed 4,000 mi./ 90 days.

I hereby authorize DEJUNG MOTORSPORT to perform the repair work listed above along with necessary materials. You and your employees may operate the above vehicle for purposes of testing, inspection, or delivery at my risk. An express mechanics lien is acknowledged on above vehicle to secure the amount of repairs. Thereto it is understood that this company assumes no responsibility for loss or damage by theft or fire to vehicles placed with them for storage, sale, repair, or while road testing.

Authorized by : _____ Date : _____

DEJUNG MOTORSPORT

59 PORTAL ST SUITE A
 OTATI, CA 94931
 07-664-8002
 AR #ARD 101025
 PA# CAL000064429

R/O # : **16244**
 Name : J
 Date : 10/20/2015
 License # : 1PCY741
 Make : PORSCHE
 Model : CARRERA
 Year : 86
 Odometer : 253796 Save Parts : NO
 VIN : WPOAB0916GS120538

AMON BROWN

JA
 Home: 829-5422
 Work: 544-0784
 Ther:

LABOR	AMOUNT
Now in.	396.00
Check out non op clutch.	
The clutch pedal shaft has worn away at the clevis pivot point.	
L&I the pedal cluster.	
L&R the clutch pedal shaft.	
Install a clutch pedal assist spring (original is not there).	
L&R the clutch cable.	

PARTS All parts new unless stated used or remanufactured	PRICE	QTY	AMOUNT
130 423 027 01 SHAFT	52.31	1	52.31
99 166 001 02 CLIP	2.68	1	2.68
111 423 305 06 SPRING	31.80	1	31.80
130 423 401 05 CLUTCH CABLE	165.90	1	165.90

SUBLETS	AMOUNT
Now	97.00

Original Estimate : 769.06

Increases to Estimate					
Date	Time	OK'd By	Phone	Emp.	Increase

LABOR	396.00
PARTS	252.69
SUBLETS	97.00
	.00
SUB TOTAL	745.69
TAX	23.37
TOTAL	<u>769.06</u>

Parts & labor conditionally guaranteed 4,000 mi./ 90 days.

By authorizing DEJUNG MOTORSPORT to perform the repair work listed above along with necessary materials. You and your employees may operate the above vehicle for purposes of testing, inspection, or delivery at my risk. An express mechanics lien is acknowledged on above vehicle to secure the amount of repairs. Thereto it is understood that this company assumes no responsibility for loss or damage by theft or fire to vehicles placed with them for storage, sale, repair, or while road testing.

Authorized by : _____ Date : _____

2815 Alton Lane
Santa Rosa, CA 95403

000015053

Order Date 07/30/15 11:20 am
Paid: 07/31/15 05:54 pm

707.544.3020 • fax 707.535.0901

BR
SANTA ROSA CA 95404
Home Phone: 4

86 PORSCHE 911 GREY
252325 Mi.
Lic: 1PCX741/CA H6Cyl 3.2
Vin: 1P3BP36K7GC158178 09/85
Eq: AC PS FI

Quotes
1 07/31/15 05:55pm 739.62
DAMON in person.

**FOR FRI 7/31 @ 5PM **
205/55/R16 MICHELIN A/S 3 (2)
225/50/R16 MICHELIN A/S 3 (2)

REFERRED BY STEVE DEJUNG.

MOUNT & BALANCE TIRES Labor: \$80.00

REMOVE OLD TIRE(S), MOUNT & BALANCE NEW TIRE(S).

LUG TORQUE = 85 FT/LBS

TIRE PRESSURE = 29/36 PSI

***** ALL TPMS SYSTEM ARE VERIFIED FOR PROPER OPERATION BY MEANS OF THE TPMS
WARNING LIGHT OR WITH THE USE OF SPECIAL TPMS TOOLS PRIOR TO TIRE INSTALLATION.
THE CUSTOMER IS ADVISED IF THERE ARE ANY PROBLEMS AND IF ADDITIONAL

DIAGNOSIS WILL IS REQUIRED. *****

***** ALL CUSTOMERS ARE ADVISED AT THE TIME OF TIRE INSTALLATION WHEATHER AN
ALIGNMENT IS NECESSARY TO PREVENT PREMATURE TIRE WEAR

***** UNLESS OTHERWISE SPECIFIED.. ALL WHEELS HAVE ROADRASH *****
***** ALIGNMENTS ARE RECCOMENDED ON ALL NEW TIRE INSTALLATIONS *****
***** ALL CUSTOMERS ARE ASKED IF THEY WANT NITROGEN IN PLACE OF JUST AIR *****
***** ALL WHEELS RECEIVE NEW VALVE STEMS UNLESS THEY HAVE TPMS INSTALLED
OR METAL VALVE STEMS*****
***** CUSTOMERS MAY REQUEST TAPE-ON WHEEL WEIGHTS INSTEAD OF CLIP ON IF POSSIBLE ****

***** ALL WHEELS ARE TORQUED TO FACTORY SPECIFICATIONS *****
***** ALL TIRE PRESSURES ARE SET ACCORDING TO THE MANUFACTURES SPECIFICATIONS
LOCATED ON THE DOOR JAM LABEL *****

>> ABSOLUTELY NO WARRANTY ON COMPETITION OR TRACKED TIRES USED IN ANY CATAGORY!.

VALVE STEM	NEW-N	4.0 @	2.00 = \$	8.00
205//55//R16	MICHELIN A/S 3-N	2.0 @	129.00 = \$	258.00
225//50//R16	MICHELIN A/S 3-N	2.0 @	139.00 = \$	278.00
				544.00

----->----->----->-----Continued on the next page----->----->----->-----

ALL PARTS ARE NEW UNLESS SPECIFIED OTHERWISE	ALL PARTS REMOVED WILL BE DISCARDED UNLESS INSTRUCTED OTHERWISE <input type="checkbox"/> SAVE <input type="checkbox"/> DISCARD
CREDIT CARDS ACCEPTED AR # ARD215630	By signing below, I hereby authorize the repair work to be done along with the necessary material, and hereby grant your employees permission to operate the vehicle herein described on streets, highways and elsewhere for the purpose of testing and/or inspection. If automobile is returned to customer before authorized service is performed, a diagnostic and handling charge will be made. I have read and understand the statements and estimates made on this side and the reverse of this/these pages (connected with this vehicle). I authorize service to be performed, including sublet work, and acknowledge receipt of this estimate. Customer is hereby notified that the said property is not insured or protected against loss occasioned by theft, fire or vandalism while the property remains with the Repair Garage.
WE RESERVE THE RIGHT TO REFUSE ANY PERSONAL CHECKS	CUST. SIG. X
acknowledge notice and oral approval of an increase in the original estimated price. X	I ACKNOWLEDGE RECEIPT OF AND AGREE TO THE TERMS AND CONDITIONS OF THIS CONTRACT.

READ IMPORTANT INFORMATION ON REVERSE SIDE

2815 Alton Lane
Santa Rosa, CA 95403

000015053

Order Date 07/30/15 11:20 am
Paid: 07/31/15 05:54 pm

707.544.3020 • fax 707.535.0901

Payments to Pagnano's Automotive

Cost Summary

Status: Paid Work Order

Payments: \$739.62

1 07/31/15 739.62 Discover

Labor	80.00
Parts	544.00
TIRE DISPOSAL FEE	12.00
CA TIRE FEE	7.00
FREIGHT IN	51.74
Subtotal	694.74
Tax	44.88
Total	\$739.62
Payments	739.62
Bal Due	0.00

Thank you for choosing Pagnano's Automotive

ALL PARTS ARE NEW UNLESS SPECIFIED OTHERWISE		ALL PARTS REMOVED WILL BE DISCARDED UNLESS INSTRUCTED OTHERWISE <input type="checkbox"/> SAVE <input type="checkbox"/> DISCARD	
CREDIT CARDS ACCEPTED		By signing below, I hereby authorize the repair work to be done along with the necessary material, and hereby grant your employees permission to operate the vehicle herein described on streets, highways and elsewhere for the purpose of testing and/or inspection. If automobile is returned to customer before authorized service is performed, a diagnostic and handling charge will be made. I have read and understand the statements and estimates made on this side and the reverse of this/these pages (connected with this vehicle). I authorize service to be performed, including sublet work, and acknowledge receipt of this estimate. Customer is hereby notified that the said property is not insured or protected against loss occasioned by theft, fire or vandalism while the property remains with the Repair Garage.	
WE RESERVE THE RIGHT TO REFUSE ANY PERSONAL CHECKS		CUST. SIG. X	
acknowledge notice and oral approval of an increase in the original estimated price.	X	I ACKNOWLEDGE RECEIPT OF AND AGREE TO THE TERMS AND CONDITIONS OF THIS CONTRACT.	
CUSTOMER ACKNOWLEDGEMENT			

READ IMPORTANT INFORMATION ON REVERSE SIDE

DE JUNG MOTORSPORT

59 PORTAL ST SUITE A

OTATI, CA 94931

07-664-8002

AR #ARD 101025

PA# CAL000064429

R/O # : 16131

Name : I

Date : 06/26/2015

License # : 1PCY741

Make : PORSCHE

Model : CARRERA

Year : 86

Odometer : 251493

Save Parts : NO

VIN : WPOAB0916GS120538

CA

ome: 22

ork: 5

ther:

LABOR

AMOUNT

Car towed in.

72.00

Check out non start (customer used starter fluid when car broke down and the engine would run)

Current test at the fuel pump showed a signal.

O&R fuel pump.

PARTS All parts new unless stated used or remanufactured

44 608 102 04

FUEL PUMP

PRICE

QTY

AMOUNT

328.79

1

328.79

SUBLET

ow

AMOUNT

72.50

Original Estimate : 503.70

Date	Increases to Estimate					Increase
	Time	OK'd By	Phone	Emp.		

Parts & labor conditionally guaranteed 4,000 mi./ 90 days.

LABOR	72.00
PARTS	328.79
SUBLET	72.50
	.00
SUB TOTAL	473.29
TAX	30.41
TOTAL	<u>503.70</u>

I hereby authorize DEJUNG MOTORSPORT to perform the repair work listed above along with necessary materials. You and your employees may operate the above vehicle for purposes of testing, inspection, or delivery at my risk. An express mechanics lien is acknowledged on above vehicle to secure the amount of repairs. Thereto it is understood that this company assumes no responsibility for loss or damage by theft or fire to vehicles placed with them for storage, sale, repair, or while road testing.

Authorized by : _____ Date : _____

Towing

Control # 498449

AAA # CA 0139074
 P.O. Box 7254 • Santa Rosa, CA 95407
 (707) 584-5000 or (800) 286-5002

SL

Bill To De Jung Motor Sports Called By
 Customer Address 459 Portal St.
 City Cotati State CA Zip Phone

VO # or Policy # Agent or Adjuster

0-8 1053 Make / Model / Yr / Color 86 Porsche 911 Blue Driver TD
 7 1112 Lic # 1PCY741 Odom: Keys Trk #
 9 1431 VIN

Owned From or Serviced At US-101 N / Petaluma Blvd N

Owned To 459 Portal St., Cotati \$

Id Tow \$ 60.⁰⁰

Rate Miles 6.5 N/C Miles 5.0 Net Miles 1.5 @ \$ 5.⁰⁰ \$ 7.⁵⁰

<input type="checkbox"/> LOCKOUT	<input checked="" type="checkbox"/> FLATBED	<input checked="" type="checkbox"/> FRONT TOW	DOLLIES	\$
<input type="checkbox"/> JUMP START	<input type="checkbox"/> WHEEL LIFT	<input type="checkbox"/> REAR TOW	DRIVELINE	\$
<input type="checkbox"/> FUEL DELIVERY	<input type="checkbox"/> SLING	<input type="checkbox"/> DOLLY	BRIDGE TOLL	\$
<input type="checkbox"/> TIRE SERVICE	<input type="checkbox"/> FRAME FORK	<input type="checkbox"/> DRIVELINE	FUEL	\$
<input type="checkbox"/> CLEAN UP	<input type="checkbox"/> TRAILER	<input type="checkbox"/> WINCHING	WINCHING	\$
<input type="checkbox"/> FB BASKET STRAPS	<input checked="" type="checkbox"/> STRAPS THRU WHEEL <u>x4</u>	ADD'L SERVICE		\$
<input type="checkbox"/> EXTRA LABOR - DESCRIBE				

Lease Auth By: <u> </u>	ADVANCED CHARGES	\$
Comments: <u> </u>	ADV. CHGS. FEE	\$
Comments: <u> </u>	LIEN FEE	\$

Side / Outside @ (\$ per calendar day) from to \$

(last 4) CASH CHARGE CHECK #

List Total \$ 77.⁵⁰
 Total \$ 77.⁵⁰

I, undersigned, do hereby certify that I am legally authorized and entitled to take possession of the above described vehicle and the personal property therein. I have received the vehicle in satisfactory condition.

BALANCE CARRIED OVER 30 DAYS WILL BE SUBJECT TO A LATE CHARGE OF 1.5% PER MONTH.

Upon request, you are entitled to receive a copy of the Towing Fees and Access Notice

REORDER FROM
 CTTA PRINTING CO-OP
 800.583.3515
 187-100 (12-14)

DE JUNG MOTORSPORT

59 PORTAL ST SUITE A

MOTATI, CA 94931

07-664-8002

VAR #ARD 101025

PA# CAL000064429

R/O # : 16119

Name _____

Date : 06/17/2015

License # : 1PCY741

Make : PORSCHE

Model : CARRERA

Year : 86

Odometer : 251310

Save Parts : NO

VIN : WPOAB0916GS120538

CA

Home:

Work:

Other:

LABOR

AMOUNT

Check out non start of engine (engine has not died while running).

36.00

This did not show up at the shop.

Remove DME relay. Open and inspect relay. The contact points are showing color and carbon build up.

Replace the DME relay.

Inspect steering wheel.

.00

Tighten hub extension bolts.

PARTS All parts new unless stated used or remanufactured

11 618 154 00

RELAY, IGNITION/FUEL

PRICE

QTY

AMOUNT

54.34

1

54.34

Original Estimate : 95.37

Date	Increases to Estimate				
	Time	OK'd By	Phone	Emp.	Increase

Parts & labor conditionally guaranteed 4,000 mi./ 90 days.

LABOR	36.00
PARTS	54.34
SUBLETS	.00
	.00
SUB TOTAL	90.34
TAX	5.03
TOTAL	<u>95.37</u>

By authorizing this repair order, you authorize DEJUNG MOTORSPORT to perform the repair work listed above along with necessary materials. You and your employees may operate the above vehicle for the purposes of testing, inspection, or delivery at my risk. An express mechanics lien is acknowledged on above vehicle to secure the amount of repairs. Thereto it is understood that this company assumes no responsibility for loss or damage by theft or fire to vehicles placed with them for storage, sale, repair, or while road testing.

Authorized by : _____ Date : _____

DEJUNG MOTORSPORT

59 PORTAL ST SUITE A

MOTATI, CA 94931

07-664-8002

WAR #ARD 101025

PA# CAL000064429

R/O # : 16074

Name :

Date : 05/07/2015

License # : 1PCY741

Make : PORSCHE

Model : CARRERA

Year : 86

Odometer : 250617

Save Parts : NO

VIN : WPOAB0916GS120538

CA

Home:

Work:

Other:

LABOR

AMOUNT

Oil & R oil pressure sender.

156.00

Flush hydraulic system.

96.00

ARTS All parts new unless stated used or remanufactured

11 606 135 00

OIL PRESSURE SENSOR

PRICE

QTY

AMOUNT

108.65

1

108.65

AB

BRAKE FLUID P/LITER

18.58

1

18.58

Original Estimate : 391.00

Date	Increases to Estimate					Increase
	Time	OK'd By	Phone	Emp.		

Parts & labor conditionally guaranteed 4,000 mi./ 90 days.

LABOR	252.00
PARTS	127.23
SUBLETS	.00
	.00
SUB TOTAL	379.23
TAX	11.77
TOTAL	391.00

By authorizing DEJUNG MOTORSPORT to perform the repair work listed above along with necessary materials. You and your employees may operate the above vehicle for purposes of testing, inspection, or delivery at my risk. An express mechanics lien is acknowledged on above vehicle to secure the amount of repairs. Thereto it is understood that this company assumes no responsibility for loss or damage by theft or fire to vehicles placed with them for storage, sale, repair, or while road testing.

Authorized by : _____ Date : _____

JE JUNG MOTORSPORT

59 PORTAL ST SUITE A

MOTATI, CA 94931

07-664-8002

AR #ARD 101025

PA# CAL000064429

R/O # : 16066

Name :

Date : 05/01/2015

License # : 1PCY741

Make : PORSCHE

Model : CARRERA

Year : 86

Odometer : 250198

Save Parts : NO

VIN : WPOAB0916GS120538

CA

ome:

ork:

ther:

ABOR**AMOUNT**

Major service:

Tune up

Adjust valves

Full service

720.00

Check for erratic reading oil pressure gauge.

The oil pressure switch is leaking, part is on order.

.00

ARTS		PRICE	QTY	AMOUNT
DC 54	All parts new unless stated used or remanufactured OIL FILTER	20.34	1	20.34
30 110 393 00	AIR FILTER	23.66	1	23.66
28 110 253 06	FUEL FILTER	38.58	1	38.58
PK 03	V/C GASKET KIT	69.70	1	69.70
30 602 919 00	CAP	117.18	1	117.18
30 602 902 01	ROTOR	25.49	1	25.49
99 170 165 90	SPARK PLUG	19.42	6	116.52
5	**CASTROL OIL(PTS.)	3.00	22	66.00
1	TECHRON	9.00	1	9.00

DE JUNG MOTORSPORT

59 PORTAL ST SUITE A

MOTATI, CA 94931

07-664-8002

BAR #ARD 101025

PA# CAL000064429

R/O # : 16066

Page : 2

Name

Date : 05/01/2015

License # : 1PCY741

Make : PORSCHE

Model : CARRERA

Year : 86

Odometer : 250198

Save Parts : NO

VIN : WPOAB0916GS120538

CA

Home:

Work:

Other:

ARTS	All parts new unless stated used or remanufactured	PRICE	QTY	AMOUNT
B3	WASHER SOLVENT	3.50	1	3.50
1602227	COPPER WASHER	.90	2	1.80
1157	BULB	1.94	1	1.94

Original Estimate : 1,267.58

Date	Increases to Estimate					Increase
	Time	OK'd By	Phone	Emp.		

LABOR	720.00
PARTS	493.71
SUBLETS	.00
	.00
HAZARDOUS MATERIALS	8.20
SUB TOTAL	1,221.91
TAX	45.67
TOTAL	1,267.58

Parts & labor conditionally guaranteed 4,000 mi./ 90 days.

I hereby authorize DEJUNG MOTORSPORT to perform the repair work listed above along with necessary materials. You and your employees may operate the above vehicle for purposes of testing, inspection, or delivery at my risk. An express mechanics lien is acknowledged on above vehicle to secure the amount of repairs. Thereto it is understood that this company assumes no responsibility for loss or damage by theft or fire to vehicles placed with them for storage, sale, repair, or while road testing.

Authorized by : _____ Date : _____

Vehicle Information

Test Date/Time: 12/22/2014 @ 05:33 PM

Model-Year: 1986	Make: PORSCHE	Model: 911 CARRERA
License: 1PCY741	State: California	VIN: WP0AB0916GS120538
Engine Size: 3.20 L	Type: Passenger	Transmission: Manual
3VWR: 0	Test Weight: 3000	Cylinders: 6
Odometer: 248043	Certification: California	VLT Record #: 18708
Fuel Type: Gasoline	Exhaust: Single	Inspection Reason: High Emitter Profile (HEP)
		Engine Year: 0000

Overall Test Results

Congratulations! Your vehicle passed the enhanced Smog Check inspection, which helps California reach its daily goal of removing an extra 100 tons of smog-forming emissions from the air. Thank you for keeping your vehicle well maintained.

Comprehensive Visual Inspection: **PASS** Functional Check: **PASS** Emissions Test: **PASS**

Smog Check Certificate Number: **PM961757C**

DMV ID Number: **3146M353P088**

Your Smog Check certificate will be electronically transmitted to DMV
Please keep this copy for your records

Emission Control Systems Visual Inspection/Functional Check Results

(Visual/Functional tests are used to assist in the identification of oxides of nitrogen, crankcase and cold start emission which are not measured during the ASM tests.)

<u>RESULT</u>	<u>ECS</u>	<u>RESULT</u>	<u>ECS</u>	<u>RESULT</u>	<u>ECS</u>
PASS-	PCV	N/A-	Thermostatic Air Cleaner	PASS-	Fuel Evaporative Controls
PASS-	Catalytic Converter	N/A-	Air Injection System	PASS-	Fuel Tank Cap Visual
N/A-	Visual EGR	PASS-	Ignition Spark Controls	N/A-	Carburetor
PASS-	Fuel Injection	PASS-	O2 Sensors and Connectors	PASS-	Wiring of Other
PASS-	Vacuum Line Connections	PASS-	Other Emission Related		Sensors or Switches
N/A-	MIL	N/A-	Functional EGR	N/A-	Ignition Timing: TDC
N/A-	Fuel Evap Test	N/A-	Fill Pipe Restrictor	PASS-	Liquid Fuel Leaks

ASM Emission Test Results

Test	RPM	CO2 (%)		HC (PPM)			CO(%)			NO (PPM)			Results
		MEAS	MEAS	MAX	AVE	MEAS	MAX	AVE	MEAS	MAX	AVE	MEAS	
15 mph	1483	14.90	0.10	138	29	6	0.85	0.20	0.00	804	314	0	PASS
25 mph	2397	14.80	0.01	113	25	5	0.65	0.14	0.01	685	275	0	PASS

MAX = Maximum Allowable Emissions

AVE = Average Emissions For Passing Vehicles

MEAS = Amount Measured

Smog Check Inspection Station Information

TEST ONLY SMOG OF ROHNERT PARK

485 SOUTHWEST BLVD

ROHNERT PARK 94928

07-792-9800

Station Number: TC248969

Technician Name/Number: GILBERT, BRIAN/EO151825

Repair Tech. Name/Number: N/A

Software Version/EIS Number: 1301/WP392348

I certify, under penalty of perjury under the laws of the State of California, that I inspected the vehicle described above, that I performed the inspection in accordance with all bureau requirements, and that the information listed on the vehicle inspection report is true and correct.

12/22/14

Date

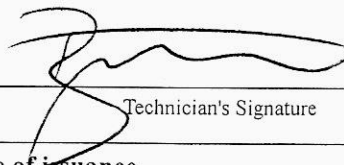

Technician's Signature

Certificates are valid for 90 days from date of issuance

Customer: _____ Owner/Driver: _____ Address: _____ <u>SEBASTOPOL, CA 95473</u> Phone: _____ Registration Due Date: _____ Email Address: _____	INVOICE # 034634 Date/Time In: 12/10/2014 11:26 AM Date/Time Out: 12/10/2014 12:10 PM Results: FAIL Certificate # _____ Service performed by BRYAN S. Manual Estimate # _____ PO # _____
---	---

License: 1PCY741 State: CA Year/Make/Model: 1986 PORSCHE 911

Odometer: 247916 Vehicle VIN Number: WP0AB0916GS120538

Reason For Service: _____

Quantity	Item #	Description	Unit Price	Discount	Extended Price
1	01-TEST	Smog Inspection	79.75	\$20.00	59.75
0	06-CERT	Smog Certificate	8.25		0.00

Notes:

Subtotal Parts:	\$0.00
Sales Tax:	0.00
State Certificate:	0.00
Subtotal Labor:	<u>59.75</u>
TOTAL PRICE:	\$59.75
PAID BY: VISA	\$59.75

Notice: You may choose another Smog Check Station to perform the needed repairs, installations, adjustments, or subsequent tests.

Change: No Change
Approval Code:

I acknowledge receipt of the above services and/or products:

Authorized by (customer signature): _____

Thanks for your business.



Vehicle Information

Test Date/Time: 12/10/2014 @ 11:44 AM

Model-Year: 1986	Make: PORSCHE	Model: 911 CARRERA
License: 1PCY741	State: California	VIN: WP0AB0916GS120538
Engine Size: 3.20 L	Type: Passenger	Transmission: Manual
IVWR: 0	Test Weight: 3000	Cylinders: 6
Odometer: 247916	Certification: California	VLT Record #: 18708
Fuel Type: Gasoline	Exhaust: Single	Inspection Reason: High Emitter Profile (HEP)
		Engine Year: 0000

Overall Test Results

Repairing your vehicle is necessary to help California reduce smog-forming emissions and reach our air quality goals.

Comprehensive Visual Inspection: **PASS**

Functional Check: **PASS**

Emissions Test: **FAIL**

Emission Control Systems Visual Inspection/Functional Check Results

(Visual/Functional tests are used to assist in the identification of oxides of nitrogen, crankcase and cold start emission which are not measured during the ASM tests.)

<u>RESULT</u>	<u>ECS</u>	<u>RESULT</u>	<u>ECS</u>	<u>RESULT</u>	<u>ECS</u>
ASS-	PCV	N/A-	Thermostatic Air Cleaner	PASS-	Fuel Evaporative Controls
ASS-	Catalytic Converter	N/A-	Air Injection System	PASS-	Fuel Tank Cap Visual
I/A-	Visual EGR	PASS-	Ignition Spark Controls	N/A-	Carburetor
ASS-	Fuel Injection	PASS-	O2 Sensors and Connectors	PASS-	Wiring of Other
ASS-	Vacuum Line Connections	PASS-	Other Emission Related		Sensors or Switches
ASS-	Fuel Cap Functional	N/A-	Functional EGR	N/A-	Ignition Timing: TDC
I/A-	MIL	N/A-	Fill Pipe Restrictor	PASS-	Liquid Fuel Leaks
I/A-	Fuel Evap Test				

ASM Emission Test Results

Test	RPM	CO2 (%)		HC (PPM)			CO(%)			NO (PPM)			Results
		MEAS	MEAS	MAX	AVE	MEAS	MAX	AVE	MEAS	MAX	AVE	MEAS	
15 mph	1484	14.49	0.26	138	29	46	0.85	0.20	0.09	804	314	1252	FAIL
25 mph	2383	14.30	0.47	113	25	47	0.65	0.14	0.11	685	275	1019	FAIL

MAX = Maximum Allowable Emissions

AVE = Average Emissions For Passing Vehicles

MEAS = Amount Measured

Failed smog check? Financial assistance may be available. To get an application, visit the Bureau of Automotive Repair's website at www.smogcheck.ca.gov or call toll-free at 800.952.5210. Si usted ha fallado el examen de smog, asistencia financiera puede estar disponible. Para obtener una solicitud, visite www.smogcheck.ca.gov o llamenos a BAR al 800.952.5210.

Smog Check Inspection Station Information

TEST ONLY SMOG OF ROHNERT PARK

485 SOUTHWEST BLVD

ROHNERT PARK 94928

07-792-9800

Station Number: TC248969

Technician Name/Number: ARRIETA-CORTEZ, JUAN/EO635319

Repair Tech. Name/Number: N/A

Software Version/EIS Number: 1301/WP392348

I certify, under penalty of perjury under the laws of the State of California, that I inspected the vehicle described above, that I performed the inspection in accordance with all bureau requirements, and that the information listed on the vehicle inspection report is true and correct.

Date

Technician's Signature



A+ TEST ONLY SMOG TEST ONLY STATION COTATI
6811 Redwood Dr., Ste. B • Cotati, CA 94931

No 43230

Phone (707) 792-1512

SMOG TEST-ONLY INVOICE

BAR No. AB237679

NAME	TODAY'S DATE	YEAR	MAKE	MODEL
ADDRESS	12-16-14	2006	PONSCHE	911
CITY, STATE ZIP	SEBATO PODL	ODOMETER	LIC. PLATE #	MOTOR #
PHONE / CUSTOMER EMAIL		298029	1PCY 741	
METHOD OF PAYMENT: <input type="checkbox"/> CASH <input type="checkbox"/> CHECK <input type="checkbox"/> CHARGE <input type="checkbox"/> DEBIT CARD <input type="checkbox"/> CREDIT CARD	ORIGINAL ESTIMATE	TEST TYPE: <input checked="" type="checkbox"/> BIENNIAL <input type="checkbox"/> CHANGE OF OWNERSHIP <input type="checkbox"/> 2% <input type="checkbox"/> HEP <input type="checkbox"/> INITIAL	TRANSMISSION: <input type="checkbox"/> AUTO <input checked="" type="checkbox"/> STD	ENGINE 3.2 # OF CYLINDERS 6
	\$ 18.25	<input checked="" type="checkbox"/> CALIF. <input type="checkbox"/> O/S	TIMING NA	EM. LIGHT P

SMOG TEST CHECK OFF

P-Pass M-Modified F-Defective D-Disconnected S-Missing N-N/A

PCV	P	C/O	P
TAC	P	AP/P	P
EVP	P	OXY	P
CAT	P	WRG	P
EGR	P	VAC	P
SPK	P	OTH	P

OPR.	DESCRIPTION OF WORK	AMOUNT
	SMOG TEST	25 25
	PRETEST <input type="checkbox"/> YES <input type="checkbox"/> NO	
	CERTIFICATE #	8 25
	ELECTRONIC TRANSFER FEE (E.T.F.)	
	RETEST 10 th + CRV	10
	GAS CAP	
	LOW PRESSURE FUEL EVAP TEST (LPFET)	
	SHOP DISC	30

TIRE PRESSURE INSPECTION

Performed LF: RF: LR: RR: (psi)

Inspection Declined, Reason: Initials:

ASM | Failed Rep. Disc. ref.

TEST RESULTS: PASS FAIL ABORT

THIS SMOG TEST-ONLY STATION CANNOT PERFORM ANY DIAGNOSTICS, ADJUSTMENTS OR REPAIRS

I hereby authorize the above smog test to be performed. Smog test fee is due whether above vehicle passes or fails the smog test. You and your employees may operate above vehicle for purposes of testing, inspection and delivery at my risk. An express mechanic's lien is acknowledged on above vehicle to secure the amount of this invoice. You will not be held responsible for loss or damage to vehicle due to fire, theft, accident, dynamometer testing or any other cause beyond your control. In the event legal action is necessary to enforce this contract, I understand that I am solely responsible for all costs including attorney's fees and court costs. I have read and understand the above and acknowledge receipt of an estimate. SMOG CHECK CUSTOMERS: BY LAW YOU MAY CHOOSE ANOTHER SMOG CHECK STATION TO PERFORM ANY REPAIRS, INSTALLATIONS, ADJUSTMENTS OR SUBSEQUENT TESTS.

X _____ DATE: _____

REVISOR: _____ TIME: _____ PHONE/FAX/EMAIL: _____

ESTIMATE \$ _____ PHONE EMAIL IN PERSON FAX

REASON: _____ ADDITIONAL COST \$ _____

I acknowledge notice and oral approval of an increase in the original estimated price. **X**

TOTAL WORK	
CERTIFICATE	
E.T.F.	
SUB TOTAL	9
SALES TAX	
GRAND TOTAL	10

Vehicle Information

Test Date/Time: 12/16/2014 @ 02:05 PM

Model-Year: 1986	Make: PORSCHE	Model: 911 CARRERA
License: 1PCY741	State: California	VIN: WP0AB0916GS120538
Engine Size: 3.20 L	Type: Passenger	Transmission: Manual
IVWR: 0	Test Weight: 3000	Cylinders: 6
Odometer: 248029	Certification: California	VLT Record #: 18708
Fuel Type: Gasoline	Exhaust: Single	Inspection Reason: High Emitter Profile (HEP)
		Engine Year: 0000

Overall Test Results

Repairing your vehicle is necessary to help California reduce smog-forming emissions and reach our air quality goals.

Comprehensive Visual Inspection: **PASS**

Functional Check: **PASS**

Emissions Test: **FAIL**

Emission Control Systems Visual Inspection/Functional Check Results

(Visual/Functional tests are used to assist in the identification of oxides of nitrogen, crankcase and cold start emission which are not measured during the ASM tests.)

<u>RESULT</u>	<u>ECS</u>	<u>RESULT</u>	<u>ECS</u>	<u>RESULT</u>	<u>ECS</u>
ASS-	PCV	N/A-	Thermostatic Air Cleaner	PASS-	Fuel Evaporative Controls
ASS-	Catalytic Converter	N/A-	Air Injection System	PASS-	Fuel Tank Cap Visual
I/A-	Visual EGR	PASS-	Ignition Spark Controls	N/A-	Carburetor
ASS-	Fuel Injection	PASS-	O2 Sensors and Connectors	PASS-	Wiring of Other
ASS-	Vacuum Line Connections	PASS-	Other Emission Related		Sensors or Switches
		N/A-	Functional EGR	N/A-	Ignition Timing: TDC
I/A-	MIL	N/A-	Fill Pipe Restrictor	PASS-	Liquid Fuel Leaks
I/A-	Fuel Evap Test				

ASM Emission Test Results

Test	RPM	CO2	O2	HC (PPM)			CO(%)			NO (PPM)			Results
		(%)	(%)	MAX	AVE	MEAS	MAX	AVE	MEAS	MAX	AVE	MEAS	
15 mph	1522	14.25	0.62	138	29	5	0.85	0.20	0.00	804	314	1234	FAIL
25 mph	2354	14.54	0.24	113	25	4	0.65	0.14	0.00	685	275	889	FAIL

MAX = Maximum Allowable Emissions

AVE = Average Emissions For Passing Vehicles

MEAS = Amount Measured

Failed smog check? Financial assistance may be available. To get an application, visit the Bureau of Automotive Repair's website at www.smogcheck.ca.gov or call toll-free at 800.952.5210. Si usted ha fallado el examen de smog, asistencia financiera puede estar disponible. Para obtener una solicitud, visite www.smogcheck.ca.gov o llamenos a BAR al 800.952.5210.

Smog Check Inspection Station Information

+ TEST ONLY SMOG OF ROHNERT PARK

485 SOUTHWEST BLVD

ROHNERT PARK 94928

707-792-9800

Station Number: TC248969

Technician Name/Number: ARRIETA-CORTEZ, JUAN/EO635319

Repair Tech. Name/Number: N/A

Software Version/EIS Number: 1301/WP392348

I certify, under penalty of perjury under the laws of the State of California, that I inspected the vehicle described above, that I performed the inspection in accordance with all bureau requirements, and that the information listed on the vehicle inspection report is true and correct.

12/16/14

Date

[Signature]

Technician's Signature

Customer: _____	ESTIMATE # 034634
Owner/Driver: _____	
Address: _____	
SEBASTOPOL, CA 95473	
Phone: _____	
Email Address: _____	Manual Est # _____ PO # _____
	Date/Time In: 12/10/2014 11:26 AM
	Registration Due Date: _____

License: 1PCY741 State: CA Year/Make/Model: 1986 PORSCHE 911

Odometer: 247916 Vehicle VIN Number: WP0AB0916GS120538

Reason For Service: _____

Quantity	Item #	Description	Unit Price	Discount	Extended Price
1	01-TEST	Smog Inspection	79.75	\$20.00	59.75
1	06-CERT	Smog Certificate	8.25		8.25

Notes:

Subtotal Parts:	\$0.00
Sales Tax:	\$0.00
State Certificate:	\$8.25
Subtotal Labor:	\$59.75
TOTAL ESTIMATED PRICE:	\$68.00

Notice: You may choose another Smog Check Station to perform needed repairs, installations, adjustments, or subsequent tests.

- Tire pressure check waived because The tire pressure on my vehicle was checked within the last 30 days _____ (please initial)
- I authorize A + TEST ONLY SMOG OF ROHNERT PARK to perform the indicated services. With respect to such services, I agree as follows:
- 1- I am responsible for removing all valuable property from my vehicle prior to service, as A + TEST ONLY SMOG OF ROHNERT PARK shall NOT be held liable for any lost or stolen property.
 - 2- The services which will be performed require that A + TEST ONLY SMOG OF ROHNERT PARK personnel take certain actions such as adjusting seats and windows, applying the emergency brake, opening and closing the engine cover, starting and driving the vehicle, and I hereby ASSUME ALL RISKS relating to such activity, including damage to my vehicle unless the person(s) operating the vehicle have done so with gross negligence or willful misconduct.
 - 3- I am responsible for informing A + TEST ONLY SMOG OF ROHNERT PARK prior to the performance of services of any pre-existing conditions or faults pertinent to aforementioned vehicle which may result in damage during the performance of the test.
 - 4- I shall inspect my vehicle on the premises after the services have been rendered, and any problems or issues that would be apparent as a result of such inspection shall be waived by me if not reported prior to leaving the premises.
 - 5- Under no circumstances shall A + TEST ONLY SMOG OF ROHNERT PARK be liable for collateral, consequential, indirect or incidental damages arising out of or connected in any way with the services provided.

Authorized by (customer signature) _____



DE JUNG MOTORSPORT

59 PORTAL ST SUITE A

MOTATI, CA 94931

07-664-8002

MAR #ARD 101025

PA# CAL000064429

R/O # : 15900

Name

Date : 12/12/2014

License # : 1PCY741

Make : PORSCHE

Model : CARRERA

Year : 86

Odometer : 248023

Save Parts : NO

VIN : WPOAB0916GS120538

CA

Home: 22

Work:

Other:

ABOR**AMOUNT**

R&R catalytic converter.
Send out for inspection.
Failed inspection.

210.00

Perform intake/combustion chamber clean out.
Drive car to complete clean out procedure.
R&R oxygen sensor (because of low CO and HC readings).
Send out for inspection.
Passed inspection.

Check out heater cables:
Right cable is broken.
Left cable is stiff because of old grease.
R&R both heater cables.

300.00

PARTS		PRICE	QTY	AMOUNT
58863	All parts new unless stated used or remanufactured CATALYTIC CONVERTER	400.00	1	400.00
11 559 149 01	PLUG-ROCKER TRIM	5.11	1	5.11
11 424 701 01	HEATER CABLE WIRE	29.53	2	59.06
SEASS14	INTAKE/COMBUSTION CHAMBER CLEANER	13.99	1	13.99
65 606 126 01	OXYGEN SENSOR	184.07	1	184.07

UBLETS

inspection

AMOUNT

18.00

DE JUNG MOTORSPORT

59 PORTAL ST SUITE A

COTATI, CA 94931

'07-664-8002

BAR #ARD 101025

PA# CAL000064429

R/O # : **15900**

Page : 2

Name : _____

Date : 12/12/2014

License # : 1PCY741

Make : PORSCHE

Model : CARRERA

Year : 86

Odometer : 248023

Save Parts : NO

VIN : WPOAB0916GS120538

CA

Home

Work:

Other:

Original Estimate : 1,251.49

Increases to Estimate					
Date	Time	OK'd By	Phone	Emp.	Increase

Parts & labor conditionally guaranteed 4,000 mi./ 90 days.

I hereby authorize DEJUNG MOTORSPORT to perform the repair work listed above along with necessary materials. You and your employees may operate the above vehicle for purposes of testing, inspection, or delivery at my risk. An express mechanics lien is acknowledged on above vehicle to secure the amount of repairs. Thereto it is understood that this company assumes no responsibility for loss or damage by theft or fire to vehicles placed with them for storage, sale, repair, or while road testing.

LABOR	510.00
PARTS	662.23
SUBLETS	18.00
	.00
SUB TOTAL	1,190.23
TAX	61.26
TOTAL	<u>1,251.49</u>

Authorized by : _____ Date : _____

DE JUNG MOTORSPORT
 59 PORTAL ST SUITE A
 POTATI, CA 94931
 07-664-8002
 CAR #ARD 101025
 PA# CAL000064429

R/O # : **15542**
 Name _____
 Date : 03/06/2014
 License # : 1PCY741
 Make : PORSCHE
 Model : CARRERA
 Year : 86
 Odometer : 243045 Save Parts : NO
 VIN : WPOAB0916GS120538

CA _____
 Home: _____
 Work: _____
 Other: _____

ABOR

	AMOUNT
Check seat heater. L&I drivers seat. With by-passing the seat controller, heat was coming from the backrest but not the seat bottom (light 80') Will need the wiring diagram to test further.	.00
Check for sun roof leak. Blow out the "A" pillar and "C" pillar vents	.00
3 hours 35 minutes spent on above time	120.00

Original Estimate : .00

Date	Increases to Estimate					Increase
	Time	OK'd By	Phone	Emp.		

LABOR	120.00
PARTS	.00
SUBLETS	.00
	.00
SUB TOTAL	120.00
TAX	.00
TOTAL	<u>120.00</u>

Parts & labor conditionally guaranteed 4,000 mi./ 90 days.

By authorizing DEJUNG MOTORSPORT to perform the repair work listed above along with necessary materials. You and your employees may operate the above vehicle for purposes of testing, inspection, or delivery at my risk. An express mechanics lien is acknowledged on above vehicle to secure the amount of repairs. Thereto it is understood that this company assumes no responsibility for loss or damage by theft or fire to vehicles placed with them for storage, sale, repair, or while road testing.

Authorized by : _____ Date : _____

DE JUNG MOTORSPORT

59 PORTAL ST SUITE A

OTATI, CA 94931

07-664-8002

AR #ARD 101025

PA# CAL000064429

R/O # : 15697

Name

Date : 07/01/2014

License # : 1PCY741

Make : PORSCHE

Model : CARRERA

Year : 86

Odometer : 244689

Save Parts : NO

VIN : WPOAB0916GS120538

CA

ome:

ork: 5

ther:

ABOR

AMOUNT

Change engine oil and filter.

Check transaxle oil level.

Inspect brakes.

Check tire pressures.

Check lights.

Check brake fluid level.

120.00

L&R drivers window switch

.00

Check out AC system:

Compressor does turn on

Hook up pressure gauges

Low side reading 0

Hight side reading 0

156.00

Evacuate AC system to see if the system holds.

After 0 hours 50 minutes the vacuum was still holding.

Charge AC system.

Test temps 47'

ARTS All parts new unless stated used or remanufactured

		PRICE	QTY	AMOUNT
IC 54	OIL FILTER	20.34	1	20.34
5	**CASTROL OIL(PTS.)	3.00	22	66.00
602227	COPPER WASHER	.90	2	1.80

DE JUNG MOTORSPORT

59 PORTAL ST SUITE A

MOTATI, CA 94931

07-664-8002

AR #ARD 101025

PA# CAL000064429

DAMON BROWN

CA

Home

Work:

Other:

R/O # : 15697

Page : 2

Name :

Date : 07/01/2014

License # : 1PCY741

Make : PORSCHE

Model : CARRERA

Year : 86

Odometer : 244689

Save Parts : NO

VIN : WPOAB0916GS120538

01	TECHRON	9.00	1	9.00
03	WASHER SOLVENT	3.50	1	3.50
0-12	FREON P/OZ	3.50	36.5	127.75
011 613 621 03	WINDOW SWITCH	37.33	1	37.33

Original Estimate : 542.09

Increases to Estimate					
Date	Time	OK'd By	Phone	Emp.	Increase

LABOR	276.00
PARTS	265.72
SUBLETS	.00
HAZARDOUS MATERIALS	.00
SUB TOTAL	8.20
TAX	549.92
TOTAL	23.25
TOTAL	<u>573.17</u>

Parts & labor conditionally guaranteed 4,000 mi./90 days.

I hereby authorize DEJUNG MOTORSPORT to perform the repair work listed above along with necessary materials. You and your employees may operate the above vehicle for purposes of testing, inspection, or delivery at my risk. An express mechanics lien is acknowledged on above vehicle to secure the amount of repairs. Thereto it is understood that this company assumes no responsibility for loss or damage by theft or fire to vehicles placed with them for storage, sale, repair, or while road testing.

Authorized by : _____ Date : _____

REPAIR ORDER

DE JUNG MOTORSPORT

459 PORTAL ST SUITE A

COTATI, CA 94931

707-664-8002

BAR #ARD 101025

EPA# CAL000064429

R/O # : 15425

Name :

Date : 12/10/2013

License # : 1PCY741

Make : PORSCHE

Model : CARRERA

Year : 86

Odometer : 241729

Save Parts : NO

VIN : WPOAB0916GS120538

, CA

Home:

Work: 1 1

Other:

LABOR

AMOUNT

Customer had a knocking noise, increased with engine RPM, coming from the left timing chain/tensioner area.

240.00

Remove parts as necessary to access the chain covers.

Remove chain covers to inspect chain tensioners and timing chains.

Found the left timing chain had slack on the drive side (1/2" lift, off the chain ramp).
12/9/2013 - 2 hours 0 minutes

R&I the ignition distributor. Clean and lube distributor.

690.00

R&R the chain tensioners, cam oil lines, tensioner oil lines.

Install tensioner oil line, supports.

Install the chain covers.

Install parts removed to access the chain covers.

R&R oil pressure sending unit. Repair wiring at the oil pressure sending unit.

PARTS All parts new unless stated used or remanufactured

		PRICE	QTY	AMOUNT
930 105 058 03	TIMING CHAIN TENSIONER	415.23	2	830.46
999 701 690 40	TENSIONER "O" RING	4.20	2	8.40
900 123 115 30	CRUSH WASHER	.85	4	3.40
930 105 191 03	GASKET-CHAIN COVER	12.18	1	12.18
930 105 192 04	GASKET-CHAIN COVER	12.18	1	12.18
930 107 341 00	OIL LINE BRACKET	5.16	1	5.16

REPAIR ORDER

DE JUNG MOTORSPORT
 459 PORTAL ST SUITE A
 COTATI, CA 94931
 707-664-8002
 BAR #ARD 101025
 EPA# CAL000064429

R/O # : 15425

Page : 2

Name : _____

Date : 12/10/2013

License # : 1PCY741

Make : PORSCHE

Model : CARRERA

Year : 86

Odometer : 241729

Save Parts : NO

VIN : WPOAB0916GS120538

√

, CA

Home:

Work:

Other:

Part #	Description	Unit Price	Quantity	Total Price
930 107 342 01	OIL LINE BRACKET	5.16	1	5.16
900 119 059 02	OIL LINE CLAMP SCREW	1.69	2	3.38
999 511 174 02	OIL LINE CLAMP	4.20	2	8.40
930 107 347 02	OIL FEED LINE	38.25	1	38.25
930 107 348 09	OIL FEED LINE	47.52	1	47.52
930 107 347 12	OIL LINE	69.29	1	69.29
930 107 348 12	OIL LINE	69.29	1	69.29
36806	6MM NYLOX NUT	.30	19	5.70
463610	6MM ALUMINUM WASHER	.14	19	2.66
36808	8MM NYLOX NUT	.36	2	.72
273 158515	8MM ALUMINUM WASHER	.35	2	.70
4601216	COPPER WASHER	.33	6	1.98
911 606 135 00	OIL PRESSURE SENDER	74.13	1	74.13
15	**CASTROL OIL(PTS.)	3.00	2	6.00

Original Estimate : .00

Increases to Estimate					
Date	Time	OK'd By	Phone	Emp.	Increase
12/10/2013	4:30pm	DAMON	544-0784	SD	1,101.27

LABOR	930.00
PARTS	1,204.96
SUBLETS	.00
	.00
HAZARDOUS MATERIALS	0.60
SUB TOTAL	2,135.56
TAX	105.43
TOTAL	2,240.99

Parts & labor conditionally guaranteed 4,000 mi./ 90 days.

I hereby authorize DEJUNG MOTORSPORT to perform the repair work listed above along with necessary materials. You and your employees may operate the above vehicle for purposes of testing, inspection, or delivery at my risk. An express mechanics lien is acknowledged on above vehicle to secure the amount of repairs. Thereto it is understood that this company assumes no responsibility for loss or damage by theft or fire to vehicles placed with them for storage, sale, repair, or while road testing.

Authorized by : _____ Date : _____

REPAIR ORDER

DE JUNG MOTORSPORT
 459 PORTAL ST SUITE A
 COTATI, CA 94931
 707-664-8002
 BAR #ARD 101025
 EPA# CAL000064429

R/O # : 15291
 Name :
 Date : 08/19/2013
 License # : 1PCY741
 Make : PORSCHE
 Model : CARRERA
 Year : 86
 Odometer : 240538 Save Parts : NO
 VIN : WPOAB0916GS120538

L. _____

 CA _____
 Home: _____
 Work: 5 _____
 Other: _____

LABOR	AMOUNT
Change engine oil and filter.	120.00
Check transaxle oil level.	
Inspect brakes.	
Check tire pressures.	
Check lights.	
Check brake fluid level.	

PARTS	All parts new unless stated used or remanufactured	PRICE	QTY	AMOUNT
OC 54	OIL FILTER	19.86	1	19.86
15	**CASTROL OIL(PTS.)	3.00	22	66.00
4602227	COPPER WASHER	.94	2	1.88
01	TECHRON	9.00	1	9.00

Original Estimate : 233.40

Increases to Estimate					
Date	Time	OK'd By	Phone	Emp.	Increase

LABOR	120.00
PARTS	96.74
SUBLETS	.00
HAZARDOUS MATERIALS	8.20
SUB TOTAL	224.94
TAX	8.46
TOTAL	<u>233.40</u>

Parts & labor conditionally guaranteed 4,000 mi./ 90 days.

I hereby authorize DEJUNG MOTORSPORT to perform the repair work listed above along with necessary materials. You and your employees may operate the above vehicle for purposes of testing, inspection, or delivery at my risk. An express mechanics lien is acknowledged on above vehicle to secure the amount of repairs. Thereto it is understood that this company assumes no responsibility for loss or damage by theft or fire to vehicles placed with them for storage, sale, repair, or while road testing.

Authorized by : _____ Date : _____

A+ TEST ONLY

A+ TEST ONLY

SMOG TEST-ONLY SERVICE OF COTATI

No 34801

SMOG

6811 Redwood Dr., Ste. B • Cotati, CA 94931

Phone (707) 792-1512

BAR No. AB237679

#1863

SMOG TEST-ONLY INVOICE

PAID check 1863

NAME: Steve DeJures
 TODAY'S DATE: 12-19-12
 YEAR: 1986
 MAKE: Renault
 MODEL: CARVERA
 ADDRESS: [blank]
 ODOMETER: 235179
 LIC. PLATE #: 1PC7741
 MOTOR #: [blank]
 CITY, STATE ZIP: Del Norte Bank
 WRITTEN BY: [blank]
 CUSTOMER P.O. #: [blank]
 G.V.W.R.: [blank]
 PHONE / CUSTOMER EMAIL: ()

TEST TYPE: BIENNIAL CHANGE OF OWNERSHIP 2% HEP INITIAL
 FED. CALIF. O/S ENGINE 3.2 # OF CYLINDERS 6
 TRANSMISSION: AUTO STD TIMING 12F EM. LIGHT P

METHOD OF PAYMENT: CASH CHECK DEBIT CARD CREDIT CARD
 CHARGE ORIGINAL ESTIMATE \$ 58

SMOG TEST CHECK OFF

P-Pass	M-Modified	F-Defective	D-Disconnected	S-Missing	N-N/A
PCV	P		C/D		
TAC	P		AP/P		
EVP	P		OXY		
CAT	P		WRG		
EGR	P		VAC		
SPK	P		OTH		

OPR.	DESCRIPTION OF WORK	AMOUNT
	SMOG TEST	79 75
	PRETEST <input type="checkbox"/> YES <input type="checkbox"/> NO	
	CERTIFICATE #	8 25
	ELECTRONIC TRANSFER FEE (E.T.F.)	
	RETEST	
	GAS CAP	
	LOW PRESSURE FUEL EVAP TEST (LPFET)	
	couper - 30	

TIRE PRESSURE INSPECTION

Performed LF: RF: LR: RR: (psi)
 Inspection Declined, Reason: Initials:

ADM / PAS

TEST RESULTS: PASS FAIL ABORT

THIS SMOG TEST-ONLY STATION CANNOT PERFORM ANY DIAGNOSTICS, ADJUSTMENTS OR REPAIRS

I hereby authorize the above smog test to be performed. Smog test fee is due whether above vehicle passes or fails the smog test. You and your employees may operate above vehicle for purposes of testing, inspection and delivery at my risk. An express mechanic's lien is acknowledged on above vehicle to secure the amount of this invoice. You will not be held responsible for loss or damage to vehicle due to fire, theft, accident, dynamometer testing or any other cause beyond your control. In the event legal action is necessary to enforce this contract, I understand that I am solely responsible for all costs including attorney's fees and court costs. I have read and understand the above and acknowledge receipt of an estimate.

DATE: [blank] TIME: [blank] PHONE • FAX • EMAIL: [blank]
 REVISION ESTIMATE \$ [blank] REASON: [blank]
 PHONE EMAIL IN PERSON FAX
 I acknowledge notice and oral approval of an increase in the original estimated price.

TOTAL WORK	
CERTIFICATE	
E.T.F.	
SUB TOTAL	
SALES TAX	
GRAND TOTAL	58 99

Smog Check Vehicle Inspection Report (VIR)

Vehicle Information

Test Date/Time: 12/14/2012 @ 16:59

Model Year: 1986	Make: PORSCHE	Model: 911 CARRERA
License: 1PCY741	State: CA	VIN: WPOAB0916GS120538
Engine Size: 3.2 L	Type: Passenger	Transmission: Manual
GVWR: N/A	Test Weight: 3000	Cylinders: 6
Odometer: 235179	Certification: California	VLT Record #: 18708
Fuel Type: Gasoline	Exhaust: Single	Inspection Reason: High Emitter Profile

Overall Test Results

Congratulations! Your vehicle passed the enhanced Smog Check inspection, which helps California reach its daily goal of removing an extra 100 tons of smog-forming emissions from the air. Thank you for keeping your vehicle well maintained.

Smog Check Certificate Number: OS179749
DMV ID Number: **3478S0530258**

Your Smog Check certificate has been electronically transmitted to DMV.
Your certificate is valid for 90 days from date of issuance.
Please keep this copy for your records.

Emission Control Systems Visual Inspection/Functional Check Results

(Visual/Functional tests are used to assist in the identification of crankcase and cold start emissions which are not measured during the ASM test)

Result	ECS	Result	ECS	Result	ECS
Pass	PCV	Pass	Thermostatic Air Cleaner	Pass	Fuel Evaporative Controls
Pass	Catalytic Converter	N/A	Air Injection	N/A	MIL/Check Engine Light
N/A	EGR Visual	Pass	Vacuum Lines to Sensors/ Switches	Pass	Carb./Fuel Injection
N/A	EGR Functional	N/A	Ignition Timing:	Pass	Other Emission Related Components
Pass	Fuel Cap Functional	Pass	Wiring to Sensors	Pass	Oxygen Sensor
Pass	Fuel Cap Visual	N/A	Fillpipe Restrictor	Pass	Liquid Fuel Leaks
Pass	Spark Controls				
Pass	Fuel Evaporative Controls Functional				

ASM Emission Test Results

Test	RPM	%CO ₂		HC (PPM)			CO (%)			NO (PPM)			Results
		MEAS	MEAS	MAX	AVE	MEAS	MAX	AVE	MEAS	MAX	AVE	MEAS	
15 mph	1511	14.1	0.7	138	29	20	0.85	0.20	0.01	804	314	697	PASS
25 mph	1700	14.2	0.5	113	25	19	0.65	0.14	0.04	685	275	682	PASS

MAX = Maximum Allowable Emissions

AVE = Average Emissions For Passing Vehicles

MEAS = Amount Measured

Smog Check Inspection Station Information

A+ Test Only Smog Service
6811 Redwood Dr. Ste. B Cotati, CA 94931
(707) 792-1512
Station Number: TB237679

Technician Name/Number: ROBINSON, JAMES/EA308583
Repair Tech Name/Number:
Software Version/EIS Number: 0903/ES819075

I certify, under penalty of perjury, under the laws of the State of California, that I performed the inspection in accordance with all bureau requirements, and that the information listed on this vehicle inspection report is true and accurate.

12-14-12
Date

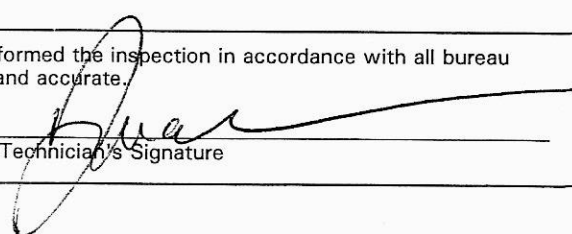
Technician's Signature

REPAIR ORDER

DE JUNG MOTORSPORT
 459 PORTAL ST SUITE A
 COTATI, CA 94931
 707-664-8002
 BAR #ARD 101025
 EPA# CAL000064429

R/O # : **14968**
 Name :
 Date : 12/14/2012
 License # : 1PCY741
 Make : PORSCHE
 Model : CARRERA
 Year : 86
 Odometer : 235179 Save Parts : NO
 VIN : WPOAB0916GS120538

, CA
 Home: _____
 Work: _____
 Other: _____

LABOR	AMOUNT
Peform intake/combustion chamber clean out.	50.00

PARTS	All parts new unless stated used or remanufactured	PRICE	QTY	AMOUNT
	INTAKE/COMBUSTION CHAMBER CLEANER	18.99	1	18.99

SUBLETS	AMOUNT
Inspection	58.00

Original Estimate : 128.60

Date	Increases to Estimate				Increase
	Time	OK'd By	Phone	Emp.	

LABOR	50.00
PARTS	18.99
SUBLETS	58.00
	.00
SUB TOTAL	126.99
TAX	1.61
TOTAL	128.60

Conditionally guaranteed 4,000 mi/ 90 days.

DEJUNG MOTORSPORT to perform the repair work listed above along with necessary materials. You and your employees may operate the above vehicle
 inspection, or delivery at my risk. An express mechanics lien is acknowledged on above vehicle to secure the amount of repairs. Thereto it is
 many assumes no responsibility for loss or damage by theft or fire to vehicles placed with them for storage, sale, repair, or while road testing.

Date : _____

REPAIR ORDER

DE JUNG MOTORSPORT
459 PORTAL ST SUITE A
COTATI, CA 94931
707-664-8002
BAR #ARD 101025
EPA# CAL000064429

R/O # : 14950
Name : I
Date : 12/05/2012
License # : 1PCY741
Make : PORSCHE
Model : CARRERA
Year : 86
Odometer : 234953 Save Parts : NO
VIN : WPOAB0916GS120538

, CA
Home: 12
Work: 14
Other:

LABOR	AMOUNT
Change engine oil and filter.	
Check transaxle oil level.	100.00
Inspect brakes.	
Check tire pressures.	
Check lights.	
Check brake fluid level.	
Car has not started on a few occasions, during or after a rain.	
Inspect distributor cap for moisture or carbon tracking. None found.	30.00
Inspect spark plug wire ends at the distributor cap and coil. No issues found.	
Put dielectric grease at ignition wire ends at the distributor cap and the coil.	
R&R right door contact. Install a diaphragm seal at the switch.	
Install a diaphragm seal at the left door contact.	25.00
Deliver car for inspection.	.00
Check out drivers seat, heater switch.	.00
Power from the fuse panel area is getting to the seat heater control unit (under the seat). There are no signals on either side of the seat control unit as the on/off switch is activated. *Need installation /wiring instructions*	

PARTS	All parts new unless stated used or remanufactured	PRICE	QTY	AMOUNT
OC 54	OIL FILTER	19.08	1	19.08
15	**CASTROL OIL(PTS.)	3.00	22	66.00
4602227	COPPER WASHER	.94	2	1.88

REPAIR ORDER

DE JUNG MOTORSPORT
 459 PORTAL ST SUITE A
 COTATI, CA 94931
 707-664-8002
 BAR #ARD 101025
 EPA# CAL000064429

R/O # : 14950

Page : 2

Name :

Date : 12/05/2012

License # : 1PCY741

Make : PORSCHE

Model : CARRERA

Year : 86

Odometer : 234953

Save Parts : NO

VIN : WPOAB0916GS120538

I _____

, CA

Home:

Work: 4

Other:

Item #	Description	Unit Price	Quantity	Total Price
01	TECHRON	9.00	1	9.00
03	WASHER SOLVENT	3.50	1	3.50
964 613 601 00	DOOR CONTACT SWITCH	13.88	1	13.88
901 615 616 20	RUBBER CAP	3.74	2	7.48

SUBLETS

Inspection, failed 12/5/2012

AMOUNT
 .00

Original Estimate : 294.29

Increases to Estimate					
Date	Time	OK'd By	Phone	Emp.	Increase

LABOR	155.00
PARTS	120.82
SUBLETS	.00
	.00
HAZARDOUS MATERIALS	8.20
SUB TOTAL	284.02
TAX	10.27
TOTAL	294.29

Parts & labor conditionally guaranteed 4,000 mi./ 90 days.

I hereby authorize DEJUNG MOTORSPORT to perform the repair work listed above along with necessary materials. You and your employees may operate the above vehicle for purposes of testing, inspection, or delivery at my risk. An express mechanics lien is acknowledged on above vehicle to secure the amount of repairs. Thereto it is understood that this company assumes no responsibility for loss or damage by theft or fire to vehicles placed with them for storage, sale, repair, or while road testing.

Authorized by : _____ Date : _____

REPAIR ORDER

DE JUNG MOTORSPORT
459 PORTAL ST SUITE A
COTATI, CA 94931
707-664-8002
BAR #ARD 101025
EPA# CAL000064429

R/O # : 14317
Name :
Date : 08/18/2011
License # : 1PCY741
Make : PORSCHE
Model : CARRERA
Year : 86
Odometer : 225422 Save Parts : NO
VIN : WPOAB0916GS120538

, CA

Home:

Work:

Other:

LABOR

AMOUNT

Change engine oil and filter.	100.00
Check transaxle oil level.	
Inspect brakes.	
Check tire pressures.	
Check lights.	
Check brake fluid level.	
Inspect brakes:	.00
Reart brake wear sensor is worn into.	
Rear brake rotors measure .915" (minimum allowed .890")	
Front brake pad sensor is just touching.	
Front brake rotors measure .866" (minimum allowed .890")	
R&R front brake rotors, pads and wear sensor.	200.00
R&R rear brake pads and wear sensors.	100.00

PARTS All parts new unless stated used or remanufactured

	PRICE	QTY	AMOUNT
911 351 041 22 BRAKE ROTOR	148.63	2	297.26
911 351 950 06 BRAKE PADS	67.40	1	67.40
993 612 965 01 BRAKE PAD SENSOR	21.58	2	43.16
911 352 950 04 BRAKE PAD SET	74.14	1	74.14
944 612 211 02 BRAKE PAD SENSOR	23.10	2	46.20

REPAIR ORDER

DE JUNG MOTORSPORT
 459 PORTAL ST SUITE A
 COTATI, CA 94931
 707-664-8002
 BAR #ARD 101025
 EPA# CAL000064429

R/O # : 14317 Page : 2
 Name :
 Date : 08/18/2011
 License # : 1PCY741
 Make : PORSCHE
 Model : CARRERA
 Year : 86
 Odometer : 225422 Save Parts : NO
 VIN : WPOAB0916GS120538

, CA
 Home:
 Work:
 Other:

PARTS	All parts new unless stated used or remanufactured	PRICE	QTY	AMOUNT
OC 54	OIL FILTER	19.08	1	19.08
10	**ENGINE OIL(PTS.)	2.45	22	53.90
4602227	COPPER WASHER	.80	2	1.60
01	TECHRON	9.00	1	9.00
03	WASHER SOLVENT	3.50	1	3.50

Original Estimate : 1,081.89

Increases to Estimate					
Date	Time	OK'd By	Phone	Emp.	Increase

LABOR	400.00
PARTS	615.24
SUBLETS	.00
HAZARDOUS MATERIALS	.00
SUB TOTAL	8.20
TAX	1,023.44
TOTAL	58.45
TOTAL	1,081.89

Parts & labor conditionally guaranteed 4,000 mi./ 90 days.

I hereby authorize DEJUNG MOTORSPORT to perform the repair work listed above along with necessary materials. You and your employees may operate the above vehicle for purposes of testing, inspection, or delivery at my risk. An express mechanics lien is acknowledged on above vehicle to secure the amount of repairs. Thereto it is understood that this company assumes no responsibility for loss or damage by theft or fire to vehicles placed with them for storage, sale, repair, or while road testing.

Authorized by : _____ Date : _____

REPAIR ORDER

DE JUNG MOTORSPORT
 459 PORTAL ST SUITE A
 COTATI, CA 94931
 707-664-8002
 BAR #ARD 101025
 EPA# CAL000064429

R/O # : 14218
 Name :]
 Date : 06/07/2011
 License # : 1PCY741
 Make : PORSCHE
 Model : CARRERA
 Year : 86
 Odometer : 223957 Save Parts : NO
 VIN : WPOAB0916GS120538

I _____ /N

, CA

Home: _____

Work: _____

Other: _____

LABOR

	AMOUNT
Check out non op AC syhstem: There is very little pressure in the system. Evacuate the AC system. The system pulled down to 30 in. Let the car sit for 1 hour 20 minutes. The gauges still read 30in. Charge the AC system. The vent temps were 41'-43'	125.00
R&I the sunroof wind deflector. R&I the front trim. Install 2 new wind deflector clips into the front trim piece.	25.00
Check out non op front seat heater. R&R the fuse at the front fuse panel. Trace the short to 2 wires that had come off of the on/off switch. Reinstall the wires and tape the 4 wires together at the on/off switch.	75.00

PARTS	All parts new unless stated used or remanufactured	PRICE	QTY	AMOUNT
911 564 123 00	DEFLECTOR CLIP	3.79	2	7.58
	15AMP FUSE	.70	1	.70
R-12	FREON P/OZ	3.50	41	143.50

Original Estimate : 391.20

Increases to Estimate					
Date	Time	OK'd By	Phone	Emp.	Increase

LABOR	225.00
PARTS	151.78
SUBLETS	.00
	.00
SUB TOTAL	376.78
TAX	14.42
TOTAL	<u>391.20</u>

Parts & labor conditionally guaranteed 4,000 mi./ 90 days.

I hereby authorize DEJUNG MOTORSPORT to perform the repair work listed above along with necessary materials. You and your employees may operate the above vehicle for purposes of testing, inspection, or delivery at my risk. An express mechanics lien is acknowledged on above vehicle to secure the amount of repairs. Thereto it is understood that this company assumes no responsibility for loss or damage by theft or fire to vehicles placed with them for storage, sale, repair, or while road testing.

Authorized by : _____ Date : _____

DEPENDABLE TIRE & BRAKE

Phone (415) 456-2311
Fax (415) 456-8740

25 Market Street
San Rafael, CA 94901

BAR# AG126629
EPA# CAL 000 012 611

INVOICE PENDING PAYMENT

ID
SEBASTOPOL, CA 95472-
HOME PHONE (707) _____ HOME (707) _____
86/PORSCH 911 1PCY741 CA BLUE P/T: 03/01/11 @ 17:00 ENGINE
V.I.N. NUMBER _____ MILEAGE 211,655

PART NO.	DESCRIPTION	PRICE
2 39214	225/50R16 MICH PLT A/	404.26
2 STEMS	STD VALVE STEM	.00
1 ALLOY TAPE	ALLOY WEIGHTS/TAPE	4.00

CODE	LABOR OPERATION	PRICE
------	-----------------	-------

	DISPOSAL FEE (*)	5.50
	CA RECYCLING FEE	3.50
036	BALANCE TIRE(S)	30.00
	2 NEW TIRES MOUNTED AT REAR	
036	CHECK TIRE PRESSURES	
	AS PER CALIFORNIA LAW, SEE SETTINGS BELOW.	

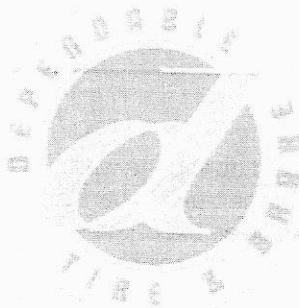

LF 32 PSI, RF 32 PSI
LR 36 PSI, RR 36 PSI

CELL # 707-292-9046 BEEPER OTHER

I HEREBY AUTHORIZE THE ABOVE REPAIR WORK TO BE DONE ALONG WITH THE NECESSARY MATERIAL AND HEREBY GRANT YOU AND/OR YOUR EMPLOYEES PERMISSION TO OPERATE THE VEHICLE HEREIN DESCRIBED ON STREETS, HIGHWAYS OR ELSEWHERE FOR THE PURPOSE OF TESTING AND/OR INSPECTION. AN EXPRESS MECHANIC'S LIEN IS HEREBY ACKNOWLEDGED ON ABOVE VEHICLE TO SECURE THE AMOUNT OF REPAIRS THERETO. I UNDERSTAND THAT THIS REPAIR FACILITY IS NOT AN INSURER OF SAID VEHICLE AND WILL NOT BE HELD RESPONSIBLE FOR LOSS OR DAMAGE TO VEHICLE OR ARTICLES LEFT IN VEHICLE IN CASE OF FIRE, THEFT, ACCIDENT OR ANY OTHER CAUSE BEYOND YOUR CONTROL. A STORAGE FEE OF \$10.00 PER DAY WILL BE ADDED TO REPAIR BILL IF VEHICLE IS NOT PICKED UP WITHIN THREE (3) WORKING DAYS OF COMPLETION OF WORK.

AUTHORIZED BY

ORIGINAL ESTIMATE 486.04

I ACKNOWLEDGE NOTICE AND ORAL APPROVAL OF AN INCREASE IN THE ORIGINAL ESTIMATED PRICE.

(SIGNATURE OR INITIALS)

RECOMMENDED SERVICES / FUTURE VEHICLE NEEDS

REAR BRAKES 10% REMAINING APPROX 2/1/11
1 WHEEL STUD AT RIGHT FRONT HAS CHEWED THREADS 12/4/06
RIGHT SIDE OF CAR 1/2" HIGH, RECOMEND CORNER BALANCE, RE-ALIGN
TOE ADJUSTER AT RIGHT REAR MAXED OUT, THRUST ANGLE SLIGHTLY OFF.
12/4/06

VISA	.00
M/C	.00
AM.EXP	.00
DSCVR	.00
OTHER	.00
CHECK	.00
CASH	.00
HAPA	.00
GW/WTY	.00
G. C/C	.00
ATM	.00
AM.PD.	.00

TOTALS	
PARTS	408.26
SUBLET	9.00
LABOR	30.00
SG/HW	.00
	=====
SUB TOTAL	447.26
	=====
TAX	38.78
	=====
TOTAL	486.04

CUSTOMER COPY

Road Test

NOTIFIED

PROMISED

Phone when ready
Yes NO

C = REFUNDABLE CORE DEPOSIT

DISCARD PARTS
R = REBUILT U = USED

SAVE PARTS
CODE N = NEW

REPAIR ORDER

DE JUNG MOTORSPORT
 459 PORTAL ST SUITE A
 COTATI, CA 94931
 707-664-8002
 BAR #ARD 101025
 EPA# CAL000064429

R/O # : 14064
 Name :
 Date : 01/26/2011
 License # : 1PCY741
 Make : PORSCHE
 Model : CARRERA
 Year : 86
 Odometer : 220773 Save Parts : NO
 VIN : WPOAB0916GS120538

, CA
 Home: ?
 Work: ?
 Other:

LABOR	AMOUNT
Change engine oil and filter.	
Check transaxle oil level.	100.00
Inspect brakes.	
Check tire pressures.	
Check lights.	
Check brake fluid level.	
Drain and fill transaxle with SWEPCO gear oil.	30.00

PARTS	All parts new unless stated used or remanufactured	PRICE	QTY	AMOUNT
OC 54	OIL FILTER	18.56	1	18.56
15	**CASTROL OIL(PTS.)	2.45	22	53.90
4602227	COPPER WASHER	.80	2	1.60
01	TECHRON	9.50	1	9.50
03	WASHER SOLVENT	3.50	1	3.50
GL5-S	GEAR OIL-SWEPCO 1/2 PT	4.50	12	54.00

RECOMMENDATIONS AND TECHNICIANS NOTES

REAR TIRES

Original Estimate : 294.46

Increases to Estimate					
Date	Time	OK'd By	Phone	Emp.	Increase

LABOR	130.00
PARTS	141.06
SUBLETS	.00
	.00
HAZARDOUS MATERIALS	10.00
SUB TOTAL	281.06
TAX	13.40
TOTAL	<u>294.46</u>

Parts & labor conditionally guaranteed 4,000 mi./ 90 days.

I hereby authorize DEJUNG MOTORSPORT to perform the repair work listed above along with necessary materials. You and your employees may operate the above vehicle for purposes of testing, inspection, or delivery at my risk. An express mechanics lien is acknowledged on above vehicle to secure the amount of repairs. Thereto it is understood that this company assumes no responsibility for loss or damage by theft or fire to vehicles placed with them for storage, sale, repair, or while road testing.

Authorized by : _____ Date : _____

REPAIR ORDER

DE JUNG MOTORSPORT
 459 PORTAL ST SUITE A
 COTATI, CA 94931
 707-664-8002
 BAR #ARD 101025
 EPA# CAL000064429

R/O # : 13981
 Name :
 Date : 11/19/2010
 License # : 1PCY741
 Make : PORSCHE
 Model : CARRERA
 Year : 86
 Odometer : Save Parts : NO
 VIN : WPOAB0916GS120538

, CA
 Home: 2
 Work: 4
 Other:

LABOR	AMOUNT
R&R DME relay.	.00

PARTS	All parts new unless stated used or remanufactured	PRICE	QTY	AMOUNT
911 618 154 00	RELAY, IGNITION/FUEL (DME)	47.43	1	47.43

RECOMMENDATIONS AND TECHNICIANS NOTES

Oxygen sensor is very lazy.
 Possible rear main seal.

Original Estimate : 106.69

Increases to Estimate					
Date	Time	OK'd By	Phone	Emp.	Increase

LABOR	.00
PARTS	47.43
SUBLETS	.00
	.00
SUB TOTAL	47.43
TAX	4.51
TOTAL	<u>51.94</u>

Parts & labor conditionally guaranteed 4,000 mi./ 90 days.

I hereby authorize DEJUNG MOTORSPORT to perform the repair work listed above along with necessary materials. You and your employees may operate the above vehicle for purposes of testing, inspection, or delivery at my risk. An express mechanics lien is acknowledged on above vehicle to secure the amount of repairs. Thereto it is understood that this company assumes no responsibility for loss or damage by theft or fire to vehicles placed with them for storage, sale, repair, or while road testing.

Authorized by : _____ Date : _____

REPAIR ORDER

DE JUNG MOTORSPORT
459 PORTAL ST SUITE A
COTATI, CA 94931
707-664-8002
BAR #ARD 101025
EPA# CAL000064429

R/O # : 13960
Name _____
Date : 11/04/2010
License # : 1PCY741
Make : PORSCHE
Model : CARRERA
Year : 86
Odometer : 218828 Save Parts : NO
VIN : WPOAB0916GS120538

, CA

Home:

Work: :

Other:

LABOR

AMOUNT

Smoke test the intake system.
There is smoke coming from the left side of the engine air shroud.
Remove the heater fan and the ducting to inspect the base of #1 intake manifold to cylinder head union. There is a leak at the manifold to cylinder head union.
R&I both intake manifolds complete.
R&R 12 intake manifold, base gaskets.
R&I 6 injectors and replace injector "O" ring seals.
R&R 4 fuel ring, flex hoses.
R&R the breather hose, engine breather to oil tank.
R&R the gasket at the breather hose cap at the top of the engine.
R&R vacuum hose, cruise control unit to intake.
Smoke test the intake system.
R&R the intake boot.

1,080.00

11/3/10, 2 hours 15 minutes
11/4/10, 3 hours 5 minutes
11/7/10, 4 hours 15 minutes
11/8/10, 1 hour 15 minutes

Reglue interior mirror to the windshield.

.00

PARTS	All parts new unless stated used or remanufactured	PRICE	QTY	AMOUNT
930 110 197 14	GASKET INTAKE	2.76	12	33.12
CC	CARB CLEANER	7.75	1	7.75
930 207 386 01	BREATHER HOSE	36.02	1	36.02
930 107 791 02	GASKET,BREATHER HOUSING	4.92	1	4.92

REPAIR ORDER

DE JUNG MOTORSPORT
 459 PORTAL ST SUITE A
 COTATI, CA 94931
 707-664-8002
 BAR #ARD 101025
 EPA# CAL000064429

R/O # : 13960 Page : 2
 Name : I
 Date : 11/04/2010
 License # : 1PCY741
 Make : PORSCHE
 Model : CARRERA
 Year : 86
 Odometer : 218828 Save Parts : NO
 VIN : WPOAB0916GS120538

, CA
 Home: _____
 Work: : _____
 Other: _____

PARTS	All parts new unless stated used or remanufactured	PRICE	QTY	AMOUNT
944 110 901 00	FUEL INJECTOR SEAL KIT	8.72	4	34.88
930 207 243 01	RUBBER SLEEVE	3.87	1	3.87
10MMFH	HIGH PRESSURE FUEL HOSE-10MM P/FT	6.00	3	18.00
CIS	HP HOSE-8MM P/6"	2.25	3	6.75
5395812	CLAMP	1.60	2	3.20
5391220	CLAMP	1.75	11	19.25
930 110 356 02	INTAKE BOOT	83.04	1	83.04
	MIRROR GLUE KIT	3.99	1	3.99

SUBLETS	AMOUNT
Inspection	58.00

RECOMMENDATIONS AND TECHNICIANS NOTES

Oxygen sensor is very lazy.
 Possible rear main seal.

Original Estimate : 1,417.00

Increases to Estimate					
Date	Time	OK'd By	Phone	Emp.	Increase

LABOR	1,080.00
PARTS	254.79
SUBLETS	58.00
	.00
SUB TOTAL	1,392.79
TAX	24.21
TOTAL	1,417.00

Parts & labor conditionally guaranteed 4,000 mi./ 90 days.

I hereby authorize DEJUNG MOTORSPORT to perform the repair work listed above along with necessary materials. You and your employees may operate the above vehicle for purposes of testing, inspection, or delivery at my risk. An express mechanics lien is acknowledged on above vehicle to secure the amount of repairs. Thereto it is understood that this company assumes no responsibility for loss or damage by theft or fire to vehicles placed with them for storage, sale, repair, or while road testing.

Authorized by : _____ Date : _____

Smog Check Vehicle Inspection Report (VIR)

Vehicle Information

Test Date/Time: 11/09/2010 @ 09:57

Model Year: 1986	Make: PORSCHE	Model: 911 CARRERA
License: 1PCY741	State: CA	VIN: WPOAB0916GS120538
Engine Size: 3.2 L	Type: Passenger	Transmission: Manual
GVWR: N/A	Test Weight: 3000	Cylinders: 6
Odometer: 218839	Certification: California	VLT Record #: 18708
Fuel Type: Gasoline	Exhaust: Single	Inspection Reason: High Emitter Profile

Overall Test Results

Congratulations! Your vehicle passed the enhanced Smog Check inspection, which helps California reach its daily goal of removing an extra 100 tons of smog-forming emissions from the air. Thank you for keeping your vehicle well maintained.

Smog Check Certificate Number: NY487151
DMV ID Number: **3778Y058N158**

Your Smog Check certificate has been electronically transmitted to DMV.
Your certificate is valid for 90 days from date of issuance.
Please keep this copy for your records.

Emission Control Systems Visual Inspection/Functional Check Results

(Visual/Functional tests are used to assist in the identification of crankcase and cold start emissions which are not measured during the ASM test)

Result	ECS	Result	ECS	Result	ECS
Pass	PCV	N/A	Thermostatic Air Cleaner	Pass	Fuel Evaporative Controls
Pass	Catalytic Converter	N/A	Air Injection	N/A	MIL/Check Engine Light
N/A	EGR Visual	Pass	Vacuum Lines to Sensors/ Switches	Pass	Carb./Fuel Injection
N/A	EGR Functional		Ignition Timing: 3 BTDC	Pass	Other Emission Related Components
Pass	Fuel Cap Functional	Pass	Wiring to Sensors	Pass	Oxygen Sensor
Pass	Fuel Cap Visual	Pass	Fillpipe Restrictor	Pass	Liquid Fuel Leaks
Pass	Spark Controls	N/A			
N/A	Fuel Evaporative Controls Functional				

ASM Emission Test Results

Test	RPM	%CO ₂		HC (PPM)			CO (%)			NO (PPM)			Results
		MEAS	MEAS	MAX	AVE	MEAS	MAX	AVE	MEAS	MAX	AVE	MEAS	
15 mph	1479	14.4	0.4	138	29	33	0.85	0.20	0.38	804	314	270	PASS
25 mph	1732	14.4	0.8	113	25	27	0.65	0.14	0.48	685	275	263	PASS

MAX = Maximum Allowable Emissions

AVE = Average Emissions For Passing Vehicles

MEAS = Amount Measured

Smog Check Inspection Station Information

A+ Test Only Smog Service
6811 Redwood Dr. Ste. B Cotati, CA 94931
(707) 792-1512
Station Number: TB237679

Technician Name/Number: BLACKWELL, GARY/EA086938
Repair Tech Name/Number:
Software Version/EIS Number: 0903/ES819075

I certify, under penalty of perjury, under the laws of the State of California, that I performed the inspection in accordance with all bureau requirements, and that the information listed on this vehicle inspection report is true and accurate.

_____ Date

Technician's Signature

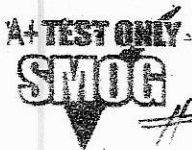

A+ TEST ONLY SERVICE OF COTATI
6811 Redwood Dr., Ste. B • Cotati, CA 94931

NO 27385

Phone (707) 792-1512

SMOG TEST-ONLY
INVOICE

28539

BAR No. AB237679

NAME 1	TODAY'S DATE 11-9-10	YEAR 86	MAKE Porsche	MODEL 911
ADDRESS 1	ODOMETER 218839	LIC. PLATE # 1PCY741	MOTOR #	
CITY, STATE ZIP 506 Cu 95473	WRITTEN BY	CUSTOMER P.O. #	G.V.W.R.	
HOME PHONE ()	<input type="checkbox"/> WORK <input type="checkbox"/> CELL <input type="checkbox"/> PAGER	TEST TYPE: <input type="checkbox"/> BIENNIAL <input type="checkbox"/> CHANGE OF OWNERSHIP <input type="checkbox"/> 2% <input type="checkbox"/> HEP <input type="checkbox"/> INITIAL	<input type="checkbox"/> FED. <input type="checkbox"/> CALIF. <input type="checkbox"/> O/S	ENGINE 3.0 # OF CYLINDERS 6
METHOD OF PAYMENT: <input type="checkbox"/> CASH <input checked="" type="checkbox"/> CHECK <input type="checkbox"/> CHARGE <input type="checkbox"/> DEBIT CARD <input type="checkbox"/> CREDIT CARD	ORIGINAL ESTIMATE \$ 58.00	TRANSMISSION: <input type="checkbox"/> AUTO <input checked="" type="checkbox"/> STD	TIMING 30	EM. LIGHT
V. I. N.				

SMOG TEST CHECK OFF					
P-Pass	M-Modified	F-Defective	D-Disconnected	S-Missing	N-N/A
PCV <i>P</i>			CKP <i>P</i>		
TAC <i>P</i>			AP/P <i>P</i>		
EVP <i>P</i>			OXY		
CAT <i>P</i>			WRG		
EGR <i>P</i>			VAC		
SPK <i>P</i>			OTH		

SMOKE INSPECTION: PCV TAILPIPE

Tire Pressure Inspection Performed: LF _____ RR _____ (psi)

Tire Pressure Inspection Declined. Reason:

Asm/ Huss

OPR.	DESCRIPTION OF WORK	AMOUNT
	SMOG TEST	79.75
	PRETEST <input type="checkbox"/> YES <input type="checkbox"/> NO	
	CERTIFICATE #	8.25
	ELECTRONIC TRANSFER FEE (E.T.F.)	
	RETEST	
	GAS CAP	
	<i>P. work</i> LOW PRESSURE FUEL EVAP TEST (LRFET)	-30.00

TEST RESULTS: PASS FAIL ABORT

THIS SMOG TEST-ONLY STATION CANNOT PERFORM ANY DIAGNOSTICS, ADJUSTMENTS OR REPAIRS

I hereby authorize the above smog test to be performed. Smog test fee is due whether above vehicle passes or fails the smog test. You and your employees may operate above vehicle for purposes of testing, inspection and delivery at my risk. An express mechanic's lien is acknowledged on above vehicle to secure the amount of this invoice. You will not be held responsible for loss or damage to vehicle due to fire, theft, accident, dynamometer testing or any other cause beyond your control. In the event legal action is necessary to enforce this contract, I understand that I am solely responsible for all costs including attorney's fees and court costs. I have read and understand the above and acknowledge receipt of an estimate.

[Signature] DATE: _____

REVISOR: _____ DATE: _____ TIME: _____ PHONE/FAX/EMAIL: _____

REASON: _____

PHONE EMAIL IN PERSON FAX

ADDITIONAL COST \$ _____

I acknowledge notice and oral approval of an increase in the original estimated price.

TOTAL WORK	
CERTIFICATE	
E.T.F.	
SUB TOTAL	
SALES TAX	
GRAND TOTAL	58.00

REPAIR ORDER

DE JUNG MOTORSPORT
 459 PORTAL ST SUITE A
 COTATI, CA 94931
 707-664-8002
 BAR #ARD 101025
 EPA# CAL000064429

R/O # : 13731
 Name
 Date : 05/20/2010
 License # : 1PCY741
 Make : PORSCHE
 Model : CARRERA
 Year : 86
 Odometer : 215750 Save Parts : NO
 VIN : WPOAB0916GS120538

I
 , CA
 5

LABOR	AMOUNT
R&R ignition wire set.	130.00
Install recovered steering wheel.	.00

PARTS	All parts new unless stated used or remanufactured	PRICE	QTY	AMOUNT
911 602 011 90	IGNITION WIRE SET	393.75	1	393.75

RECOMMENDATIONS AND TECHNICIANS NOTES

Oxygen sensor is very lazy.
 Possible rear main seal.

Original Estimate : 559.19

Increases to Estimate					
Date	Time	OK'd By	Phone	Emp.	Increase

Parts & labor conditionally guaranteed 4,000 mi./ 90 days.

LABOR	130.00
PARTS	393.75
SUBLETS	.00
	.00
SUB TOTAL	523.75
TAX	35.44
TOTAL	559.19

I hereby authorize DEJUNG MOTORSPORT to perform the repair work listed above along with necessary materials. You and your employees may operate the above vehicle for purposes of testing, inspection, or delivery at my risk. An express mechanics lien is acknowledged on above vehicle to secure the amount of repairs. Thereto it is understood that this company assumes no responsibility for loss or damage by theft or fire to vehicles placed with them for storage, sale, repair, or while road testing.

Authorized by : _____ Date : _____

REPAIR ORDER

DE JUNG MOTORSPORT
 459 PORTAL ST SUITE A
 COTATI, CA 94931
 707-664-8002
 BAR #ARD 101025
 EPA# CAL000064429

R/O # : 13796
 Name :
 Date : 07/08/2010
 License # : 1PCY741
 Make : PORSCHE
 Model : CARRERA
 Year : 86
 Odometer : 216760 Save Parts : NO
 VIN : WPOAB0916GS120538

, CA

Home:

Work:

Other:

LABOR

	AMOUNT
R&I AC evaporator, fan/motor assembly.	110.00
Check for poor off idle throttle response.	.00
Smoke test the engine. Slight smoke seen at the area around #1 intake port (will need to inspect further).	.00
Ignition distributor advance checked. OK.	
The oxygen sensor is disconnected (because of sluggish operation).connect the sensor to see if there is any change in throttle response.	

PARTS All parts new unless stated used or remanufactured		PRICE	QTY	AMOUNT
911 624 906 00	A/C EVAPORATOR MOTOR/FAN	277.48	1	277.48

RECOMMENDATIONS AND TECHNICIANS NOTES

Oxygen sensor is very lazy.
 Possible rear main seal.

Original Estimate : 412.45

Increases to Estimate					
Date	Time	OK'd By	Phone	Emp.	Increase

LABOR	110.00
PARTS	277.48
SUBLETS	.00
	.00
SUB TOTAL	387.48
TAX	24.97
TOTAL	412.45

Parts & labor conditionally guaranteed 4,000 mi./ 90 days.

I hereby authorize DEJUNG MOTORSPORT to perform the repair work listed above along with necessary materials. You and your employees may operate the above vehicle for purposes of testing, inspection, or delivery at my risk. An express mechanics lien is acknowledged on above vehicle to secure the amount of repairs. Thereto it is understood that this company assumes no responsibility for loss or damage by theft or fire to vehicles placed with them for storage, sale, repair, or while road testing.

Authorized by : _____ Date : _____

REPAIR ORDER

deJung Motorsport
 459 Portal St. Suite A
 Cotati, CA 94931
 (707) 664-8002
 BAR #ARD 101025
 EPA# CAL000064429

R/O # : 13647
 Name _____
 Date : 03/17/2010
 License # : 1PCY741
 Make : PORSCHE
 Model : CARRERA
 Year : 86
 Mileage : 214468 Save Parts : NO
 VIN : WPOAB0916GS120538

I _____
 CA _____

LABOR	AMOUNT
Major Service:	600.00
Tune up.	
Adjust valves.	
Full service.	
R&R rear deck lid, shock.	.00
Check for intake spit-back, when changing throttle position.	.00
Smoke test the intake system. Passed.	
After the Major Service was completed the spit-back seems to have ended	

PARTS	All parts new unless stated used or remanufactured	PRICE	QTY	AMOUNT
OC 54	OIL FILTER	18.68	1	18.68
930 110 393 00	AIR FILTER	22.05	1	22.05
928 110 147 05	FUEL FILTER	39.94	1	39.94
999 170 156 90	SPARK PLUG	4.77	6	28.62
930 602 919 00	CAP	79.68	1	79.68
930 602 902 01	ROTOR	23.78	1	23.78
PK 03	V/C GASKET KIT	56.73	1	56.73
15	**CASTROL OIL(PTS.)	2.45	22	53.90
01	TECHRON	8.50	1	8.50
03	WASHER SOLVENT	3.50	1	3.50
911 512 331 02	STRUT	30.27	1	30.27

RECOMMENDATIONS AND TECHNICIANS NOTES

Rear tires are at the wear bars.
 Oxygen sensor is very lazy.
 Possible rear main seal.

Original Estimate : 1,006.76

Increases to Estimate					
Date	Time	OK'd By	Phone	Emp.	Increase

LABOR	600.00
PARTS	365.65
SUBLETS	.00
	.00
HAZARDOUS MATERIALS	8.20
SUB TOTAL	973.85
TAX	32.91
TOTAL	1,006.76

Parts & labor conditionally guaranteed 4,000 mi./ 90 days.

I hereby authorize DEJUNG MOTORSPORT to perform the repair work listed above along with necessary materials. You and your employees may operate the above vehicle for purposes of testing, inspection, or delivery at my risk. An express mechanics lien is acknowledged on above vehicle to secure the amount of repairs. Thereto it is understood that this company assumes no responsibility for loss or damage by theft or fire to vehicles placed with them for storage, sale, repair, or while road testing.

Authorized by : _____ Date : _____

REPAIR ORDER

deJung Motorsport
 459 Portal St. Suite A
 Cotati, CA 94931
 (707) 664-8002
 BAR #ARD 101025
 EPA# CAL000064429

R/O # : 13631
 Name _____
 Date : 03/06/2010
 License # : 1PCY741
 Make : PORSCHE
 Model : CARRERA
 Year : 86
 Mileage : 214261 Save Parts : NO
 VIN : WPOAB0916GS120538

, CA

LABOR	AMOUNT
Remove steering wheel. Send out for recover. 1/22/10	.00
R&R high-low / turn signal switch.	.00
R&R wiper switch.	.00
R&R left rear turn signal bulb.	.00
R&R both front hood shocks.	.00
ALL ABOVE TIME	200.00
Check for missfire / backfire ? (this occurs with throttle movement)	.00

PARTS	All parts new unless stated used or remanufactured	PRICE	QTY	AMOUNT
911 613 305 01	TURN SIGNAL / HIGH-LOW SWITCH	160.04	1	160.04
911 613 306 02	WIPER SWITCH	153.71	1	153.71
911 511 331 00	HOOD STRUT	34.54	2	69.08
1156	BULB	2.08	1	2.08

SUBLETS	AMOUNT
Freight	25.67
Recover steering wheel	200.00
Freight/COD	33.00

Original Estimate : 878.22

Increases to Estimate					
Date	Time	OK'd By	Phone	Emp.	Increase

Parts & labor conditionally guaranteed 4,000 mi./ 90 days.

LABOR	200.00
PARTS	384.91
SUBLETS	258.67
	.00
SUB TOTAL	843.58
TAX	34.64
TOTAL	<u>878.22</u>

I hereby authorize DEJUNG MOTORSPORT to perform the repair work listed above along with necessary materials. You and your employees may operate the above vehicle for purposes of testing, inspection, or delivery at my risk. An express mechanics lien is acknowledged on above vehicle to secure the amount of repairs. Thereto it is understood that this company assumes no responsibility for loss or damage by theft or fire to vehicles placed with them for storage, sale, repair, or while road testing.

Authorized by : _____ Date : _____

Invoice

BK Upholstery
 445 Portal Street Suite 3
 Cotati, CA 94931
 707-794-9307

Date	Invoice #
2/5/2010	3269

Bill To
T 1 Sebastopo, Ca 95473

P.O. No.	Terms	Project

Quantity	Description	Rate	Amount
	Labor to install front seat covers & driver seat heater unit	600.00	600.00
	1986 Carrera 911 vin#WP0AB0916GS120538 lic#IPCY741 Sales Tax	9.00%	0.00
Total			\$600.00

REPAIR ORDER

deJung Motorsport
 459 Portal St. Suite A
 Cotati, CA 94931
 (707) 664-8002
 BAR #ARD 101025
 EPA# CAL000064429

R/O # : 13445
 Name
 Date : 09/30/2009
 License # : 1PCY741
 Make : PORSCHE
 Model : CARRERA
 Year : 86
 Mileage : 210636 Save Parts : NO
 VIN : WPOAB0916GS120538

I
 , CA
 :

LABOR	AMOUNT
Change engine oil and filter.	100.00
Check transaxle oil level.	
Inspect brakes.	
Check tire pressures.	
Check lights.	
Check brake fluid level.	
 FIX RATTLE	 .00

PARTS	All parts new unless stated used or remanufactured	PRICE	QTY	AMOUNT
OC 54	OIL FILTER	16.74	1	16.74
10	**ENGINE OIL(PTS.)	2.45	22	53.90
4602227	COPPER WASHER	.80	2	1.60
01	TECHRON	8.46	1	8.46
03	WASHER SOLVENT	3.50	1	3.50

Original Estimate : 199.98

Increases to Estimate					
Date	Time	OK'd By	Phone	Emp.	Increase

LABOR	100.00
PARTS	84.20
SUBLETS	.00
	.00
HAZARDOUS MATERIALS	8.20
SUB TOTAL	192.40
TAX	7.58
TOTAL	<u>199.98</u>

Parts & labor conditionally guaranteed 4,000 mi./ 90 days.

I hereby authorize DEJUNG MOTORSPORT to perform the repair work listed above along with necessary materials. You and your employees may operate the above vehicle for purposes of testing, inspection, or delivery at my risk. An express mechanics lien is acknowledged on above vehicle to secure the amount of repairs. Thereto it is understood that this company assumes no responsibility for loss or damage by theft or fire to vehicles placed with them for storage, sale, repair, or while road testing.

Authorized by : _____ Date : _____

Smog Check Vehicle Inspection Report (VIR)

Vehicle Information

Test Date/Time: 12/03/2008 @ 16:28

Model Year: 1986	Make: PORSCHE	Model: 911 CARRERA
License: 1PCY741	State: CA	VIN: WPOAB0916GS120538
Engine Size: 3.2 L	Type: Passenger	Transmission: Manual
GVWR: N/A	Test Weight: 3000	Cylinders: 6
Odometer: 203076	Certification: California	VLT Record #: 09008
Fuel Type: Gasoline	Exhaust: Single	Inspection Reason: High Emitter Profile

Overall Test Results

Congratulations! Your vehicle passed the enhanced Smog Check inspection, which helps California reach its daily goal of removing an extra 100 tons of smog-forming emissions from the air. Thank you for keeping your vehicle well maintained.

Smog Check Certificate Number: NG172119
 DMV ID Number: **3976G054N158**

Your Smog Check certificate has been electronically transmitted to DMV.
 Your certificate is valid for 90 days from date of issuance.
 Please keep this copy for your records.

Emission Control Systems Visual Inspection/Functional Check Results

(Visual/Functional tests are used to assist in the identification of crankcase and cold start emissions which are not measured during the ASM test)

Result	ECS	Result	ECS	Result	ECS
Pass	PCV	N/A	Thermostatic Air Cleaner	Pass	Fuel Evaporative Controls
Pass	Catalytic Converter	N/A	Air Injection	Pass	MIL/Check Engine Light
N/A	EGR Visual	Pass	Vacuum Lines to Sensors/	Pass	Carb./Fuel Injection
N/A	EGR Functional		Switches	Pass	Other Emission Related
Pass	Fuel Cap Functional	N/A	Ignition Timing:		Components
Pass	Fuel Cap Visual	Pass	Wiring to Sensors	Pass	Oxygen Sensor
Pass	Spark Controls	N/A	Fillpipe Restrictor	Pass	Liquid Fuel Leaks
N/A	Fuel Evaporative Controls Functional				

ASM Emission Test Results

Test	RPM	%CO ₂		%O ₂			HC (PPM)			CO (%)			NO (PPM)			Results
		MEAS	MEAS	MAX	AVE	MEAS	MAX	AVE	MEAS	MAX	AVE	MEAS				
15 mph	1506	13.3	2.6	138	41	18	0.85	0.13	0.00	1148	399	762	PASS			
25 mph	1740	13.3	2.5	113	29	15	0.65	0.11	0.00	978	332	950	PASS			

MAX = Maximum Allowable Emissions

AVE = Average Emissions For Passing Vehicles

MEAS = Amount Measured

Smog Check Inspection Station Information

A + Test Only Smog Service
 6811 Redwood Dr. Ste. B Cotati, CA 94931
 (707) 792-1512
 Station Number: TB237679

Technician Name/Number: BLACKWELL, GARY/EA086938
 Repair Tech Name/Number:
 Software Version/EIS Number: 0403/ES819075

I certify, under penalty of perjury, under the laws of the State of California, that I performed the inspection in accordance with all bureau requirements, and that the information listed on this vehicle inspection report is true and accurate.

12.3.8
 Date

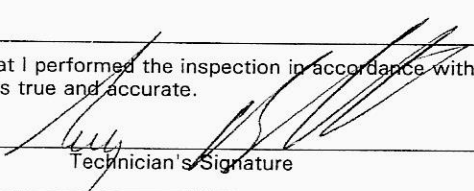
 Technician's Signature

Smog Check Vehicle Inspection Report (VIR)

Vehicle Information

Test Date/Time: 12/03/2008 @ 15:08

Model Year: 1986	Make: PORSCHE	Model: 911 CARRERA
License: 1PCY741	State: CA	VIN: WPOAB0916GS120538
Engine Size: 3.2 L	Type: Passenger	Transmission: Manual
GVWR: N/A	Test Weight: 3000	Cylinders: 6
Odometer: 203068	Certification: California	VLT Record #: 09008
Fuel Type: Gasoline	Exhaust: Single	Inspection Reason: High Emitter Profile

Overall Test Results

Comprehensive Visual Inspection: **PASS** Functional Check: **PASS** Emissions Test: **FAIL**

Repairing your vehicle is necessary to help California reduce smog-forming emissions and reach our air quality goals.

Emission Control Systems Visual Inspection/Functional Check Results

(Visual/Functional tests are used to assist in the identification of crankcase and cold start emissions which are not measured during the ASM test)

Result	ECS	Result	ECS	Result	ECS
Pass	PCV	N/A	Thermostatic Air Cleaner	Pass	Fuel Evaporative Controls
Pass	Catalytic Converter	N/A	Air Injection	N/A	MIL/Check Engine Light
N/A	EGR Visual	Pass	Vacuum Lines to Sensors/ Switches	Pass	Carb./Fuel Injection
N/A	EGR Functional		Ignition Timing:	Pass	Other Emission Related Components
Pass	Fuel Cap Functional	N/A	Wiring to Sensors	Pass	Oxygen Sensor
Pass	Fuel Cap Visual	Pass	Fillpipe Restrictor	Pass	Liquid Fuel Leaks
Pass	Spark Controls	N/A			
N/A	Fuel Evaporative Controls Functional				

ASM Emission Test Results

Test	RPM	%CO ₂		%O ₂			HC (PPM)			CO (%)			NO (PPM)			Results
		MEAS	MEAS	MAX	AVE	MEAS	MAX	AVE	MEAS	MAX	AVE	MEAS	MAX	AVE	MEAS	
15 mph	1495	13.3	2.7	138	41	36	0.85	0.13	0.02	1148	399	774	PASS			
25 mph	2467	13.9	1.4	113	29	10	0.65	0.11	0.00	978	332	1112	FAIL			

MAX = Maximum Allowable Emissions

AVE = Average Emissions For Passing Vehicles

MEAS = Amount Measured

Failed smog check? Financial assistance may be available. To get an application, visit the Bureau of Automotive Repair's website at www.smogcheck.ca.gov or call toll-free at 800.952.5210.

Si usted ha fallado el examen de smog, asistencia financiera puede estar disponible.

Para obtener una solicitud, visite www.smogcheck.ca.gov o llamenos a BAR al 800.952.5210.

Smog Check Inspection Station Information

A+ Test Only Smog Service
6811 Redwood Dr. Ste. B Cotati, CA 94931
(707) 792-1512
Station Number: TB237679

Technician Name/Number: BLACKWELL, GARY/EA086938
Repair Tech Name/Number:
Software Version/EIS Number: 0403/ES819075

I certify, under penalty of perjury, under the laws of the State of California, that I performed the inspection in accordance with all bureau requirements, and that the information listed on this vehicle inspection report is true and accurate.

12-3-08
Date

Technician's Signature

Smog Check Vehicle Inspection Report (VIR)

Vehicle Information

Test Date/Time: 11/10/2008 @ 14:52

Model Year: 1986	Make: PORSCHE	Model: 911 CARRERA
License: 1PCY741	State: CA	VIN: WPOAB0916GS120538
Engine Size: 3.2 L	Type: Passenger	Transmission: Manual
GVWR: N/A	Test Weight: 3000	Cylinders: 6
Odometer: 202525	Certification: California	VLT Record #: 09008
Fuel Type: Gasoline	Exhaust: Single	Inspection Reason: High Emitter Profile

Overall Test Results

Comprehensive Visual Inspection: **PASS** Functional Check: **PASS** Emissions Test: **FAIL**

Repairing your vehicle is necessary to help California reduce smog-forming emissions and reach our air quality goals.

Emission Control Systems Visual Inspection/Functional Check Results

(Visual/Functional tests are used to assist in the identification of crankcase and cold start emissions which are not measured during the ASM test)

Result	ECS	Result	ECS	Result	ECS
Pass	PCV	N/A	Thermostatic Air Cleaner	Pass	Fuel Evaporative Controls
Pass	Catalytic Converter	N/A	Air Injection	N/A	MIL/Check Engine Light
N/A	EGR Visual	Pass	Vacuum Lines to Sensors/ Switches	Pass	Carb./Fuel Injection
N/A	EGR Functional	N/A	Ignition Timing:	Pass	Other Emission Related Components
Pass	Fuel Cap Functional	Pass	Wiring to Sensors	Pass	Oxygen Sensor
Pass	Fuel Cap Visual	N/A	Fillpipe Restrictor	Pass	Liquid Fuel Leaks
Pass	Spark Controls				
N/A	Fuel Evaporative Controls Functional				

ASM Emission Test Results

Test	RPM	%CO ₂		HC (PPM)			CO (%)			NO (PPM)			Results
		MEAS	MEAS	MAX	AVE	MEAS	MAX	AVE	MEAS	MAX	AVE	MEAS	
15 mph	1442	13.9	1.6	138	41	15	0.85	0.13	0.01	1148	399	1109	PASS
25 mph	2455	13.9	1.5	113	29	8	0.65	0.11	0.00	978	332	1151	FAIL

MAX = Maximum Allowable Emissions

AVE = Average Emissions For Passing Vehicles

MEAS = Amount Measured

Failed smog check? Financial assistance may be available. To get an application, visit the Bureau of Automotive Repair's website at www.smogcheck.ca.gov or call toll-free at 800.952.5210.

Si usted ha fallado el examen de smog, asistencia financiera puede estar disponible.

Para obtener una solicitud, visite www.smogcheck.ca.gov o llámenos a BAR al 800.952.5210.

Smog Check Inspection Station Information

A+ Test Only Smog Service
6811 Redwood Dr. Ste. B Cotati, CA 94931
(707) 792-1512
Station Number: TB237679

Technician Name/Number: KARAVOLOS, JOHN/EA073973
Repair Tech Name/Number:
Software Version/EIS Number: 0403/ES819075

I certify, under penalty of perjury, under the laws of the State of California, that I performed the inspection in accordance with all bureau requirements, and that the information listed on this vehicle inspection report is true and accurate.

11-10-08

Date

Technician's Signature

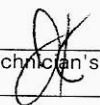

Date: 3/15/2004 03:38 PM
 Estimate ID: 3841
 Estimate Version: 0
 Preliminary
 Profile ID: STATE FARM

ANDERSON'S AUTO BODY, INC.

825 PETALUMA BOULEVARD N. PETALUMA, CA 94952
 (707) 762-4797
 Fax: (707) 762-4908
 Tax ID: 68-0375605

Damage Assessed By: EMIEL ANDERSON

Deductible: UNKNOWN

Insured: D
 Telephone: Home Phone: (

Mitchell Service: 912313

Description: 1986 Porsche 911 Carrera
 Body Style: 2D Cpe
 VIN: WPOAB0916GS120538
 OEM/ALT: O

Drive Train: 3.2L Inj 6 Cyl 5M

Search Code: B94952

ALL CRASH PARTS ON THIS ESTIMATE ARE "NEW" ORIGINAL EQUIPMENT MANUFACTURER PARTS, UNLESS OTHERWISE SPECIFIED. PARTS DESCRIBED AS RECHROMED RECORDED, REMANUFACTURED OR, RECONDITIONED ARE CONSIDERED "REBUILT" PARTS. CRASH PARTS DESCRIBED AS QUALITY REPLACEMENT PART ARE NON-ORIGINAL EQUIPMENT MANUFACTURER AFTERMARKET NEW PARTS.

Line Item	Entry Number	Labor Type	Operation	Line Item Description	Part Type/ Part Number	Dollar Amount	Labor Units
1	218180	REF	REFINISH	R QUARTER PANEL OUTSIDE			
2	218190	REF	BLEND	L QUARTER PANEL OUTSIDE			C 2.2 #
3	220320	GLS	REMOVE/INSTALL	R QTR GLASS STATIONARY	Existing		C 0.9 #
4	220330	GLS	REMOVE/INSTALL	L QTR GLASS STATIONARY	Existing		1.5*
5	220790	BDY	REPAIR	ENGINE LID PANEL	Existing		1.5*
6	AUTO	REF	REFINISH	ENGINE LID	Existing		5.0*
7	220810	BDY	REMOVE/INSTALL	ENGINE LID GRILLE	Existing		C 1.3
8	226160	BDY	REMOVE/INSTALL	R COMBINATION LAMP HOUSING	Existing		0.5*
9	226170	BDY	REMOVE/INSTALL	L COMBINATION LAMP HOUSING	Existing		0.5*
10	AUTO	REF	ADD'L OPR	CLEAR COAT	Existing		0.5*
11	933003	REF	ADD'L OPR	TINT COLOR			1.3
12	933018	REF	ADD'L OPR	MASK FOR OVERSPRAY			0.5*
13	AUTO		ADD'L COST	PAINT/MATERIALS		3.00 *	
						173.60 *	

* - Judgement Item
 # - Labor Note Applies
 C - Included in Clear Coat Calc

ESTIMATE RECALL NUMBER: 3/15/2004 15:38:05 3841

Mitchell Data Version: MAR_04_A
 UltraMate Version: 5.0.021

UltraMate is a Trademark of Mitchell International
 Copyright (C) 1994 - 2003 Mitchell International
 All Rights Reserved

I. Labor Subtotals	Units	Rate	Add'l Labor Amount	Sublet Amount	Totals	II. Part Replacement Summary	Amount	
Body	6.5	72.00	0.00	0.00	468.00			
Refinish	6.2	72.00	3.00	0.00	449.40	Total Replacement Parts Amount	0.00	
Glass	3.0	72.00	0.00	0.00	216.00			
Non-Taxable Labor					1,133.40			
Labor Summary	15.7				1,133.40			
III. Additional Costs					Amount	IV. Adjustments	Amount	
Taxable Costs					173.60	Customer Responsibility	0.00	
Sales Tax			@ 7.500%		13.02			
Total Additional Costs					186.62			
							I. Total Labor:	1,133.40
							II. Total Replacement Parts:	0.00
							III. Total Additional Costs:	186.62
							Gross Total:	1,320.02
							IV. Total Adjustments:	0.00
							Net Total:	1,320.02

This is a preliminary estimate.
Additional changes to the estimate may be required for the actual repair.

ANDERSONS AUTO BODY INC. WARRANTS ALL REPAIRS INCLUDING REFINISHING FOR THE LIFE OF THE VEHICLE. AFTER 1 YEAR THERE ARE LIMITS TO THIS WARRANTY. FOR MORE INFORMATION PLEASE REQUEST A COPY OF OUR WRITTEN WARRANTY.

I AUTHORIZE THE ABOVE REPAIRS.

SIGNED: _____ DATE: _____

I on 28th

DAMAGE REPORT
Date: 10/16/96
AJ134971

BROWN
D.R. 00004234
Estimator: SA

ANDERSON'S AUTO BODY
EXCELLENCE IN AUTO BODY REPAIR
825 PETALUMA BLVD. N.
PETALUMA, CA 94952-
(707) 762-4797

VEHICLE OWNER: I

DAY PHONE: (707)

ADDRESS: , 52

OTHER PHONE: (707)

YEAR: 86
STYLE:
VIN:

MAKE: PORSCHE
COLOR:
PROD DATE: /

MODEL:
LICENSE:
MILEAGE: 0

INSURANCE CO.:
ADJUSTER:

CLAIM NO.:

PHONE: - - -

DED.: 0.00

NO.	REPLACE REPAIR	DESCRIPTION OF DAMAGE	QTY	PARTS PRICE	LBR HRS	PAINT HRS	MISC
1	Repair	ROOF	1	0.00	4.0	3.5	
2	Replace	SEAL SUN ROOF FRONT	1	43.98	0.5	0.0	
3	Replace	SEAL SUN ROOF REAR	1	13.98	0.5	0.0	
4		R&I TRIM FENDER LT	1	0.00	0.5	0.0	
5	Repair	LT FENDER	1	0.00	2.0	2.0	
6		COLOR MATCH	1	0.00	0.0	0.5	
7		CLEAR COAT	1	0.00	0.0	2.0	
Subtotals ==>				57.96	7.3	8.0	0.00

Paul [Signature] 10/31/96

Parts (Subject to Invoice)	57.96
Labor 7.3 hrs @ 52.00/hr	379.60
Paint 8.0 hrs @ 52.00/hr	416.00
Paint Supplies	192.00
Subtotal	\$ 1045.56
Tax on \$ 57.96 @ 7.5000%	4.35

GRAND TOTAL \$ ~~1045.91~~

If you pay CASH yourself discount 40 \$ 800.00

I hereby authorize the above repair work to be done along with the necessary materials. You and your employees may operate the above vehicle for purposes of testing, inspection or delivery at my risk. An express mechanics lien is acknowledged on the above vehicle to secure the amount of repairs thereto.

SIGNED x _____

DEPENDABLE TIRE & BRAKE

Phone (415) 456-2311
Fax (415) 456-8740

25 Market Street
San Rafael, CA 94901

BAR# AG126629
EPA# CAL 000 012 611

INVOICE PENDING PAYMENT

368
SEBASTOPOL, CA 95472-
HOME PHONE
86/PORSCHE 911 IPCV741 CA BLUE
V.I.N. NUMBER

INVOICE NUMBER 1029415
DECEMBER 04, 2006 11:39
WORK PHONE (707)
P/T: 12/04/06 @ 17:00 ENGINE
MILEAGE 185,679

PART NO.	DESCRIPTION	PRICE
2 42080	205/55R16 MICH PLT SP	310.00
2 87425	225/50R16 MICH PLT SP	334.00
4 STEMS	STD VALVE STEM	.00

CODE	LABOR OPERATION	PRICE
024	BALANCE 4 ALLOY WHEELS 4 NEW TIRES	60.00
	RET	7.00
	TIRE DISPOSAL FEE	11.00
024	4 WHEEL ALIGNMENT FRONT AND REAR WHEEL ALIGNMENT	130.00



CELL # BEEPER OTHER

I HEREBY AUTHORIZE THE ABOVE REPAIR WORK TO BE DONE ALONG WITH THE NECESSARY MATERIAL AND HEREBY GRANT YOU AND/OR YOUR EMPLOYEES PERMISSION TO OPERATE THE VEHICLE HEREIN DESCRIBED ON STREETS, HIGHWAYS OR ELSEWHERE FOR THE PURPOSE OF TESTING AND/OR INSPECTION. AN EXPRESS MECHANIC'S LIEN IS HEREBY ACKNOWLEDGED ON ABOVE VEHICLE TO SECURE THE AMOUNT OF REPAIRS THERETO. I UNDERSTAND THAT THIS REPAIR FACILITY IS NOT AN INSURER OF SAID VEHICLE AND WILL NOT BE HELD RESPONSIBLE FOR LOSS OR DAMAGE TO VEHICLE OR ARTICLES LEFT IN VEHICLE IN CASE OF FIRE, THEFT, ACCIDENT OR ANY OTHER CAUSE BEYOND YOUR CONTROL. A STORAGE FEE OF \$10.00 PER DAY WILL BE ADDED TO REPAIR BILL IF VEHICLE IS NOT PICKED UP WITHIN THREE (3) WORKING DAYS OF COMPLETION OF WORK.

AUTHORIZED BY X *[Signature]*

ORIGINAL ESTIMATE 946.78

I ACKNOWLEDGE NOTICE AND ORAL APPROVAL OF AN INCREASE IN THE ORIGINAL ESTIMATED PRICE.

(SIGNATURE OR INITIALS)

RECOMMENDED SERVICES / FUTURE VEHICLE NEEDS

BRAKES REMAINING 35% FRONT AND REAR APPROX 12/4/06
1 WHEEL STUD AT RIGHT FRONT HAS CHEWED THREADS 12/4/06
RIGHT SIDE OF CAR 1/2" HIGH. RECOMEND CORNER BALANCE, RE-ALIGN
TOE ADJUSTER AT RIGHT REAR MAXED OUT. THRUST ANGLE SLIGHTLY OFF.
12/4/06

VISA .00
M/C .00
AM. EXP .00
DISCVR .00
OTHER .00
CHECK .00
CASH .00
NAPA .00
SH/WTY .00
O. C-C .00
ATM .00
AM PD .00

TOTALS
PARTS 664.00
SUBLET 18.00
LABOR 210.00
EQ/HW .00
SUB TOTAL 892.00
TAX 54.78
TOTAL 946.78

CUSTOMER COPY

Road Test

NOTIFIED

PROMISED

Phone when ready
Yes NO

DISCARD PARTS C = REFUNDABLE CORE DEPOSIT

REBUILT U = USED

SAVE PARTS N = NEW

**Dependable Tire
25 Market Street
San Rafael, Ca. 94901
415-456-2311**

Work Order ID R003311
Customer Number 3313
Name
License 1PCY741
Technician NICH
Mileage 185679
Time Printed 11/30/06 6:21 AM

Porsche : 911 : 1970-89 : except USA/Japan/Canada, Turbo-Look Models

Left Front

Actual	Before	Specified Range	
-0.4°	-0.3°	-0.2°	0.2°
5.7°	5.7°	5.8°	6.3°
0.13°	-0.99°	0.08°	0.17°
.....
.....
.....	-0.83°	0.00°

Right Front

Actual	Before	Specified Range	
-0.8°	-0.7°	-0.2°	0.2°
6.4°	6.4°	5.8°	6.3°
0.10°	-1.10°	0.08°	0.17°
.....
.....
.....	-0.83°	0.00°

Camber
Caster
Toe
SAI
Included Angle
Turning Angle Diff.

Front

	Actual	Before	Specified Range	
Cross Camber	0.4°	0.4°	-0.2°	0.2°
Cross Caster	-0.7°	-0.7°	-0.5°	0.5°
Cross SAI
Total Toe	0.23°	-2.09°	0.17°	0.33°
Cross Turn Diff.

Left Rear

Actual	Before	Specified Range	
-0.9°	-0.9°	-1.2°	-0.8°
0.08°	0.06°	0.00°	0.33°

Right Rear

Actual	Before	Specified Range	
-0.9°	-1.4°	-1.2°	-0.8°
0.24°	0.15°	0.00°	0.33°

Rear

	Actual	Before	Specified Range	
Cross Camber	0.0°	0.5°	-0.3°	0.3°
Total Toe	0.32°	0.21°	0.00°	0.67°
Thrust Angle	-0.08°	-0.04°	-0.17°	0.17°

Scanzo - 485-6026

REPAIR ORDER

deJung Motorsport
 459 Portal St. Suite A
 Cotati, CA 94931
 (707) 664-8002
 BAR #ARD 101025
 EPA# CAL000064429

R/O # : 13222
 Name :
 Date : 03/27/2009
 License # : 1PCY741
 Make : PORSCHE
 Model : CARRERA
 Year : 86
 Mileage : 205799 Save Parts : NO
 VIN : WPOAB0916GS120538

, CA

LABOR

	AMOUNT
Change engine oil and filter.	
Check transaxle oil level.	100.00
Inspect brakes.	
Check tire pressures.	
Check lights.	
Check brake fluid level.	

PARTS	All parts new unless stated used or remanufactured	PRICE	QTY	AMOUNT
OC 54	OIL FILTER	16.74	1	16.74
15	**CASTROL OIL(PTS.)	2.45	22	53.90
4602227	COPPER WASHER	.80	2	1.60
01	TECHRON	8.46	1	8.46

Original Estimate : 195.15

Increases to Estimate					
Date	Time	OK'd By	Phone	Emp.	Increase

LABOR	100.00
PARTS	80.70
SUBLETS	.00
	.00
HAZARDOUS MATERIALS	8.20
SUB TOTAL	188.90
TAX	6.25
TOTAL	<u>195.15</u>

Parts & labor conditionally guaranteed 4,000 mi./ 90 days.

I hereby authorize DEJUNG MOTORSPORT to perform the repair work listed above along with necessary materials. You and your employees may operate the above vehicle for purposes of testing, inspection, or delivery at my risk. An express mechanics lien is acknowledged on above vehicle to secure the amount of repairs. Thereto it is understood that this company assumes no responsibility for loss or damage by theft or fire to vehicles placed with them for storage, sale, repair, or while road testing.

Authorized by : _____ Date : _____

REPAIR ORDER

deJung Motorsport
459 Portal St. Suite A
Cotati, CA 94931
(707) 664-8002
BAR #ARD 101025
EPA# CAL000064429

R/O # : 13146
Name : J
Date : 01/30/2009
License # : 1PCY741
Make : PORSCHE
Model : CARRERA
Year : 86
Mileage : 204482 Save Parts : NO
VIN : WPOAB0916GS120538

CA

LABOR

	AMOUNT
Check out non op door locks.	
R&I the drivers door panel.	.00
Found corrosion in both plugs at:	
1. door lock actuator	
2. door handle micro switch.	
Clean out the corrosion.	
This above did not correct the non op door lock issue	
Further wiring tests show that the actuator is defective.	
R&R the indide rear view mirror.	.00
Check for noise (2500-3500 RPM)	
Ticking?	.00
L/R Rotational?	
Under load (accelerating) not when crusing.	
Going on for about 6 weeks, possibly louder now then when first started.	
The cap for the test port for measuring the exhaust content has fallen off.	
Install a new cap.	
1/30/09	
ALL ABOVE TIME 1 HOUR 50 MINUTES.	160.00
DEDUCT 15 MINUTES FOR NOISE CORRECTION FROM ABOVE.	
CHARGE 1 HOUR 35 MINUTES.	
2/6/09	
R&I left door panel.	150.00
R&R left door lock actuator.	
Solder in 5 wires to extend the door lock actuator, wiring loom.	
Shrink tube all solder connections.	

PARTS	All parts new unless stated used or remanufactured	PRICE	QTY	AMOUNT
477 857 511A	MIRROR-INTERIOR	80.97	1	80.97
928 624 211 00	LOCK ACTUATOR	102.83	1	102.83

REPAIR ORDER

deJung Motorsport
 459 Portal St. Suite A
 Cotati, CA 94931
 (707) 664-8002
 BAR #ARD 101025
 EPA# CAL000064429

R/O # : 13061
 Name : E
 Date : 11/14/2008
 License # : 1PCY741
 Make : PORSCHE
 Model : CARRERA
 Year : 86
 Mileage : 203072 Save Parts : NO
 VIN : WPOAB0916GS120538

, CA

LABOR

	AMOUNT
ROA \$750.00 - 11/13/08	.00
R&R catalytic converter. Install an oxygen sensor port in the new catalytic converter.	210.00

PARTS

All parts new unless stated used or remanufactured

		PRICE	QTY	AMOUNT
	CATALYTIC CONVERTER	750.00	1	750.00
KNF 85-21688	BUSHING	15.49	1	15.49
930 111 193 07	EXHAUST GASKET	18.18	1	18.18
930 111 192 06	GASKET-HEAT EXCHANGER	13.21	1	13.21
911 111 191 01	GASKET	8.84	1	8.84
0570840	BOLT	.60	9	5.40
3662	COPPER NUT	.36	9	3.24
01	TECHRON	8.46	1	8.46

SUBLETS

	AMOUNT
Freight	40.00
Inspection	48.00

RECOMMENDATIONS AND TECHNICIANS NOTES

Headlamp flashers do not work.

Original Estimate : 1,184.59

Increases to Estimate					
Date	Time	OK'd By	Phone	Emp.	Increase

LABOR	210.00
PARTS	822.82
SUBLETS	88.00
	.00
SUB TOTAL	1,120.82
TAX	63.77
TOTAL	<u>1,184.59</u>

Parts & labor conditionally guaranteed 4,000 mi./ 90 days.

I hereby authorize DEJUNG MOTORSPORT to perform the repair work listed above along with necessary materials. You and your employees may operate the above vehicle for purposes of testing, inspection, or delivery at my risk. An express mechanics lien is acknowledged on above vehicle to secure the amount of repairs. Thereto it is understood that this company assumes no responsibility for loss or damage by theft or fire to vehicles placed with them for storage, sale, repair, or while road testing.

Authorized by : _____ Date : _____

REPAIR ORDER

deJung Motorsport
 459 Portal St. Suite A
 Cotati, CA 94931
 (707) 664-8002
 BAR #ARD 101025
 EPA# CAL000064429

R/O # : 12971
 Name :
 Date : 09/02/2008
 License # : 1PCY741
 Make : PORSCHE
 Model : CARRERA
 Year : 86
 Mileage : 200514 Save Parts : NO
 VIN : WPOAB0916GS120538

. CA

LABOR

Change engine oil and filter.
 Check transaxle oil level.
 Inspect brakes.
 Check tire pressures.
 Check lights.
 Check brake fluid level.

AMOUNT
100.00

PARTS All parts new unless stated used or remanufactured

		PRICE	QTY	AMOUNT
OC 54	OIL FILTER	16.28	1	16.28
10	**ENGINE OIL(PTS.)	1.60	22	35.20
4602227	COPPER WASHER	.80	2	1.60
01	TECHRON	8.46	1	8.46
03	WASHER SOLVENT	3.50	1	3.50
	15 AMP FUSE	.20	1	.20

RECOMMENDATIONS AND TECHNICIANS NOTES

Headlamp flashers do not work.

Original Estimate : 178.50

Increases to Estimate						
Date	Time	OK'd By	Phone	Emp.		Increase

Parts & labor conditionally guaranteed 4,000 mi./90 days.

LABOR	100.00
PARTS	65.24
SUBLETS	.00
	.00
HAZARDOUS MATERIALS	8.20
SUB TOTAL	173.44
TAX	5.06
TOTAL	<u>178.50</u>

I hereby authorize DEJUNG MOTORSPORT to perform the repair work listed above along with necessary materials. You and your employees may operate the above vehicle for purposes of testing, inspection, or delivery at my risk. An express mechanics lien is acknowledged on above vehicle to secure the amount of repairs. Thereto it is understood that this company assumes no responsibility for loss or damage by theft or fire to vehicles placed with them for storage, sale, repair, or while road testing.

Authorized by : _____ Date : _____

REPAIR ORDER

deJung Motorsport
 459 Portal St. Suite A
 Cotati, CA 94931
 (707) 664-8002
 BAR #:A.C. 101025
 EPA# CAL000064429

R/O # : 12378
 Name :
 Date : 06/22/2007
 License # : 1PCY741
 Make : PORSCHE
 Model : CARRERA
 Year : 86
 Mileage : 190031 Save Parts : NO
 VIN : WPOAB0916GS120538

CA

LABOR

	AMOUNT
Change engine oil and filter.	100.00
Check transaxle oil level.	
Inspect brakes.	
Check tire pressures.	
Check lights.	
Check brake fluid level.	
Inspect AC system for leaks. None found.	100.00
Charge AC system.	
Temps before charge:	
Left vent, 80'---center vent, 87'	
Temps after charge:	
Left vent, 53'---center vent, 53'	
Replace the left jack position, fill plug.	.00

PARTS	All parts new unless stated used or remanufactured	PRICE	QTY	AMOUNT
OC 54	OIL FILTER	14.64	1	14.64
10	**ENGINE OIL(PTS.)	1.60	22	35.20
4602227	COPPER WASHER	.60	2	1.20
01	TECHRON	7.50	1	7.50
03	WASHER SOLVENT	3.50	1	3.50
R-12	FREON P/OZ	3.50	29	101.50
911 559 149 01	PLUG	4.20	1	4.20

Original Estimate : 389.38

Increases to Estimate					
Date	Time	OK'd By	Phone	Emp.	Increase

LABOR	200.00
PARTS	167.74
SUBLETS	.00
	.00
HAZARDOUS MATERIALS	8.64
SUB TOTAL	376.38
TAX	13.00
TOTAL	389.38

Parts & labor conditionally guaranteed 4,000 mi./ 90 days.

I hereby authorize DEJUNG MOTORSPORT to perform the repair work listed above along with necessary materials. You and your employees may operate the above vehicle for purposes of testing, inspection, or delivery at my risk. An express mechanics lien is acknowledged on above vehicle to secure the amount of repairs. Thereto it is understood that this company assumes no responsibility for loss or damage by theft or fire to vehicles placed with them for storage, sale, repair, or while road testing.

Authorized by : _____ Date : _____

REPAIR ORDER

deJung Motorsport
 459 Portal St. Suite A
 Cotati, CA 94931
 (707) 664-8002
 BAR #:A.C. 101025
 EPA# CAL000064429

R/O # : 12082
 Name :
 Date : 11/28/2006
 License # : 1PCY741
 Make : PORSCHE
 Model : CARRERA
 Year : 86
 Mileage : 185575 Save Parts : NO
 VIN : WPOAB0916GS120538

, CA

LABOR

	AMOUNT
R&I front wheel hubs.	180.00
Clean, inspect and repack front wheel bearings.	
R&R steering rack.	270.00
Install TURBO tie rod assemblies.	
Front end needs to be aligned	

PARTS All parts new unless stated used or remanufactured

	PRICE	QTY	AMOUNT
914 347 010 06 STEERING RACK	517.42	1	517.42
930 347 031 01 TIE ROD ASSEMBLY	85.00	2	170.00
930 347 191 02 RACK BOOT	9.38	2	18.76
930 347 313 01 TIE ROD SPACER	10.42	2	20.84
477 405 641 OIL SEAL	10.37	2	20.74

4/2.5 mi
 22.4/MPG

Original Estimate : 1,255.71

Increases to Estimate					
Date	Time	OK'd By	Phone	Emp.	Incre

Parts & labor conditionally guaranteed 4,000 mi./ 90 days.

LABOR	450.00
PARTS	747.76
DUPLICATES	.00
	.00
B TOTAL	1,197.76
TAX	57.95
TOTAL	<u>1,255.71</u>

I hereby authorize DEJUNG MOTORSPORT to perform the repair work listed above along with necessary materials. You and your employees may operate the above vehicle for purposes of testing, inspection, or delivery at my risk. An express mechanics lien is acknowledged on above vehicle to secure the amount of repairs. Thereto it is understood that this company assumes no responsibility for loss or damage by theft or fire to vehicles placed with them for storage, sale, repair, or while road testing.

Authorized by : _____ Date : _____

REPAIR ORDER

deJung Motorsport
 459 Portal St. Suite A
 Cotati, CA 94931
 (707) 664-8002
 BAR #:A.C. 101025
 EPA# CAL000064429

R/O # : 12072
 Name :
 Date : 11/17/2006
 License # : 1PCY741
 Make : PORSCHE
 Model : CARRERA
 Year : 86
 Mileage : 185301 Save Parts : NO
 VIN : WPOAB0916GS120538

. CA

LABOR

	AMOUNT
Change engine oil and filter.	
Check transaxle oil level.	90.00
Inspect brakes.	
Check tire pressures.	
Check lights.	
Check brake fluid level.	
R&R passenger window switch at the left door.	.00

PARTS	All parts new unless stated used or remanufactured	PRICE	QTY	AMOUNT
OC 54	OIL FILTER	14.64	1	14.64
10	**ENGINE OIL(PTS.)	1.50	22	33.00
4602227	COPPER WASHER	.60	2	1.20
01	TECHRON	7.50	1	7.50
03	WASHER SOLVENT	3.50	1	3.50
911 613 621 03	WINDOW SWITCH	20.11	1	20.11

SUBLETS	AMOUNT
Inspection.	68.00

RECOMMENDATIONS AND TECHNICIANS NOTES

Repack front wheel bearings.
 Front tires are at the wear bars.
 Rear tires are just off the wear bars.
 Steering rack is worn.

Original Estimate : 252.79

Increases to Estimate					
Date	Time	OK'd By	Phone	Emp.	Increase

LABOR	90.00
PARTS	79.95
SUBLETS	68.00
	.00
HAZARDOUS MATERIALS	8.64
SUB TOTAL	246.59
TAX	6.20
TOTAL	252.79

Parts & labor conditionally guaranteed 4,000 mi./ 90 days.

I hereby authorize DEJUNG MOTORSPORT to perform the repair work listed above along with necessary materials. You and your employees may operate the above vehicle for purposes of testing, inspection, or delivery at my risk. An express mechanics lien is acknowledged on above vehicle to secure the amount of repairs. Thereto it is understood that this company assumes no responsibility for loss or damage by theft or fire to vehicles placed with them for storage, sale, repair, or while road testing.

Authorized by : _____ Date : _____



A+ TEST ONLY SMOG SERVICE OF COTATI

6811 Redwood Dr. Ste. B • Cotati, CA 94931

Phone (707) 792-1512

BAR No AB237679

#24623

No 10274

SMOG TEST-ONLY INVOICE

NAME	TODAY'S DATE	YEAR	MAKE	MODEL
	11.17.06	86	Porsche	Carrera
ADDRESS	ODOMETER	LIC. PLATE #	MOTOR #	
P.O. Box	185302	1PCY7411		
CITY, STATE ZIP	WRITTEN BY	CUSTOMER P.O. #	G.V.W.R.	
HOME PHONE	TEST TYPE:		2% HEP INITIAL	
() ()	<input type="checkbox"/> BIENNIAL <input type="checkbox"/> CHANGE OF OWNERSHIP		<input type="checkbox"/> 2% <input type="checkbox"/> HEP <input type="checkbox"/> INITIAL	
METHOD OF PAYMENT:	<input type="checkbox"/> FED. <input checked="" type="checkbox"/> CALIF. <input type="checkbox"/> O/S		ENGINE 3.2 # OF CYLINDERS 6	
<input type="checkbox"/> CASH <input checked="" type="checkbox"/> CHECK <input type="checkbox"/> CREDIT CARD	TRANSMISSION: <input type="checkbox"/> AUTO <input checked="" type="checkbox"/> STD		TIMING 70 EM. LIGHT	
<input type="checkbox"/> CHARGE <input type="checkbox"/> DEBIT CARD	ORIGINAL ESTIMATE \$		V.I.N.	

SMOG TEST CHECK OFF

	P-Pass	M-Modified	F-Defective	D-Disconnected	S-Missing	N-N/A
PCV	P			CDP		
TAC				AP/P		
EVP	P			OXY		
CAT	P			WRG		
EGR				VAC		
SPK	P			OTH		

Asan/Pas

OPR.	DESCRIPTION OF WORK	AMOUNT
	SMOG TEST	79.75
	PRETEST <input type="checkbox"/> YES <input type="checkbox"/> NO	
	CERTIFICATE #	825
	ELECTRONIC TRANSFER FEE (E.T.F.)	
	RETEST	
	GAS CAP	
	113.00	20.00

TEST RESULTS: PASS FAIL ABORT

THIS SMOG TEST-ONLY STATION CANNOT PERFORM ANY DIAGNOSTICS, ADJUSTMENTS OR REPAIRS

I hereby authorize the above smog test to be performed. Smog test fee is due whether above vehicle passes or fails the smog test. You and your employees may operate above vehicle for purposes of testing, inspection and delivery at my risk. An express mechanic's lien is acknowledged on above vehicle to secure the amount of this invoice. You will not be held responsible for loss or damage to vehicle due to fire, theft, accident, dynamometer testing or any other cause beyond your control. In the event legal action is necessary to enforce this contract, I understand that I am solely responsible for all costs including attorney's fees and court costs. I have read and understand the above and acknowledge receipt of an estimate.

X _____ DATE: _____

REVISSED ESTIMATE \$ _____ DATE _____ TIME _____ PHONE • FAX • EMAIL _____

REASON _____

PHONE EMAIL IN PERSON FAX

ADDITIONAL COST \$ _____

I acknowledge notice and oral approval of an increase in the original estimated price.

X

TOTAL WORK		
CERTIFICATE		
E.T.F.		
SUB TOTAL		
SALES TAX		
GRAND TOTAL	108.00	

Smog Check Vehicle Inspection Report (VIR)

Vehicle Information

Test Date/Time: 11/17/2006 @ 15:40

Model Year: 1986	Make: PORSCHE	Model: 911 CARRERA
License: 1PCY741	State: CA	VIN: WPOAB0916GS120538
Engine Size: 3.2 L	Type: Passenger	Transmission: Manual
GVWR: N/A	Test Weight: 3000	Cylinders: 6
Odometer: 185302	Certification: California	VLT Record #: 09008
Fuel Type: Gasoline	Exhaust: Single	Inspection Reason: High Emitter Profile

Overall Test Results

Congratulations! Your vehicle passed the enhanced Smog Check inspection, which helps California reach its daily goal of removing an extra 100 tons of smog-forming emissions from the air. Thank you for keeping your vehicle well maintained.

Smog Check Certificate Number: MM837583
DMV ID Number: **3477M059M758**

Your Smog Check certificate has been electronically transmitted to DMV.
Your certificate is valid for 90 days from date of issuance.
Please keep this copy for your records.

Emission Control Systems Visual Inspection/Functional Check Results

(Visual/Functional tests are used to assist in the identification of crankcase and cold start emissions which are not measured during the ASM test)

Result	ECS	Result	ECS	Result	ECS
Pass	PCV	N/A	Thermostatic Air Cleaner	Pass	Fuel Evaporative Controls
Pass	Catalytic Converter	N/A	Air Injection	N/A	MIL/Check Engine Light
N/A	EGR Visual	Pass	Vacuum Lines to Sensors/ Switches	Pass	Carb./Fuel Injection
N/A	EGR Functional	N/A	Ignition Timing:	Pass	Other Emission Related Components
Pass	Fuel Cap Functional	Pass	Wiring to Sensors	Pass	Oxygen Sensor
Pass	Fuel Cap Visual	N/A	Fillpipe Restrictor	Pass	Liquid Fuel Leaks
Pass	Spark Controls				
N/A	Fuel Evaporative Controls Functional				

ASM Emission Test Results

Test	RPM	%CO ₂		%O ₂			HC (PPM)			CO (%)			NO (PPM)			Results
		MEAS	MEAS	MAX	AVE	MEAS	MAX	AVE	MEAS	MAX	AVE	MEAS				
15 mph	1495	14.3	1.1	138	41	19	0.85	0.13	0.07	1148	399	933	PASS			
25 mph	2443	14.2	1.1	113	29	9	0.65	0.11	0.01	978	332	975	PASS			

MAX = Maximum Allowable Emissions

AVE = Average Emissions For Passing Vehicles

MEAS = Amount Measured

Smog Check Inspection Station Information

A+ Test Only Smog Service
6811 Redwood Dr. Ste. B Cotati, CA 94931
(707) 792-1512
Station Number: TB237679

Technician Name/Number: BLACKWELL GARY L JR/EA086938
Repair Tech Name/Number:
Software Version/EIS Number: 0403/ES819075

I certify, under penalty of perjury, under the laws of the State of California, that I performed the inspection in accordance with all bureau requirements, and that the information listed on this vehicle inspection report is true and accurate.

11.17.06
Date

[Signature]
Technician's Signature

A+ TEST ONLY SMOG SERVICE OF COTATI



6811 Redwood Drive Ste B
COTATI, CA 94931
(707) 792-1512
BAR# AB232240



NAME <i>[Signature]</i>		004763	
ADDRESS <i>P.O. Box 1521</i>			
CITY <i>Sebastopol</i>	PHONE <i>---</i>	DATE OF ORDER <i>12-10-04</i>	
CUSTOMER'S ORDER NO.	VIN NO.		
YEAR, MAKE AND MODEL <i>86 Porsche 911</i>	Retain Parts <input type="checkbox"/>	Destroy Parts <input type="checkbox"/>	ODOMETER <i>767,749</i>
ORDER WRITTEN BY <i>1PCY 741</i>	LICENSE NUMBER <i>1PCY 741</i>	DATE PROMISED	

* CODE N-NEW U-USED R-REBUILT		
QTY	PART NO. OR DESCRIPTION	SALE
	<i>322KAL N/A</i>	
TOTAL PARTS		

EMISSION CHECK OFF			
PCV	<i>P</i>	TWC	<i>P</i>
TAC	<i>---</i>	EGR	<i>---</i>
AIS	<i>---</i>	SPK	<i>P</i>
EVP	<i>P</i>	CCO	<i>P</i>
FR	<i>P</i>	INI	<i>P</i>
OC	<i>P</i>	<i>O2</i>	<i>P</i>

P-PASS		F-Fail	M-Modified	D-Disconnect	N-N/A
ORIGINAL ESTIMATE \$ <i>68.00</i>	AUTHORIZED BY				
PHONE #	DATE	TIME			
REVISED ESTIMATE \$	REASON	ADDITIONAL COST \$			
AUTHORIZED BY		<input type="checkbox"/> IN PERSON	DATE	TIME	
		<input type="checkbox"/> PHONE #			
I ACKNOWLEDGE NOTICE AND ORAL APPROVAL OF AN INCREASE IN THE ABOVE ESTIMATED PRICE.		CUST. SIGN <i>[Signature]</i>			

LABOR INSTRUCTIONS		AMOUNT
GROSS VECH. WEIGHT	/M SMOG INSPECTION	<i>79.75</i>
Cert. No. <i>FR 039875</i>	/M SMOG CERTIFICATE	<i>8.25</i>
<i>DIS - 20.00</i>		
<i>ASM / Passed</i>		
<input type="checkbox"/> CASH	<input type="checkbox"/> CHECK	<input checked="" type="checkbox"/> CHARGE
SOME EMISSION CONTROL DEVICES MAY STILL BE COVERED UNDER MFG.'S WARRANTY.		TOTAL LABOR <i>59.75</i>
BY LAW, YOU MAY CHOOSE ANOTHER LICENSED SMOG CHECK FACILITY TO PERFORM ANY NEEDED REPAIRS OR ADJUSTMENTS WHICH THE SMOG TEST INDICATES ARE NECESSARY.		CERTIFICATE <i>8.25</i>
I, the Registered Owner authorize you to perform the above repairs and furnish necessary materials. I understand any cost quoted heretofore is an estimate only. You and your employees may operate vehicle for inspection, testing, delivery at my risk. You will not be responsible for loss or damage to vehicle or articles left in it. I agree to pay reasonable storage on vehicle left more than 48 hrs. after notification that repairs are completed. An express mechanic's lien is acknowledged on above vehicle to secure the amount of repairs thereto, including those from any prior work or repair contract on this vehicle. In the event an attorney is retained to foreclose this lien or to bring suit for collection of any sum due I agree to pay costs of collection and reasonable attorney fees.		PARTS
I also understand that the Dealer is not a depository for personal property left in the vehicle and assumes no risk for loss thereof.		SUB TOTAL
RECEIPT OF A COPY OF THIS ORDER IS HEREBY ACKNOWLEDGED.		SALES TAX
SIGNATURE <i>[Signature]</i>		LABOR
		TOTAL AMOUNT <i>68.00</i>

SWO-643-4
PRINTED IN U.S.A.

INVOICE COPY

Smog Check Vehicle Inspection Report (VIR)

Vehicle Information

Test Date/Time: 12/10/2004 @ 13:15

Model Year: 1986	Make: PORSCHE	Model: 911 CARRERA
License: 1PCY741	State: CA	VIN: WPOAB0916GS120538
Engine Size: 3.2 L	Type: Passenger	Transmission: Manual
GVWR: N/A	Test Weight: 3000	Cylinders: 6
Odometer: 167749	Certification: California	VLT Record #: 09008
Fuel Type: Gasoline	Exhaust: Single	Inspection Reason: Change of Ownership

Overall Test Results

Congratulations! Your vehicle passed the enhanced Smog Check inspection, which helps California reach its daily goal of removing an extra 100 tons of smog-forming emissions from the air. Thank you for keeping your vehicle well maintained.

Smog Check Certificate Number: FR039875
DMV ID Number: **3270R059F458**

Your Smog Check certificate has been electronically transmitted to DMV.
Your certificate is valid for 90 days from date of issuance.
Please keep this copy for your records.

Emission Control Systems Visual Inspection/Functional Check Results

(Visual/Functional tests are used to assist in the identification of crankcase and cold start emissions which are not measured during the ASM test)

Result	ECS	Result	ECS	Result	ECS
Pass	PCV	N/A	Thermostatic Air Cleaner	Pass	Fuel Evaporative Controls
Pass	Catalytic Converter	N/A	Air Injection	N/A	MIL/Check Engine Light
N/A	EGR Visual	Pass	Vacuum Lines to Sensors/ Switches	Pass	Carb./Fuel Injection
N/A	EGR Functional		Ignition Timing:	Pass	Other Emission Related Components
Pass	Fuel Cap Functional	N/A	Wiring to Sensors	Pass	Oxygen Sensor
Pass	Fuel Cap Visual	Pass	Fillpipe Restrictor	Pass	Liquid Fuel Leaks
Pass	Spark Controls	N/A			
N/A	Fuel Evaporative Controls Functional				

ASM Emission Test Results

Test	RPM	%CO ₂		HC (PPM)			CO (%)			NO (PPM)			Results
		MEAS	MEAS	MAX	AVE	MEAS	MAX	AVE	MEAS	MAX	AVE	MEAS	
15 mph	1518	14.8	0.3	138	41	22	0.85	0.13	0.03	1148	399	671	PASS
25 mph	2379	14.6	0.5	113	29	15	0.65	0.11	0.01	978	332	972	PASS

MAX = Maximum Allowable Emissions

AVE = Average Emissions For Passing Vehicles

MEAS = Amount Measured

Smog Check Inspection Station Information

A + Test Only Smog Service
6811 Redwood Dr. Ste. B Cotati, CA 94931
(707) 792-1512
Station Number: TB232240

Technician Name/Number: MANNION PARRIS TYLER/EA148302
Repair Tech Name/Number:
Software Version/EIS Number: 0403/ES819075

I certify, under penalty of perjury, under the laws of the State of California, that I performed the inspection in accordance with all bureau requirements, and that the information listed on this vehicle inspection report is true and accurate.

12-10-04

Date

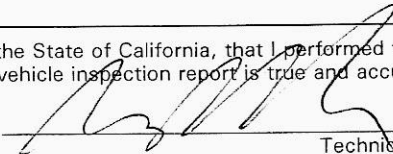

Technician's Signature

REPAIR ORDER

deJung Motorsport
 459 Portal St. Suite A
 Cotati, CA 94931
 (707) 664-8002
 BAR #: A.C. 101025
 EPA# CAL000064429

R/O # : 12772
 Name _____
 Date : 04/16/2008
 License # : 1PCY741
 Make : PORSCHE
 Model : CARRERA
 Year : 86
 Mileage : 196567 Save Parts : NO
 VIN : WPOAB0916GS120538

CA

LABOR	AMOUNT
Inspect for clutch release problem.	
The clutch arm spring is broken.	
The clutch operating lever is siezed on the release shaft.	
Free the clutch operating lever from the release shaft.	
R&R the clutch arm spring.	
Clean and lube the needle bearing in the release arm.	
Remove the rust from the clutch operating lever and release shaft.	
Lube the clutch operating lever and release shaft.	
Replace seals at the clutch operating lever to release shaft union.	
	150.00

PARTS	All parts new unless stated used or remanufactured	PRICE	QTY	AMOUNT
915 116 064 00	CLUTCH ARM SPRING	96.71	1	96.71
915 301 139 00	JOINT RING	2.20	2	4.40

Original Estimate : 258.95

Increases to Estimate						
Date	Time	OK'd By	Phone	Emp.	Increase	

LABOR	150.00
PARTS	101.11
SUBLETS	.00
	.00
SUB TOTAL	251.11
TAX	7.84
TOTAL	<u>258.95</u>

Parts & labor conditionally guaranteed 4,000 mi./ 90 days.

I hereby authorize DEJUNG MOTORSPORT to perform the repair work listed above along with necessary materials. You and your employees may operate the above vehicle for purposes of testing, inspection, or delivery at my risk. An express mechanics lien is acknowledged on above vehicle to secure the amount of repairs. Thereto it is understood that this company assumes no responsibility for loss or damage by theft or fire to vehicles placed with them for storage, sale, repair, or while road testing.

Authorized by : _____ Date : _____

Model	Year	MG	SG	Illustration	VIN No.	Update	17:11	16.04.2008	PORSCHE	PET	PORSCHE
911	85	3	01	301-05		125					

Pos	Part Number	Name	Remarks	Qty	Model
1	915 116 712 01	clutch release fork		1	CARRERA
1	930 116 712 02	fork		1	TURBO
2	915 116 133 05	shaft		1	CARRERA
2	930 116 133 04	shaft		1	TURBO
3	900 095 050 00	tension sleeve		1	
4	915 301 139 00	sealing ring		3	CARRERA
4	930 301 139 00	sealing ring		2	TURBO
4	930 301 140 00	sealing ring		2	TURBO
8	N 012 418 1	lock ring 18 X 1,2		1	
9	915 116 082 80	release bearing		1	CARRERA
9	930 116 081 10	release bearing		1	TURBO
9A	999 152 073 01	circlip SW 50		1	CARRERA
10	930 116 813 00	guide tube		1	TURBO
10	915 116 087 04	guide tube		1	CARRERA
10A	999 701 359 40	o-ring 40 X 1,5		1	CARRERA
11	N 012 006 4	lock ring B 6		2	TURBO
12	900 119 017 02	cheese-hd. screw M 6 X 15		2	TURBO
12	N 033 040 1	screw, csk.-head M 6 X 14		2	CARRERA
13	930 116 713 06	clutch operating lever		1	TURBO

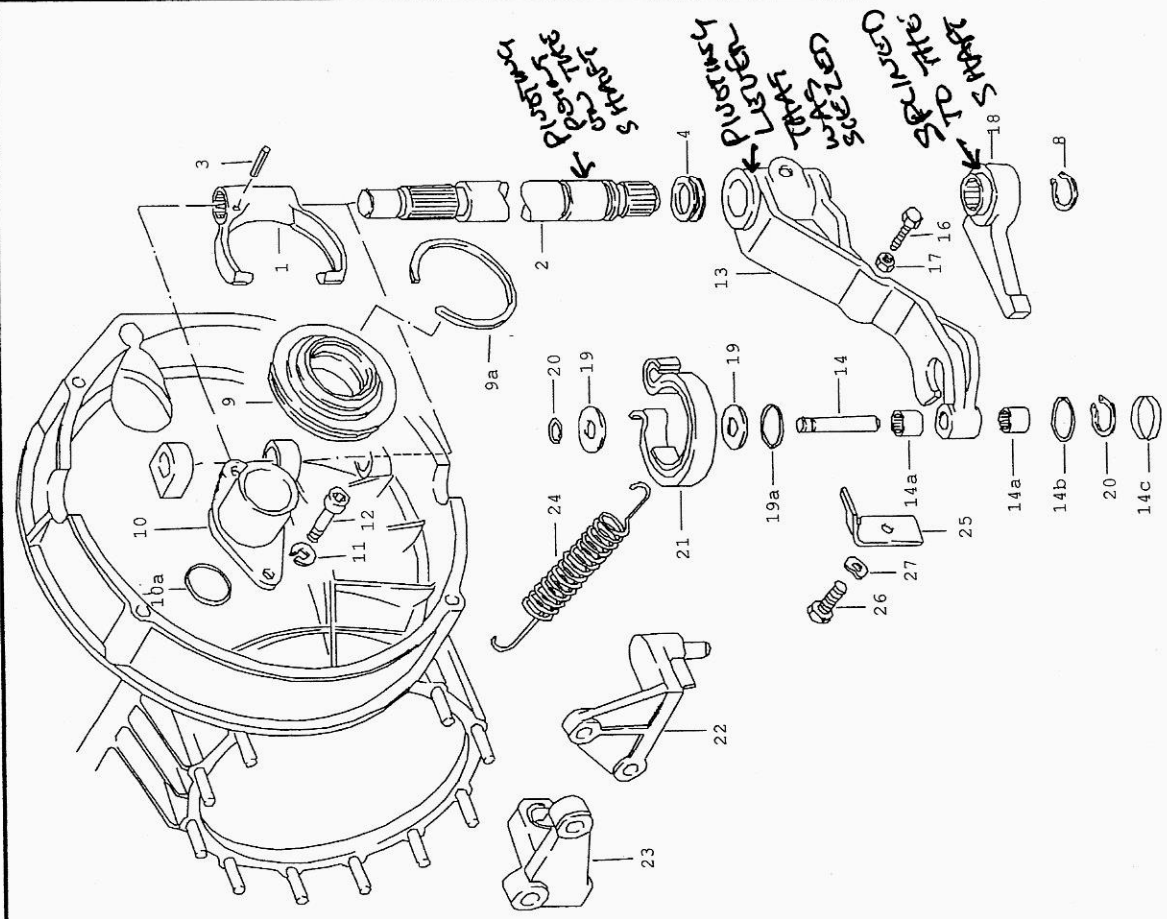

REPAIR ORDER

deJung Motorsport
 459 Portal St. Suite A
 Cotati, CA 94931
 (707) 664-8002
 BAR #:A.C. 101025
 EPA# CAL000064429

R/O # : 12653
 Name : F
 Date : 01/18/2008
 License # : 1PCY741
 Make : PORSCHE
 Model : CARRERA
 Year : 86
 Mileage : 195454 Save Parts : NO
 VIN : WPOAB0916GS120538

L. N
 . CA

LABOR	AMOUNT
Major Service:	600.00
Tune up.	
Adjust valves.	
Full service.	
R&R the alternator / cooling fan, drive belt.	
R&R the A.C. drive belt.	
Weld the throttle pin (pressed fitment was loose) at the transmission bell crank.	
Hydraulic system flush.	70.00

PARTS	All parts new unless stated used or remanufactured	PRICE	QTY	AMOUNT
OC 54	OIL FILTER	16.28	1	16.28
930 110 393 00	AIR FILTER	19.57	1	19.57
928 110 253 06	FUEL FILTER	38.33	1	38.33
PK 03	V/C GASKET KIT	46.71	1	46.71
930 602 919 00	CAP	77.36	1	77.36
930 602 902 01	ROTOR	19.57	1	19.57
4055	SPARK PLUG	11.28	6	67.68
10	**ENGINE OIL(PTS.)	1.60	22	35.20
01	TECHRON	7.50	1	7.50
03	WASHER SOLVENT	3.50	1	3.50
AB	BRAKE FLUID P/LITER	17.60	1	17.60
12.5X1155	AC BELT	16.18	1	16.18
9.5X710	BELT	11.89	1	11.89

Original Estimate : 1,085.26

Increases to Estimate					
Date	Time	OK'd By	Phone	Emp.	Increase

LABOR	670.00
PARTS	377.37
SUBLETS	.00
	.00
HAZARDOUS MATERIALS	8.64
SUB TOTAL	1,056.01
TAX	29.25
TOTAL	1,085.26

Parts & labor conditionally guaranteed 4,000 mi./ 90 days.

I hereby authorize DEJUNG MOTORSPORT to perform the repair work listed above along with necessary materials. You and your employees may operate the above vehicle for purposes of testing, inspection, or delivery at my risk. An express mechanics lien is acknowledged on above vehicle to secure the amount of repairs. Thereto it is understood that this company assumes no responsibility for loss or damage by theft or fire to vehicles placed with them for storage, sale, repair, or while road testing.

Authorized by : _____ Date : _____

REPAIR ORDER

deJung Motorsport
 459 Portal St. Suite A
 Cotati, CA 94931
 (707) 664-8002
 BAR #:A.C. 101025
 EPA# CAL000064429

R/O # : 11830
 Name :
 Date : 06/26/2006
 License # : 1PCY741
 Make : PORSCHE
 Model : CARRERA
 Year : 86
 Mileage : 182206 Save Parts : NO
 VIN : WPOAB0916GS120538

. CA

LABOR	AMOUNT
R&R idle control valve.	.00

PARTS	PRICE	QTY	AMOUNT
All parts new unless stated used or remanufactured 930 606 161 00 IDLE SPEED REGULATOR	188.52	1	188.52

RECOMMENDATIONS AND TECHNICIANS NOTES

Windshield squirter contacts erratic.(lever)

Original Estimate : 203.13

Increases to Estimate					
Date	Time	OK'd By	Phone	Emp.	Increase

LABOR	.00
PARTS	188.52
SUBLETS	.00
SUB TOTAL	188.52
TAX	14.61
TOTAL	<u>203.13</u>

Parts & labor conditionally guaranteed 4,000 mi./ 90 days.

I hereby authorize DEJUNG MOTORSPORT to perform the repair work listed above along with necessary materials. You and your employees may operate the above vehicle for purposes of testing, inspection, or delivery at my risk. An express mechanics lien is acknowledged on above vehicle to secure the amount of repairs. Thereto it is understood that this company assumes no responsibility for loss or damage by theft or fire to vehicles placed with them for storage, sale, repair, or while road testing.

Authorized by : _____ Date : _____

REPAIR ORDER

deJung Motorsport
 459 Portal St. Suite A
 Cotati, CA 94931
 (707) 664-8002
 BAR #:A.C. 101025
 EPA# CAL000064429

R/O # : 11789
 Name :
 Date : 06/02/2006
 License # : 1PCY741
 Make : PORSCHE
 Model : CARRERA
 Year : 86
 Mileage : 181377 Save Parts : NO
 VIN : WPOAB0916GS120538

CA

LABOR	AMOUNT
Check out non op AC / fan.	157.50
Trace the problem to a relay in the front trunk area.	
Replace the relay.	

PARTS All parts new unless stated used or remanufactured	PRICE	QTY	AMOUNT
0 332 019 150 OXYGEN SYSTEM RELAY	8.25	1	8.25

RECOMMENDATIONS AND TECHNICIANS NOTES

Windshield squirter contacts erratic.(lever)

Original Estimate : 166.39

Increases to Estimate						
Date	Time	OK'd By	Phone	Emp.	Increase	

Parts & labor conditionally guaranteed 4,000 mi./ 90 days.

LABOR	157.50
PARTS	8.25
SUBLETS	.00
	.00
SUB TOTAL	165.75
TAX	.64
TOTAL	<u>166.39</u>

I hereby authorize DEJUNG MOTORSPORT to perform the repair work listed above along with necessary materials. You and your employees may operate the above vehicle for purposes of testing, inspection, or delivery at my risk. An express mechanics lien is acknowledged on above vehicle to secure the amount of repairs. Thereto it is understood that this company assumes no responsibility for loss or damage by theft or fire to vehicles placed with them for storage, sale, repair, or while road testing.

Authorized by : _____ Date : _____

REPAIR ORDER

deJung Motorsport
 459 Portal St. Suite A
 Cotati, CA 94931
 (707) 664-8002
 BAR #:A.C. 101025
 EPA# CAL000064429

R/O # : **11757**
 Name : _____
 Date : 05/16/2006
 License # : 1PCY741
 Make : PORSCHE
 Model : CARRERA
 Year : 86
 Mileage : 180660 Save Parts : NO
 VIN : WPOAB0916GS120538

, CA

LABOR	AMOUNT
15K service:	540.00
Tune up.	
Adjust valves.	
full service.	
 Advise customer on dash cracks.	 .00

PARTS	All parts new unless stated used or remanufactured	PRICE	QTY	AMOUNT
OC 54	OIL FILTER	14.64	1	14.64
930 110 393 00	AIR FILTER	18.87	1	18.87
928 110 253 06	FUEL FILTER	41.58	1	41.58
930 602 919 00	CAP	74.00	1	74.00
930 602 902 01	ROTOR	19.28	1	19.28
4055	SPARK PLUG	10.42	6	62.52
PK 03	V/C GASKET KIT	38.00	1	38.00
10	**ENGINE OIL(PTS.)	1.25	22	27.50
GL5-S	GEAR OIL-SWEPKO 1/2 PT	3.00	12	36.00
01	TECHRON	7.50	1	7.50
03	WASHER SOLVENT	3.50	1	3.50

RECOMMENDATIONS AND TECHNICIANS NOTES

Windshield squirter contacts erratic.(lever)

Original Estimate : 980.63

Increases to Estimate					
Date	Time	OK'd By	Phone	Emp.	Increase

Parts & labor conditionally guaranteed 4,000 mi./ 90 days.

LABOR	540.00
PARTS	343.39
SUBLETS	.00
	.00
HAZARDOUS MATERIALS	10.32
SUB TOTAL	893.71
TAX	26.61
TOTAL	<u>920.32</u>

I hereby authorize DEJUNG MOTORSPORT to perform the repair work listed above along with necessary materials. You and your employees may operate the above vehicle for purposes of testing, inspection, or delivery at my risk. An express mechanics lien is acknowledged on above vehicle to secure the amount of repairs. Thereto it is understood that this company assumes no responsibility for loss or damage by theft or fire to vehicles placed with them for storage, sale, repair, or while road testing.

Authorized by : _____ Date : _____

REPAIR ORDER

deJung Motorsport
 459 Portal St. Suite A
 Cotati, CA 94931
 (707) 664-8002
 BAR #:A.C. 101025
 EPA# CAL000064429

R/O # : **11406**
 Name _____
 Date : 10/05/2005
 License # : 1PCY741
 Make : PORSCHE
 Model : CARRERA
 Year : 86
 Mileage : 175876 Save Parts : NO
 VIN : WPOAB0916GS120538

. CA

LABOR	AMOUNT
R&R rear brake rotors,pads and wear sensors. Adjust parking brakes. Min allowed rotor thickness .890 Left measured .880 Right measured .882	108.00
Change engine oil and filter. Check transaxle oil level. Inspect brakes. Check tire pressures. Check lights. Check brake fluid level.	90.00

PARTS	All parts new unless stated used or remanufactured	PRICE	QTY	AMOUNT
911 352 041 08	BRAKE DISK	125.00	2	250.00
944 612 211 02	BRAKE PAD SENSOR	15.89	2	31.78
911 352 950 01	BRAKE PADS	71.84	1	71.84
OC 54	OIL FILTER	13.70	1	13.70
10	**ENGINE OIL(PTS.)	1.25	22	27.50
4602227	COPPER WASHER	.60	2	1.20
01	TECHRON	7.50	1	7.50
03	WASHER SOLVENT	2.50	1	2.50

RECOMMENDATIONS AND TECHNICIANS NOTES
 Windshield squirter contacts erratic.(lever)

Original Estimate : 644.13

Increases to Estimate					
Date	Time	OK'd By	Phone	Emp.	Increase

LABOR	198.00
PARTS	406.02
SUBLETS	.00
	.00
HAZARDOUS MATERIALS	8.64
SUB TOTAL	612.66
TAX	31.47
TOTAL	644.13

Parts & labor conditionally guaranteed 4,000 mi./ 90 days.

I hereby authorize DEJUNG MOTORSPORT to perform the repair work listed above along with necessary materials. You and your employees may operate the above vehicle for purposes of testing, inspection, or delivery at my risk. An express mechanics lien is acknowledged on above vehicle to secure the amount of repairs. Thereto it is understood that this company assumes no responsibility for loss or damage by theft or fire to vehicles placed with them for storage, sale, repair, or while road testing.

Authorized by : _____ Date : _____

REPAIR ORDER

deJung Motorsport
 459 Portal St. Suite A
 Cotati, CA 94931
 (707) 664-8002
 BAR #:A.C. 101025
 EPA# CAL000064429

R/O # : 11065
 Name :
 Date : 03/08/2005
 License # : 1PCY741
 Make : PORSCHE
 Model : CARRERA
 Year : 86
 Mileage : 170134 Save Parts : NO
 VIN : WPOAB0916GS120538

____ N

 , CA

LABOR	AMOUNT
Change engine oil and filter.	90.00
Check transaxle oil level.	
Inspect brakes.	
Check tire pressures.	
Check lights.	
R&R left taillight/brake light bulb.	
R&R airfilter.	

PARTS	All parts new unless stated used or remanufactured	PRICE	QTY	AMOUNT
OC 54	OIL FILTER	13.70	1	13.70
10	**ENGINE OIL(PTS.)	1.25	22	27.50
4602227	COPPER WASHER	.38	2	.76
01	TECHRON	7.50	1	7.50
03	WASHER SOLVENT	2.50	1	2.50
1157	BULB	1.94	1	1.94
930 110 393 00	AIR FILTER	22.07	1	22.07

RECOMMENDATIONS AND TECHNICIANS NOTES

Windshield squirter contacts erratic.(lever)

Original Estimate : 180.31

Increases to Estimate						
Date	Time	OK'd By	Phone	Emp.	Increase	

LABOR	90.00
PARTS	75.97
SUBLETS	.00
	.00
HAZARDOUS MATERIALS	8.64
SUB TOTAL	174.61
TAX	5.70
TOTAL	<u>180.31</u>

Parts & labor conditionally guaranteed 4,000 mi / 90 days.

I hereby authorize DEJUNG MOTORSPORT to perform the repair work listed above along with necessary materials. You and your employees may operate the above vehicle for purposes of testing, inspection, or delivery at my risk. An express mechanics lien is acknowledged on above vehicle to secure the amount of repairs. Thereto it is understood that this company assumes no responsibility for loss or damage by theft or fire to vehicles placed with them for storage, sale, repair, or while road testing.

Authorized by : _____ Date : _____

REPAIR ORDER

deJung Motorsport
 459 Portal St. Suite A
 Cotati, CA 94931
 (707) 664-8002
 BAR #:A.C. 101025
 EPA# CAL000064429

R/O # : **10804**
 Name : _____
 Date : 10/04/2004
 License # : 1PCY741
 Make : PORSCHE
 Model : CARRERA
 Year : 86
 Mileage : 165730 Save Parts : NO
 VIN : WPOAB0916GS120538

, CA

LABOR	AMOUNT
R&R oil line,engine crossover to thermostat.	87.00
R&R oil hose,oil tank to cooler.	
OIL LINE LIST PRICE \$259.90CHARGE \$172.29**	
R&I right door panel.	108.75
R&R door lock motor.	
Modify wiring for new style door lock motor.	
Check left brake light bulb.	.00
Correct contact,bulb in holder.	

PARTS	All parts new unless stated used or remanufactured	PRICE	QTY	AMOUNT
911 624 211 01	DOOR LOCK MOTOR	99.31	1	99.31
930 107 743 12	OIL LINE	172.29	1	172.29
911 107 233 00	HOSE	29.54	1	29.54
10	**ENGINE OIL(PTS.)	1.25	2	2.50
	MALE CONNECTOR IN PLASTIC HOUSING	1.00	10	10.00
5589928	FEM SPADE CONN	.45	20	9.00

RECOMMENDATIONS AND TECHNICIANS NOTES

Windshield squirter contacts erratic.(lever)

Original Estimate : 543.23

Increases to Estimate					
Date	Time	OK'd By	Phone	Emp.	Increase

LABOR	195.75
PARTS	322.64
SUBLETS	.00
	.00
HAZARDOUS MATERIALS	0.64
SUB TOTAL	519.03
TAX	24.20
TOTAL	<u>543.23</u>

Parts & labor conditionally guaranteed 4,000 mi./ 90 days.

I hereby authorize DEJUNG MOTORSPORT to perform the repair work listed above along with necessary materials. You and your employees may operate the above vehicle for purposes of testing, inspection, or delivery at my risk. An express mechanics lien is acknowledged on above vehicle to secure the amount of repairs. Thereto it is understood that this company assumes no responsibility for loss or damage by theft or fire to vehicles placed with them for storage, sale, repair, or while road testing.

Authorized by : _____ Date : _____

REPAIR ORDER

deJung Motorsport
 459 Portal St. Suite A
 Cotati, CA 94931
 (707) 664-8002
 BAR #:A.C. 101025
 EPA# CAL000064429

R/O # : 10799
 Name :
 Date : 09/29/2004
 License # : 1PCY741
 Make : PORSCHE
 Model : CARRERA
 Year : 86
 Mileage : 165551 Save Parts : NO
 VIN : WPOAB0916GS120538

. CA

LABOR	AMOUNT
Major service:	522.00
Tune up.	
Adjust valves.	
Full service.	
Correct connection at right taillight /bulb holder.	
Check out door locks.	.00
See below.	
Glue right outside mirror glass	.00

PARTS	All parts new unless stated used or remanufactured	PRICE	QTY	AMOUNT
928 110 253 06	FUEL FILTER	38.33	1	38.33
930 110 393 00	AIR FILTER	22.07	1	22.07
OC 54	OIL FILTER	9.65	1	9.65
930 602 919 00	CAP	85.59	1	85.59
930 602 902 01	ROTOR	14.74	1	14.74
B7EVX	PLUG	10.11	6	60.66
PK 03	V/C GASKET KIT	32.37	1	32.37
10	**ENGINE OIL(PTS.)	1.25	22	27.50
4602227	COPPER WASHER	.38	2	.76
01	TECHRON	7.50	1	7.50
03	WASHER SOLVENT	2.50	1	2.50

RECOMMENDATIONS AND TECHNICIANS NOTES

Right door lock assembly.
 Oil line,crossover to thermostat.

Original Estimate : 854.94

Increases to Estimate					
Date	Time	OK'd By	Phone	Emp.	Increase

LABOR	522.00
PARTS	301.67
SUBLETS	.00
	.00
HAZARDOUS MATERIALS	8.64
SUB TOTAL	832.31
TAX	22.63
TOTAL	854.94

Parts & labor conditionally guaranteed 4,000 mi./ 90 days.

I hereby authorize DEJUNG MOTORSPORT to perform the repair work listed above along with necessary materials. You and your employees may operate the above vehicle for purposes of testing, inspection, or delivery at my risk. An express mechanics lien is acknowledged on above vehicle to secure the amount of repairs. Thereto it is understood that this company assumes no responsibility for loss or damage by theft or fire to vehicles placed with them for storage, sale, repair, or while road testing.

Authorized by : _____ Date : _____

REPAIR ORDER

deJung Motorsport
 459 Portal St. Suite A
 Cotati, CA 94931
 (707) 664-8002
 BAR #:A.C. 101025
 EPA# CAL000064429

R/O # : **10130**
 Name :
 Date : 08/12/2003
 License # : 1PCY741
 Make : PORSCHE
 Model : CARRERA
 Year : 86
 Mileage : 155710 Save Parts : NO
 VIN : WPOAB0916GS120538

, CA

LABOR	AMOUNT
Change engine oil and filter.	78.00
Check transaxle oil level.	
Inspect brakes.	
Check tire pressures.	
Check lights.	
Check brake fluid level.	
Drop the rear engine mount.	214.50
R&R jack shaft "O" ring seal.	

PARTS	All parts new unless stated used or remanufactured	PRICE	QTY	AMOUNT
OC 54	OIL FILTER	9.65	1	9.65
10	**ENGINE OIL(PTS.)	1.00	22	22.00
4602227	COPPER WASHER	.38	2	.76
01	TECHRON	7.50	1	7.50
03	WASHER SOLVENT	2.25	1	2.25
930 107 272 01	OIL CAP GASKET	2.00	1	2.00
999 707 315 40	O RING SEAL	3.50	1	3.50

RECOMMENDATIONS AND TECHNICIANS NOTES

Windshield squirter contacts erratic.(lever)

Original Estimate : 352.37

Increases to Estimate					
Date	Time	OK'd By	Phone	Emp.	Increase

Parts & labor conditionally guaranteed 4,000 mi./90 days.

I hereby authorize DEJUNG MOTORSPORT to perform the repair work listed above along with necessary materials. You and your employees may operate the above vehicle for purposes of testing, inspection, or delivery at my risk. An express mechanics lien is acknowledged on above vehicle to secure the amount of repairs. Thereto it is understood that this company assumes no responsibility for loss or damage by theft or fire to vehicles placed with them for storage, sale, repair, or while road testing.

LABOR	292.50
PARTS	47.66
SUBLETS	.00
	.00
HAZARDOUS MATERIALS	8.64
SUB TOTAL	348.80
TAX	3.57
TOTAL	<u>352.37</u>

Authorized by : _____ Date : _____

REPAIR ORDER

deJung Motorsport
 459 Portal St. Suite A
 Cotati, CA 94931
 (707) 664-8002
 BAR #:A.C. 101025
 EPA# CAL000064429

R/O # : 10464
 Name :
 Date : 03/19/2004
 License # : 1PCY741
 Make : PORSCHE
 Model : CARRERA
 Year : 86
 Mileage : 160200 Save Parts : NO
 VIN : WPOAB0916GS120538

, CA

LABOR	AMOUNT
Install clock.	.00

SUBLETS	AMOUNT
Repair speedo	135.00
UPS	7.65

RECOMMENDATIONS AND TECHNICIANS NOTES

Windshield squirter contacts erratic.(lever)

Original Estimate : 142.65

Increases to Estimate					
Date	Time	OK'd By	Phone	Emp.	Increase

LABOR	.00
PARTS	.00
SUBLETS	142.65
	.00
SUB TOTAL	142.65
TAX	.00
TOTAL	<u>142.65</u>

Parts & labor conditionally guaranteed 4,000 mi./ 90 days.

I hereby authorize DEJUNG MOTORSPORT to perform the repair work listed above along with necessary materials. You and your employees may operate the above vehicle for purposes of testing, inspection, or delivery at my risk. An express mechanics lien is acknowledged on above vehicle to secure the amount of repairs. Thereto it is understood that this company assumes no responsibility for loss or damage by theft or fire to vehicles placed with them for storage, sale, repair, or while road testing.

Authorized by : _____ Date : _____

REPAIR ORDER

deJung Motorsport
 459 Portal St. Suite A
 Cotati, CA 94931
 (707) 664-8002
 BAR #:A.C. 101025
 EPA# CAL000064429

R/O # : 10442
 Name :
 Date : 03/09/2004
 License # : 1PCY741
 Make : PORSCHE
 Model : CARRERA
 Year : 86
 Mileage : 160100 Save Parts : NO
 VIN : WPOAB0916GS120538

LABOR	AMOUNT
Change engine oil and filter.	87.00
Check transaxle oil level.	
Inspect brakes.	
Check tire pressures.	
Check lights.	
Check brake fluid level.	
R&R drivers window switch.	43.50
Check for erratic clock operation:	
1. Power OK.	
2. Ground circuit OK.	
3. Remove clock, send out for repair.	
Check freon level:	
1. Temp out center vent 56 degrees.	
2. Temp out side vent 53 degrees.	

PARTS	All parts new unless stated used or remanufactured	PRICE	QTY	AMOUNT
OC 54	OIL FILTER	9.65	1	9.65
10	**ENGINE OIL(PTS.)	1.00	22	22.00
4602227	COPPER WASHER	.38	2	.76
01	TECHRON	7.50	1	7.50
03	WASHER SOLVENT	2.50	1	2.50
911 613 621 03	WINDOW SWITCH	20.38	1	20.38

RECOMMENDATIONS AND TECHNICIANS NOTES

Windshield squirter contacts erratic.(lever)

Original Estimate : 206.64

Increases to Estimate					
Date	Time	OK'd By	Phone	Emp.	Increase

LABOR	130.50
PARTS	62.79
SUBLETS	.00
	.00
HAZARDOUS MATERIALS	8.64
SUB TOTAL	201.93
TAX	4.71
TOTAL	<u>206.64</u>

Parts & labor conditionally guaranteed 4,000 mi./ 90 days.

I hereby authorize DEJUNG MOTORSPORT to perform the repair work listed above along with necessary materials. You and your employees may operate the above vehicle for purposes of testing, inspection, or delivery at my risk. An express mechanics lien is acknowledged on above vehicle to secure the amount of repairs. Thereto it is understood that this company assumes no responsibility for loss or damage by theft or fire to vehicles placed with them for storage, sale, repair, or while road testing.

Authorized by : _____ Date : _____

REPAIR ORDER

deJung Motorsport
459 Portal St. Suite A
Cotati, CA 94931
(707) 664-8002
BAR #:A.C. 101025
EPA# CAL000064429

#: 10037
Name :
Date : 06/10/2003
License # : 1PCY741
Make : PORSCHE
Model : CARRERA
Year : 86
Mileage : 154000 Save Parts : NO
VIN : WPOAB0916GS120538

CA

LABOR	AMOUNT
Car towed in.	85.80
Check out non start.	
Trace the problem to a bad fuel pump.	
R&R fuel pump.	
Check oil leak at back of engine.	.00
Possible jack shaft cover.	
Will need to remove the rear engine mount to inspect.	

PARTS	PRICE	QTY	AMOUNT
All parts new unless stated used or remanufactured			
944 608 102 04 FUEL PUMP	196.46	1	196.46

RECOMMENDATIONS AND TECHNICIANS NOTES

Windshield squirter contacts erratic.(lever)

Original Estimate : 296.99

Increases to Estimate					
Date	Time	OK'd By	Phone	Emp.	Increase

LABOR	85.80
PARTS	196.46
SUBLETS	.00
	.00
SUB TOTAL	282.26
TAX	14.73
TOTAL	<u>296.99</u>

Parts & labor conditionally guaranteed 4,000 mi./ 90 days.

I hereby authorize DEJUNG MOTORSPORT to perform the repair work listed above along with necessary materials. You and your employees may operate the above vehicle for purposes of testing, inspection, or delivery at my risk. An express mechanics lien is acknowledged on above vehicle to secure the amount of repairs. Thereto it is understood that this company assumes no responsibility for loss or damage by theft or fire to vehicles placed with them for storage, sale, repair, or while road testing.

Authorized by : _____ Date : _____

deJung Motorsport
459 Portal St. Suite A
Cotati, CA 94931
(707) 664-8002
BAR #:A.C. 101025
EPA# CAL000064429

K/O # : 9995
Name :
Date : 05/21/2003
License # : 1PCY741
Make : PORSCHE
Model : CARRERA
Year : 86
Mileage : 153636 Save Parts : NO
VIN : WPOAB0916GS120538

N

, CA

LABOR	AMOUNT
R&R rear shock absorbers	97.50
Check AC system for leaks. None found.	78.00
Charge AC system.(temp 83* > 58*)	
Take car over to car wash.	46.80
Clean off the back of the engine(fan/pully area)	

PARTS	All parts new unless stated used or remanufactured	PRICE	QTY	AMOUNT
B46-0169	BILSTEIN	157.00	2	314.00
R-12	FREON P/CAN	61.23	3	183.69

RECOMMENDATIONS AND TECHNICIANS NOTES

Windshield squirter contacts erratic.(lever)

Original Estimate : 757.32

Increases to Estimate					
Date	Time	OK'd By	Phone	Emp.	Increase

LABOR	222.30
PARTS	497.69
SUBLETS	.00
	.00
SUB TOTAL	719.99
TAX	37.33
TOTAL	<u>757.32</u>

Parts & labor conditionally guaranteed 4,000 mi./ 90 days.

I hereby authorize DEJUNG MOTORSPORT to perform the repair work listed above along with necessary materials. You and your employees may operate the above vehicle for purposes of testing, inspection, or delivery at my risk. An express mechanics lien is acknowledged on above vehicle to secure the amount of repairs. Thereto it is understood that this company assumes no responsibility for loss or damage by theft or fire to vehicles placed with them for storage, sale, repair, or while road testing.

Authorized by : _____ Date : _____

REPAIR ORDER

deJung Motorsport
 459 Portal St. Suite A
 Cotati, CA 94931
 (707) 664-8002
 BAR #:A.C. 101025
 EPA# CAL000064429

IO # : 9953
 Name :
 Date : 04/22/2003
 License # : 1PCY741
 Make : PORSCHE
 Model : CARRERA
 Year : 86
 Mileage : 152497 Save Parts : NO
 VIN : WPOAB0916GS120538

, CA

LABOR	AMOUNT
Car towed in.	210.60
Check out poor running engine.	
Customer states,rough running,hard to start,smoke out tailpipe.	
Test fuel injection pressure.42 lbs.,OK.	
Check all DME/fuel injection plugs at engine.	
R&R head temp sensor.	
Check for clunk at the rear of the car.	
Found no loose suspension or related parts.Possible shock noise.	

PARTS	All parts new unless stated used or remanufactured	PRICE	QTY	AMOUNT
930 606 915 00	HEAD TEMP SENSOR	71.57	1	71.57

RECOMMENDATIONS AND TECHNICIANS NOTES

Windshield squirter contacts erratic.(lever)

Original Estimate : 76.94

Increases to Estimate					
Date	Time	OK'd By	Phone	Emp.	Increase

LABOR	210.60
PARTS	71.57
SUBLETS	.00
	.00
SUB TOTAL	282.17
TAX	5.37
TOTAL	<u>287.54</u>

Parts & labor conditionally guaranteed 4,000 mi./ 90 days.

I hereby authorize DEJUNG MOTORSPORT to perform the repair work listed above along with necessary materials. You and your employees may operate the above vehicle for purposes of testing, inspection, or delivery at my risk. An express mechanics lien is acknowledged on above vehicle to secure the amount of repairs. Thereto it is understood that this company assumes no responsibility for loss or damage by theft or fire to vehicles placed with them for storage, sale, repair, or while road testing.

Authorized by : _____ Date : _____

REPAIR ORDER

deJung Motorsport
459 Portal St.
Cotati, CA 94931
(707) 664-8002
BAR #:A.C. 101025
EPA# CAL000064429

R/O # : 9851
Name
Date : 02/13/03
License # : 1PCY741
Make : PORSCHE
Model : CARRERA
Year : 86
Mileage : 150501 Save Parts : NO
VIN : WPOAB0916GS120538

F
, CA

LABOR	AMOUNT
Major service: Tune up. Adjust valves. Full service.	468.00
Inspect for engine oil leak.(pully area) The leak appears to be from the underside of the #8 bearing. Need to steam clean the area then recheck.	0.00
Engine hood will not latch correctly.Check out. Adjust hood latch pin. Clean and lube hood latch pin. Clean and lube hood latch.	0.00
Install CARRERA badge on back hood.	0.00
Clean both courtesy light switches.(door jam area) Replace left switch boot.	0.00
Knob,for dash slide,on order.	0.00

PARTS	All parts new unless stated used or remanufactured	PRICE	QTY	AMOUNT
928 110 253 00	FUEL FILTER	23.04	1	23.04
930 110 393 00	AIR FILTER	17.37	1	17.37
OC 54	OIL FILTER	9.65	1	9.65
930 602 919 00	CAP	51.25	1	51.25
930 602 902 01	ROTOR	15.67	1	15.67
B7EVX	PLUG	7.79	6	46.74
PK 03	V/C GASKET KIT	32.37	1	32.37
10	**ENGINE OIL(PTS.)	1.00	22	22.00
GL5	GEAR OIL (1/2 PINT)	1.40	12	16.80
01	TECHRON	7.50	1	7.50
03	WASHER SOLVENT	2.25	1	2.25

REPAIR ORDER

deJung Motorsport
 459 Portal St.
 Cotati, CA 94931
 (707) 664-8002
 BAR #:A.C. 101025
 EPA# CAL000064429

R/O # : 9851

Page : 2

Name :

Date : 02/13/03

License # : 1PCY741

Make : PORSCHE

Model : CARRERA

Year : 86

Mileage : 150501

Save Parts : NO

VIN : WPOAB0916GS120538

, CA

PARTS	All parts new unless stated used or remanufactured	PRICE	QTY	AMOUNT
3893	BULB	1.74	1	1.74
901 615 616 20	RUBBER CAP	3.24	1	3.24

RECOMMENDATIONS AND TECHNICIANS NOTES

Windshield squirter contacts erratic.(lever)

Original Estimate : 746.66

Increases to Estimate					
Date	Time	OK'd By	Phone	Emp.	New Total

LABOR	468.00
PARTS	249.62
SUBLETS	0.00
	0.00
HAZARDOUS MATERIALS	10.32
SUB TOTAL	727.94
TAX	18.72
TOTAL	\$ 746.66

Parts & labor conditionally guaranteed 4,000 mi./ 90 days.

I hereby authorize DEJUNG MOTORSPORT to perform the repair work listed above along with necessary materials. You and your employees may operate the above vehicle for purposes of testing, inspection, or delivery at my risk. An express mechanics lien is acknowledged on above vehicle to secure the amount of repairs. Thereto it is understood that this company assumes no responsibility for loss or damage by theft or fire to vehicles placed with them for storage, sale, repair, or while road testing.

Authorized by : _____ Date : _____

REPAIR ORDER

deJung Motorsport
 459 Portal St.
 Cotati, CA 94931
 (707) 664-8002
 BAR #:A.C. 101025
 EPA# CAL000064429

R/O # : 9595
 Name :
 Date : 08/13/02
 License # : 1PCY741
 Make : PORSCHE
 Model : CARRERA
 Year : 86
 Mileage : 146258 Save Parts : NO
 VIN : WPOAB0916GS120538

1 _____ N

CA

LABOR	AMOUNT
R&R alternator fan belt.	19.50

PARTS	All parts new unless stated used or remanufactured	PRICE	QTY	AMOUNT
9.5X710	BELT	6.20	1	6.20

RECOMMENDATIONS AND TECHNICIANS NOTES

Windshield squirter contacts erratic.(lever)

Original Estimate : 26.17

Increases to Estimate					
Date	Time	OK'd By	Phone	Emp.	New Total

LABOR	19.50
PARTS	6.20
SUBLETS	.00
	.00
SUB TOTAL	25.70
TAX	.47
TOTAL	<u>26.17</u>

Parts & labor conditionally guaranteed 4,000 mi./ 90 days.

I hereby authorize DEJUNG MOTORSPORTS to perform the repair work listed above along with necessary materials. You and your employees may operate the above vehicle for purposes of testing, inspection, or delivery at my risk. An express mechanics lien is acknowledged on above vehicle to secure the amount of repairs. Thereto it is understood that this company assumes no responsibility for loss or damage by theft or fire to vehicles placed with them for storage, sale, repair, or while road testing.

Authorized by : _____ Date : _____

REPAIR ORDER

deJung Motorsport
 459 Portal St.
 Cotati, CA 94931
 (707) 664-8002
 BAR #:A.C. 101025
 EPA# CAL000064429

R/O # : 9582
 Name _____
 Date : 08/13/02
 License # : 1PCY741
 Make : PORSCHE
 Model : CARRERA
 Year : 86
 Mileage : 146258 Save Parts : NO
 VIN : WPOAB0916GS120538

, CA

LABOR	AMOUNT
R&I both axles.	
Clean, inspect and repack 4 C/V joints.	257.40
R&R 4 C/V boots.	

PARTS	All parts new unless stated used or remanufactured	PRICE	QTY	AMOUNT
928 332 924 02	C/V BOOT KIT	28.40	4	113.60

RECOMMENDATIONS AND TECHNICIANS NOTES

Windshield squirter contacts erratic.(lever)

Original Estimate : 264.41

Increases to Estimate					
Date	Time	OK'd By	Phone	Emp.	New Total

LABOR	257.40
PARTS	113.60
SUBLETS	.00
	.00
SUB TOTAL	371.00
TAX	8.52
TOTAL	<u>379.52</u>

Parts & labor conditionally guaranteed 4,000 mi./ 90 days.

I hereby authorize DEJUNG MOTORSPORTS to perform the repair work listed above along with necessary materials. You and your employees may operate the above vehicle for purposes of testing, inspection, or delivery at my risk. An express mechanics lien is acknowledged on above vehicle to secure the amount of repairs. Thereto it is understood that this company assumes no responsibility for loss or damage by theft or fire to vehicles placed with them for storage, sale, repair, or while road testing.

Authorized by : _____ Date : _____

REPAIR ORDER

deJung Motorsport
 459 Portal St.
 Cotati, CA 94931
 (707) 664-8002
 BAR #:A.C. 101025
 EPA# CAL000064429

R/O # : 9570
 Name :
 Date : 07/30/02
 License # : 1PCY741
 Make : PORSCHE
 Model : CARRERA
 Year : 86
 Mileage : 145809 Save Parts : NO
 VIN : WPOAB0916GS120538

DE
 , CA

LABOR	AMOUNT
Change engine oil and filter.	78.00
Check transaxle oil level.	
Inspect brakes.	
Check tire pressures.	
Check lights.	
Check brake fluid level.	
See below	
Correct non op right windshield squirter. See Steve.	39.00
Check for AC compressor noise. See Steve.	
Tighten right, outside mirror.	

PARTS	All parts new unless stated used or remanufactured	PRICE	QTY	AMOUNT
OC 54	OIL FILTER	9.65	1	9.65
10	**ENGINE OIL(PTS.)	1.00	22	22.00
4602227	COPPER WASHER	0.38	2	0.76
01	TECHRON	7.50	1	7.50
03	WASHER SOLVENT	2.25	1	2.25
MMW4.5	SQUIRTER HOSE 6"	1.08	1	1.08
VCT316T	PLASTIC "T"	0.50	1	0.50

RECOMMENDATIONS AND TECHNICIANS NOTES

Left inner C/V boot torn. Others have cracks. To: R&I 2 axles, clean, inspect, repack 4 C/V joints and replace 4 boots \$345.00.

Original Estimate : 172.66

Increases to Estimate					
Date	Time	OK'd By	Phone	Emp.	New Total

LABOR	117.00
PARTS	43.74
SUBLETS	0.00
	0.00
HAZARDOUS MATERIALS	8.64
SUB TOTAL	169.38
TAX	3.28
TOTAL	\$ 172.66

Parts & labor conditionally guaranteed 4,000 mi./ 90 days.

I hereby authorize DEJUNG MOTORSPORTS to perform the repair work listed above along with necessary materials. You and your employees may operate the above vehicle for purposes of testing, inspection, or delivery at my risk. An express mechanics lien is acknowledged on above vehicle to secure the amount of repairs. Thereto it is understood that this company assumes no responsibility for loss or damage by theft or fire to vehicles placed with them for storage, sale, repair, or while road testing.

Authorized by : _____ Date : _____

REPAIR ORDER

deJung Motorsport
 459 Portal St.
 Cotati, CA 94931
 (707) 664-8002
 BAR #: A.C. 101025
 EPA# CAL000064429

NO # : 9290
 Name :
 Date : 01/31/02
 License # : 1PCY741
 Make : PORSCHE
 Model : CARRERA
 Year : 86
 Mileage : 140407 Save Parts : NO
 VIN : WPOAB0916GS120538

, CA

LABOR	AMOUNT
Drain gas tank.	117.00
Remove gas tank.	
Remove all seperated undercoating from the gas tank.	
Send the gas tank out for repair.	
Clean off gas tank as needed with scuff pad.	175.50
Paint and undercoat gas tank as needed.	
Install gas tank to body seal.	
Install gas tank.	
Clean in trunk area as needed to correct surface rust. Undercoat cleaned areas.	

PARTS	All parts new unless stated used or remanufactured	PRICE	QTY	AMOUNT
	UNDERCOATING	5.00	1	5.00
901 504 932 20	GASKET-TANK TO BODY	24.69	1	24.69
	SCUFF PAD	5.00	1	5.00

SUBLETS	AMOUNT
Repair gas tank.	95.00
Freight(tank gasket)	5.50

RECOMMENDATIONS AND TECHNICIANS NOTES

Windshield squirter contacts erratic. (lever)

Original Estimate : 430.29

Increases to Estimate					
Date	Time	OK'd By	Phone	Emp.	New Total

LABOR	292.50
PARTS	34.69
SUBLETS	100.50
	.00
SUB TOTAL	427.69
TAX	2.60
TOTAL	<u>430.29</u>

Parts & labor conditionally guaranteed 4,000 mi./ 90 days.

I hereby authorize DEJUNG MOTORSPORTS to perform the repair work listed above along with necessary materials. You and your employees may operate the above vehicle for purposes of testing, inspection, or delivery at my risk. An express mechanics lien is acknowledged on above vehicle to secure the amount of repairs. Thereto it is understood that this company assumes no responsibility for loss or damage by theft or fire to vehicles placed with them for storage, sale, repair, or while road testing.

Authorized by : _____ Date : _____

REPAIR ORDER

deJung Motorsport
 459 Portal St.
 Cotati, CA 94931
 (707) 664-8002
 BAR #: A.C. 101025
 EPA# CAL000064429

K/O # : 9270
 Name : _____
 Date : 01/16/02
 License # : 1PCY741
 Make : PORSCHE
 Model : CARRERA
 Year : 86
 Mileage : 140063 Save Parts : NO
 VIN : WPOAB0916GS120538

N

, CA

LABOR	AMOUNT
Change engine oil and filter.	78.00
Check transaxle oil level.	
Inspect brakes.	
Check tire pressures.	
Check lights.	
Check brake fluid level.	
Check out fuel smell.	39.00
R&R 2 hoses at fuel filler neck.	

PARTS All parts new unless stated used or remanufactured		PRICE	QTY	AMOUNT
OC 54	OIL FILTER	9.65	1	9.65
10	**ENGINE OIL(PTS.)	1.00	22	22.00
4602227	COPPER WASHER	0.38	2	0.76
01	TECHRON	6.95	1	6.95
03	WASHER SOLVENT	2.25	1	2.25
	HOSE	2.00	1	2.00
5391220	CLAMP	1.00	4	4.00
928 628 623 00	CAP	0.75	1	0.75

RECOMMENDATIONS AND TECHNICIANS NOTES

Windshield squirter contacts erratic.(lever)

Original Estimate : 177.63

Increases to Estimate					
Date	Time	OK'd By	Phone	Emp.	New Total

LABOR	117.00
PARTS	48.36
SUBLETS	0.00
	0.00
HAZARDOUS MATERIALS	8.64
SUB TOTAL	174.00
TAX	3.63
TOTAL	\$ 177.63

Parts & labor conditionally guaranteed 4,000 mi./ 90 days.

I hereby authorize DEJUNG MOTORSPORTS to perform the repair work listed above along with necessary materials. You and your employees may operate the above vehicle for purposes of testing, inspection, or delivery at my risk. An express mechanics lien is acknowledged on above vehicle to secure the amount of repairs. Thereto it is understood that this company assumes no responsibility for loss or damage by theft or fire to vehicles placed with them for storage, sale, repair, or while road testing.

Authorized by : _____ Date : _____

REPAIR ORDER

deJung Motorsport
 459 Portal St.
 Cotati, CA 94931
 (707) 664-8002
 BAR #: A.C. 101025
 EPA# CAL000064429

Job #: 9044

Name :

Date : 07/26/01

License # : 1PCY741

Make : PORSCHE

Model : CARRERA

Year : 86

Mileage : 135280

Save Parts : NO

VIN : WPOAB0916GS120538

, CA

LABOR

Major service:	AMOUNT
Tune up.	420.00
Adjust valves.	
Full service.	
Tighten right outside mirror.	
Clear left squirter.	

PARTS All parts new unless stated used or remanufactured

		PRICE	QTY	AMOUNT
928 110 253 04	FUEL FILTER	17.50	1	17.50
930 110 393 00	AIR FILTER	16.95	1	16.95
OC 54	OIL FILTER	9.65	1	9.65
03202	DISTRIBUTOR CAP	45.00	1	45.00
04163	ROTOR	15.05	1	15.05
B7EV	SPARK PLUG	7.90	6	47.40
PK 03	V/C GASKET KIT	32.37	1	32.37
10	**ENGINE OIL(PTS.)	1.00	22	22.00
GL5-S	GEAR OIL-SWEPKO 1/2 PT	3.00	13	39.00
01	TECHRON	6.95	1	6.95
1156	BULB	1.88	1	1.88
03	WASHER SOLVENT	2.25	1	2.25

RECOMMENDATIONS AND TECHNICIANS NOTES

Windshield squirter contacts erratic.(lever)

Original Estimate : 705.02

Increases to Estimate					
Date	Time	OK'd By	Phone	Emp.	New Total

LABOR	420.00
PARTS	256.00
SUBLETS	0.00
	0.00
HAZARDOUS MATERIALS	10.46
SUB TOTAL	686.46
TAX	18.56
TOTAL	\$ 705.02

Parts & labor conditionally guaranteed 4,000 mi./ 90 days.

I hereby authorize DEJUNG MOTORSPORTS to perform the repair work listed above along with necessary materials. You and your employees may operate the above vehicle for purposes of testing, inspection, or delivery at my risk. An express mechanics lien is acknowledged on above vehicle to secure the amount of repairs. Thereto it is understood that this company assumes no responsibility for loss or damage by theft or fire to vehicles placed with them for storage, sale, repair, or while road testing.

Authorized by : _____ Date : _____

REPAIR ORDER

deJung Motorsport
 459 Portal St.
 Cotati, CA 94931
 (707) 664-8002
 BAR #: A.C. 101025
 EPA# CAL000064429

R# : 8868
 Name : _____
 Date : 03/29/01
 License # : 1PCY741
 Make : PORSCHE
 Model : CARRERA
 Year : 86
 Mileage : _____ Save Parts : NO
 VIN : WPOAB0916GS120538

_____ VN
 , CA

LABOR

Install mirror glass, left outside.	AMOUNT
	.00

PARTS All parts new unless stated used or remanufactured	PRICE	QTY	AMOUNT
911 731 035 08 GLASS-OUTER MIRROR	42.77	1	42.77

RECOMMENDATIONS AND TECHNICIANS NOTES

Windshield squirter contacts erratic.(lever)

Original Estimate : 45.87

Increases to Estimate					
Date	Time	OK'd By	Phone	Emp.	New Total

LABOR	.00
PARTS	42.77
SUBLETS	.00
	.00
SUB TOTAL	42.77
TAX	3.10
TOTAL	<u>45.87</u>

Parts & labor conditionally guaranteed 4,000 mi./ 90 days.

I hereby authorize DEJUNG MOTORSPORTS to perform the repair work listed above along with necessary materials. You and your employees may operate the above vehicle for purposes of testing, inspection, or delivery at my risk. An express mechanics lien is acknowledged on above vehicle to secure the amount of repairs. Thereto it is understood that this company assumes no responsibility for loss or damage by theft or fire to vehicles placed with them for storage, sale, repair, or while road testing.

Authorized by : _____ Date : _____

REPAIR ORDER

deJung Motorsport
 459 Portal St.
 Cotati, CA 94931
 (707) 664-8002
 BAR #:A.C. 101025
 EPA# CAL000064429

Key # : 8754
 Name _____
 Date : 01/08/01
 License # : 1PCY741
 Make : PORSCHE
 Model : CARRERA
 Year : 86
 Mileage : 130716 Save Parts : NO
 VIN : WPOAB0916GS120538

CA
 4

LABOR	AMOUNT
Change engine oil and filter.	70.00
Check transaxle oil level.	
Inspect brakes.	
Check tire pressures.	
Check lights.	
Check brake fluid level.	
Check out fog lights.R&R right bulb.	
Install steering shaft bushing.(upper bearing)	35.00
R&R drivers seat,electric switch.	52.50
Check out squirter.	14.00
R&R squirter pump for auxiliary reservoir.	

PARTS All parts new unless stated used or remanufactured		PRICE	QTY	AMOUNT
928 613 183 00	ELECTRIC SEAT SWITCH	91.10	1	91.10
928 347 739 02	BUSHING-STEERING SHAFT	12.52	1	12.52
OC 54	OIL FILTER	9.65	1	9.65
10	**ENGINE OIL(PTS.)	1.00	22	22.00
4602227	COPPER WASHER	0.38	2	0.76
01	TECHRON	6.95	1	6.95
03	WASHER SOLVENT	2.25	3	6.75
431 955 651	PUMP	33.72	1	33.72
H3	BULB	5.30	1	5.30

RECOMMENDATIONS AND TECHNICIANS NOTES

Windshield squirter contacts erratic.(lever)

Original Estimate : 382.57

Increases to Estimate					
Date	Time	OK'd By	Phone	Emp.	New Total

LABOR	171.50
PARTS	188.75
SUBLETS	0.00
	0.00
HAZARDOUS MATERIALS	8.64
SUB TOTAL	368.89
TAX	13.68
TOTAL	\$ 382.57

Parts & labor conditionally guaranteed 4,000 mi./ 90 days.

I hereby authorize DEJUNG MOTORSPORTS to perform the repair work listed above along with necessary materials. You and your employees may operate the above vehicle for purposes of testing, inspection, or delivery at my risk. An express mechanics lien is acknowledged on above vehicle to secure the amount of repairs. Thereto it is understood that this company assumes no responsibility for loss or damage by theft or fire to vehicles placed with them for storage, sale, repair, or while road testing.

Authorized by : _____ Date : _____

REPAIR ORDER

g Motorsport
 ortal St.
 i, CA 94931
 /) 664-8002
 R #:A.C. 101025
 A# CAL000064429

R/C 8606
 Name :
 Date : 09/20/00
 License # : 1PCY741
 Make : PORSCHE
 Model : CARRERA
 Year : 86
 Mileage : 128152 Save Parts : NO
 VIN : WPOAB0916GS120538

CA

LABOR	AMOUNT
Remove speedo. 9-11-00	14.00
Install speedo. 9-20-00	

SUBLETS	AMOUNT
Repair speedo.	130.00
Freight	2.71

RECOMMENDATIONS AND TECHNICIANS NOTES

Windshield squirter contacts erratic.(lever)

Original Estimate : 146.71

Increases to Estimate					
Date	Time	OK'd By	Phone	Emp.	New Total

LABOR	14.00
PARTS	.00
SUBLETS	132.71
	.00
SUB TOTAL	146.71
TAX	.00
TOTAL	<u>146.71</u>

Parts & labor conditionally guaranteed 4,000 mi./ 90 days.

I hereby authorize DEJUNG MOTORSPORTS to perform the repair work listed above along with necessary materials. You and your employees may operate the above vehicle for purposes of testing, inspection, or delivery at my risk. An express mechanics lien is acknowledged on above vehicle to secure the amount of repairs. Thereto it is understood that this company assumes no responsibility for loss or damage by theft or fire to vehicles placed with them for storage, sale, repair, or while road testing.

Authorized by : _____ Date : _____

REPAIR ORDER

deJung Motorsport
 459 Portal St.
 Cotati, CA 94931
 (707) 664-8002
 BAR #:A.C. 101025
 EPA# CAL000064429

R/C: 8532
 Name :
 Date : 08/10/00
 License # : 1PCY741
 Make : PORSCHE
 Model : CARRERA
 Year : 86
 Mileage : 127918 Save Parts : NO
 VIN : WPOAB0916GS120538

N
 , CA

LABOR	AMOUNT
Charge battery.	.00
Charge battery.	
Charge battery.	
The battery will not take a charge.	
Test alternator output.Passed.	
R&R battery.	

PARTS	PRICE	QTY	AMOUNT
MTP-93 BATTERY	51.98	1	51.98

RECOMMENDATIONS AND TECHNICIANS NOTES

Windshield squirter contacts erratic.(lever)

Original Estimate : 55.88

Increases to Estimate					
Date	Time	OK'd By	Phone	Emp.	New Total

LABOR	.00
PARTS	51.98
SUBLETS	.00
SUB TOTAL	51.98
TAX	3.90
TOTAL	<u>55.88</u>

Parts & labor conditionally guaranteed 4,000 mi./ 90 days.

I hereby authorize DEJUNG MOTORSPORTS to perform the repair work listed above along with necessary materials. You and your employees may operate the above vehicle for purposes of testing, inspection, or delivery at my risk. An express mechanics lien is acknowledged on above vehicle to secure the amount of repairs. There to it is understood that this company assumes no responsibility for loss or damage by theft or fire to vehicles placed with them for storage, sale, repair, or while road testing.

Authorized by : _____ Date : _____

REPAIR ORDER

DeJung Motorsport
 459 Portal St.
 Cotati, CA 94931
 (707) 664-8002
 BAR #:A.C. 101025
 EPA# CAL000064429

R/O 8434
 Name :
 Date : 06/01/00
 License # : 1PCY741
 Make : PORSCHE
 Model : CARRERA
 Year : 86
 Mileage : 126533 Save Parts : NO
 VIN : WPOAB0916GS120538

, CA

LABOR	AMOUNT
Grind,old rear sway bar mounts at body,to remove.	241.50
Remove undercoat and paint from rear sway bar mount area.	
Weld in new style rear sway bar mounts,at body.	
Prime,paint and undercoat at rear sway bar mount area.	

PARTS	PRICE	QTY	AMOUNT
911 501 983 00 STABILIZE PLATE	69.06	2	138.12
abrasive wheel	6.00	1	6.00
cut off wheel	2.50	2	5.00

RECOMMENDATIONS AND TECHNICIANS NOTES

Windshield squirter contacts erratic.(lever)

Original Estimate : 401.80

Increases to Estimate					
Date	Time	OK'd By	Phone	Emp.	New Total

LABOR	241.50
PARTS	149.12
SUBLETS	.00
	.00
SUB TOTAL	390.62
TAX	11.18
TOTAL	401.80

Parts & labor conditionally guaranteed 4,000 mi./ 90 days.

I hereby authorize DEJUNG MOTORSPORTS to perform the repair work listed above along with necessary materials. You and your employees may operate the above vehicle for purposes of testing, inspection, or delivery at my risk. An express mechanics lien is acknowledged on above vehicle to secure the amount of repairs. Thereto it is understood that this company assumes no responsibility for loss or damage by theft or fire to vehicles placed with them for storage, sale, repair, or while road testing.

Authorized by : _____ Date : _____

REPAIR ORDER

deJung Motorsport
 459 Portal St.
 Cotati, CA 94931
 (707) 664-8002
 BAR#:A.C. 101025
 EPA# CAL000064429

R/O #: 8384
 Name : _____
 Date : 04/25/00
 License # : 1PCY741
 Make : PORSCHE
 Model : CARRERA
 Year : 86
 Mileage : 1252098 Save Parts : NO
 VIN : WPOAB0916GS120538

LABOR	AMOUNT
Oil service.	70.00
Inspect all brakes. R&R rear brake pads;	70.00

PARTS	PRICE	QTY	AMOUNT
OC 54 OIL FILTER	9.65	1	9.65
10 **ENGINE OIL(PTS.)	1.00	22	22.00
4602227 COPPER WASHER	0.38	2	0.76
01 TECHRON	6.95	1	6.95
03 WASHER SOLVENT	2.00	1	2.00
911 352 950 02 BRAKE PADS	34.24	1	34.24

RECOMMENDATIONS AND TECHNICIANS NOTES

Windshield squirter contacts erratic.(lever)

Original Estimate : 229.03

Increases to Estimate					
Date	Time	OK'd By	Phone	Emp.	New Total

LABOR	140.00
PARTS	75.60
SUBLETS	0.00
	0.00
HAZARDOUS MATERIALS	7.76
SUB TOTAL	223.36
TAX	5.67
TOTAL	\$ 229.03

Parts & labor conditionally guaranteed 4,000 mi./ 90 days.

I hereby authorize DEJUNG MOTORSPORTS to perform the repair work listed above along with necessary materials. You and your employees may operate the above vehicle for purposes of testing, inspection, or delivery at my risk. An express mechanics lien is acknowledged on above vehicle to secure the amount of repairs. Thereto it is understood that this company assumes no responsibility for loss or damage by theft or fire to vehicles placed with them for storage, sale, repair, or while road testing.

Authorized by : _____ Date : _____

REPAIR ORDER

deJung Motorsport
 459 Portal St.
 Cotati, CA 94931
 (707) 664-8002
 BAR #:A.C. 101025
 EPA# CAL000064429

R/O #8163
 Name :
 Date : 12/03/99
 License # : 1PCY741
 Make : PORSCHE
 Model : CARRERA
 Year : 86
 Mileage : 121335 Save Parts : NO
 VIN : WPOAB0916GS120538

, CA

LABOR	AMOUNT
Install rear seat, seatbelts. Modify as needed.	273.00

PARTS	PRICE	QTY	AMOUNT
964 555 511 seat belt set-rear-used	275.00	1	275.00
964 555 512 seat belt trim	8.35	1	8.35
seat belt trim	8.35	1	8.35
bolt cap	1.50	2	3.00

SUBLETS	AMOUNT
Freight: seatbelts	15.00

RECOMMENDATIONS AND TECHNICIANS NOTES

Windshield squirter contacts erratic. (lever)

Original Estimate : 604.80

Increases to Estimate					
Date	Time	OK'd By	Phone	Emp.	New Total

LABOR	273.00
PARTS	294.70
SUBLETS	15.00
	.00
SUB TOTAL	582.70
TAX	22.10
TOTAL	604.80

Parts & labor conditionally guaranteed 4,000 mi./ 90 days.

I hereby authorize DEJUNG MOTORSPORTS to perform the repair work listed above along with necessary materials. You and your employees may operate the above vehicle for purposes of testing, inspection, or delivery at my risk. An express mechanics lien is acknowledged on above vehicle to secure the amount of repairs. Thereto it is understood that this company assumes no responsibility for loss or damage by theft or fire to vehicles placed with them for storage, sale, repair, or while road testing.

Authorized by : _____ Date : _____

REPAIR ORDER

deJung Motorsport
 459 Portal St.
 Cotati, CA 94931
 (707) 664-8002
 BAR #:A.C. 101025
 EPA# CAL000064429

R/C 8142
 Name :
 Date : 11/12/99
 License # : 1PCY741
 Make : PORSCHE
 Model : CARRERA
 Year : 86
 Mileage : 120570 Save Parts : NO
 VIN : WPOAB0916GS120538

CA

LABOR	AMOUNT
Major service:	390.00
Tune up.	
Adjust valves.	
Full service.	

PARTS		PRICE	QTY	AMOUNT
PK 03	V/C GASKET KIT	29.90	1	29.90
OC 54	OIL FILTER	9.65	1	9.65
930 110 393 00	AIR FILTER	10.40	1	10.40
928 110 253 00	FUEL FILTER	17.50	1	17.50
03202	DISTRIBUTOR CAP	50.00	1	50.00
04163	ROTOR	15.27	1	15.27
B7EV	SPARK PLUG	7.79	6	46.74
GL5-S	GEAR OIL-SWEPKO 1/2 PT	3.00	12	36.00
10	**ENGINE OIL(PTS.)	1.00	22	22.00
03	WASHER SOLVENT	2.00	2	4.00
08	H.D. WASHER SOLVENT	2.00	1	2.00

RECOMMENDATIONS AND TECHNICIANS NOTES

Rear brakes next service.
 Windshield squirter contacts erratic.(lever)

Original Estimate : 659.48

Increases to Estimate					
Date	Time	OK'd By	Phone	Emp.	New Total

LABOR	390.00
PARTS	243.46
SUBLETS	0.00
	0.00
HAZARDOUS MATERIALS	7.76
SUB TOTAL	641.22
TAX	18.26
TOTAL	\$ 659.48

Parts & labor conditionally guaranteed 4,000 mi./ 90 days.

I hereby authorize DEJUNG MOTORSPORTS to perform the repair work listed above along with necessary materials. You and your employees may operate the above vehicle for purposes of testing, inspection, or delivery at my risk. An express mechanics lien is acknowledged on above vehicle to secure the amount of repairs. Thereto it is understood that this company assumes no responsibility for loss or damage by theft or fire to vehicles placed with them for storage, sale, repair, or while road testing.

Authorized by : _____ Date : _____

REPAIR ORDER

deJung Motorsport
 459 Portal St.
 Cotati, CA 94931
 (707) 664-8002
 BAR #:A.C. 101025
 EPA# CAL000064429

R/O 8033
 Name :
 Date : 09/03/99
 License # : 1PCY741
 Make : PORSCHE
 Model : CARRERA
 Year : 86
 Mileage : 117960 Save Parts : NO
 VIN : WPOAB0916GS120538

, CA

LABOR	AMOUNT
R&R alternator.	104.00
Install right seat, outside handle.	.00

PARTS	PRICE	QTY	AMOUNT
113 881 633E HANDLE	3.42	1	3.42
CLIP	.88	1	.88
911 603 120EX RMFG. ALTERNATOR	337.91	1	337.91

RECOMMENDATIONS AND TECHNICIANS NOTES

sweating.
 Windshield squirter contacts erratic.(lever)

Original Estimate : 471.88

Increases to Estimate					
Date	Time	OK'd By	Phone	Emp.	New Total

LABOR	104.00
PARTS	342.21
SUBLETS	.00
	.00
SUB TOTAL	446.21
TAX	25.67
TOTAL	<u>471.88</u>

Parts & labor conditionally guaranteed 4,000 mi./ 90 days.

I hereby authorize DEJUNG MOTORSPORTS to perform the repair work listed above along with necessary materials. You and your employees may operate the above vehicle for purposes of testing, inspection, or delivery at my risk. An express mechanics lien is acknowledged on above vehicle to secure the amount of repairs. Thereto it is understood that this company assumes no responsibility for loss or damage by theft or fire to vehicles placed with them for storage, sale, repair, or while road testing.

Authorized by : _____ Date : _____

REPAIR ORDER

deJung Motorsport
 459 Portal St.
 Cotati, CA 94931
 (707) 664-8002
 BAR #:A.C. 101025
 EPA# CAL000064429

R/O # : 7943
 Name :
 Lic. # : 1PCY741
 Make : PORSCHE
 Model : CARRERA
 Year : 86
 Mileage : 116623
 Date : 07/12/99
 Save Parts : NO
 Needed By : 5 P.M. TODAY
 P.O. Number:

, CA

LABOR	Mech.	Amount
Oil service.	SD	32.50
Inspect AC system for any visual leaks. None found.		
Charge AC system.	SD	65.00

PARTS	Price	Qty.	Amount
OC 54 OIL FILTER	9.65	1	9.65
10 **ENGINE OIL(PTS.)	1.00	22	22.00
4602227 COPPER WASHER	0.38	2	0.76
01 TECHRON	6.95	1	6.95
06 FREON	2.25	32	72.00

RECOMMENDATIONS AND TECHNICIANS NOTES

911 659 053 01 control unit \$182.45.
 965 624 151 00 fan at engine \$276.05.
 Oil hose, engine to oil thermostat is slightly sweating.
 Windshield squirter contacts erratic.(lever)

Original Estimate : 217.21

Increases to Estimate

DATE	TIME	Ok'd By	Emp.	NEW TOTAL

Total Labor	97.50
Total Parts	111.36
Total Sublets	0.00
	0.00
Sub Total	208.86
Tax	8.35
Total Amount	\$ 217.21

Parts & labor conditionally guaranteed 4,000 mi./ 90 days.

I hereby authorize deJung Motorsport to perform the above repair work along with necessary materials. You and your employees may operate the above vehicle for purposes of testing, inspection, or delivery at my risk. An express mechanics lien is acknowledged on above vehicle to secure the amount of repairs. Thereto it is understood that this company assumes no responsibility for loss or damage by theft or fire to vehicles placed with them for storage, sale, repair, or while road testing.

Authorized by: _____ Date _____

REPAIR ORDER

deJung Motorsport
 459 Portal St.
 Cotati, CA 94931
 (707) 664-8002
 BAR #:A.C. 101025
 EPA# CAL000064429

R/O # : 7694
 Name :
 Lic. # : 1PCY741
 Make : PORSCHE
 Model : CARRERA
 Year : 86
 Mileage : 110712
 Date : 02/11/99
 Save Parts : NO
 Needed By : 5 P.M. TODAY
 P.O. Number:

, CA

LABOR	Mech.	Amount
Oil service.	SD	65.00

PARTS	Price	Qty.	Amount
OC 54 OIL FILTER	9.65	1	9.65
10 **ENGINE OIL(PTS.)	1.00	22	22.00
4602227 COPPER WASHER	0.38	2	0.76
01 TECHRON	6.95	1	6.95

RECOMMENDATIONS AND TECHNICIANS NOTES

911 659 053 01 control unit \$182.45.
 965 624 151 00 fan at engine \$276.05.
 Oil hose,engine to oil thermostat is slightly sweating.
 Windshield squirter contacts erratic.(lever)

Original Estimate : 107.31

Increases to Estimate

DATE	TIME	Ok'd By	Emp.	NEW TOTAL

Total Labor	65.00
Total Parts	39.36
Total Sublets	0.00
Sub Total	104.36
Tax	2.95
Total Amount \$	107.31

Parts & labor conditionally guaranteed 4,000 mi./ 90 days.

I hereby authorize deJung Motorsport to perform the above repair work along with necessary materials. You and your employees may operate the above vehicle for purposes of testing, inspection, or delivery at my risk. An express mechanics lien is acknowledged on above vehicle to secure the amount of repairs. Thereto it is understood that this company assumes no responsibility for loss or damage by theft or fire to vehicles placed with them for storage, sale, repair, or while road testing.

Authorized by: _____ Date _____

REPAIR ORDER

deJung Motorsport
 459 Portal St.
 Cotati, CA 94931
 (707) 664-8002
 BAR #:A.C. 101025
 EPA# CAL000064429

R/O # : 7581
 Name :
 Lic. # : 1PCY741
 Make : PORSCHE
 Model : CARRERA
 Year : 86
 Mileage : 108022
 Date : 11/25/98
 Save Parts : NO
 Needed By : 5 P.M. TODAY
 P.O. Number:

CA

LABOR

	Mech.	Amount
Charge battery.		
Load test battery.Passed.		
Test alternator output.Passed.		
Test for any excessive electrical drains. none found.		
R&R battery.	SD	16.25
Check out erratic shifting.3rd and 5th is the problem area.		
R&R shift coupling at the transmission.	SD	32.50
Check out windshield squirter.		
R&R left squirter nozzle assembly.		
Replace hoses at left squirter.See below.	SD	58.50
R&R both front hood shocks.	SD	16.25
R&R both sunroof cables.Clean and lube both cable tracks.Straighten both front slider clip mounts.Adjust front level of panel.	SD	169.00

PARTS

		Price	Qty.	Amount
MTP-93	BATTERY	103.95	1	103.95
BTP	BATTERY TERMINAL PROTECTORS	0.27	2	0.54
911 424 024 04	SHIFT COUPLING	82.50	1	82.50
928 628 077 00	WINDSHIELD NOZZLE	29.00	1	29.00
N 100 020 01	WINDSHIELD HOSE CLMP	1.10	5	5.50
911 511 331 01	HOOD SHOCK	18.30	2	36.60
964 564 143 00	SUNROOF CABLE - LEFT	46.70	1	46.70
964 564 144 00	SUNROOF CABLE - RIGHT	46.70	1	46.70
	WINDSHIELD SQ HOSE	2.00	1	2.00

RECOMMENDATIONS AND TECHNICIANS NOTES

REPAIR ORDER

Pg.:2

deJung Motorsport
459 Portal St.
Cotati, CA 94931
(707) 664-8002
BAR #:A.C. 101025
EPA# CAL000064429

R/O # : 7581
Name :
Lic. # : 1PCY741
Make : PORSCHE
Model : CARRERA
Year : 86
Mileage : 108022
Date : 11/25/98
Save Parts : NO
Needed By : 5 P.M. TODAY
P.O. Number:

CA

911 659 053 01 control unit \$182.45.
965 624 151 00 fan at engine \$276.05.
Oil hose, engine to oil thermostat is slightly sweating.
Windshield squirter contacts cratic.(lover)

Original Estimate : 672.50

Increases to Estimate

DATE	TIME	Ok'd By	Emp.	NEW TOTAL

Total Labor	292.50
Total Parts	353.49
Total Sublets	0.00
	0.00
Sub Total	645.99
Tax	26.51
Total Amount \$	672.50

Parts & labor conditionally guaranteed 4,000 mi./ 90 days.

I hereby authorize deJung Motorsport to perform the above repair work along with necessary materials. You and your employees may operate the above vehicle for purposes of testing, inspection, or delivery at my risk. An express mechanics lien is acknowledged on above vehicle to secure the amount of repairs. Thereto it is understood that this company assumes no responsibility for loss or damage by theft or fire to vehicles placed with them for storage, sale, repair, or while road testing.

Authorized by: _____ Date _____

REPAIR ORDER

deJung Motorsport
459 Portal St.
Cotati, CA 94931
(707) 664-8002
BAR #:A.C. 101025
EPA# CAL000064429

R/O # : 7426
Name :
Lic. # : 1PCY741
Make : PORSCHE
Model : CARRERA
Year : 86
Mileage : 105393
Date : 08/28/98
Save Parts : NO
Needed By : 5 P.M. TODAY
P.O. Number:

CA

LABOR

Oil service.
Check out erratic steering/stiff steering.
See Steve.

Mech.

SD

Amount

65.00

PARTS

OC 54	OIL FILTER
10	**ENGINE OIL(PTS.)
4602227	COPPER WASHER
01	TECHRON

Price	Qty.	Amount
9.65	1	9.65
1.00	22	22.00
0.38	2	0.76
6.95	1	6.95

RECOMMENDATIONS AND TECHNICIANS NOTES

911 659 053 01 control unit \$182.45.
965 624 151 00 fan at engine \$276.05.
Oil hose,engine to oil thermostat is slightly sweating.

Original Estimate : 107.31

Increases to Estimate

DATE	TIME	Ok'd By	Emp.	NEW TOTAL

Total Labor	65.00
Total Parts	39.36
Total Sublets	0.00
	0.00
Sub Total	104.36
Tax	2.95
Total Amount	\$ 107.31

Parts & labor conditionally guaranteed 4,000 mi./ 90 days.

I hereby authorize **deJung Motorsport** to perform the above repair work along with necessary materials. You and your employees may operate the above vehicle for purposes of testing, inspection, or delivery at my risk. An express mechanics lien is acknowledged on above vehicle to secure the amount of repairs. Thereto it is understood that this company assumes no responsibility for loss or damage by theft or fire to vehicles placed with them for storage, sale, repair, or while road testing.

Authorized by: _____ Date _____

REPAIR ORDER

deJung Motorsport
 459 Portal St.
 Cotati, CA 94931
 (707) 664-8002
 BAR #:A.C. 101025
 EPA# CAL000064429

R/O # : 7161
 Name :
 Lic. # : 1PCY741
 Make : PORSCHE
 Model : CARRERA
 Year : 86
 Mileage : 100224
 Date : 03/23/98
 Save Parts : NO
 Needed By : 5 P.M. TODAY
 P.O. Number:

CA

LABOR	Mech.	Amount
Oil service.	SD	65.00
R&R left fog light bulb.		
Check out erratic electrical problems.		
Check grounds.		
R&R squirter check valves. Clear squirters and		
R&R "T"s as needed.	SD	65.00

PARTS	Price	Qty.	Amount
H3 BULB	7.30	1	7.30
OC 54 OIL FILTER	9.65	1	9.65
10 **ENGINE OIL(PTS.)	1.00	22	22.00
4602227 COPPER WASHER	0.38	2	0.76
01 TECHRON	6.95	1	6.95
03 WASHER SOLVENT	2.00	2	4.00
08 H.D. WASHER SOLVENT	2.00	1	2.00
477 955 481 CHECK VALVE	3.10	4	12.40
"T" VALVE	2.00	3	6.00

RECOMMENDATIONS AND TECHNICIANS NOTES

911 659 053 01 control unit \$182.45.
 965 624 151 00 fan at engine \$276.05.
 Oil hose, engine to oil thermostat is slightly sweating.

Original Estimate : 206.39					Total Labor	130.00
Increases to Estimate					Total Parts	71.06
DATE	TIME	Ok'd By	Emp.	NEW TOTAL	Total Sublets	0.00
						0.00
					Sub Total	201.06
					Tax	5.33
					Total Amount	\$ 206.39

Parts & labor conditionally guaranteed 4,000 mi./ 90 days.

I hereby authorize deJung Motorsport to perform the above repair work along with necessary materials. You and your employees may operate the above vehicle for purposes of testing, inspection, or delivery at my risk. An express mechanics lien is acknowledged on above vehicle to secure the amount of repairs. Thereto it is understood that this company assumes no responsibility for loss or damage by theft or fire to vehicles placed with them for storage, sale, repair, or while road testing.

Authorized by: _____ Date _____

REPAIR ORDER

deJung Motorsport
 459 Portal St.
 Cotati, CA 94931
 (707) 664-8002
 BAR #:A.C. 101025
 EPA# CAL000064429

R/O # : 6868
 Name :
 Lic. # : 1PCY741
 Make : PORSCHE
 Model : CARRERA
 Year : 86
 Mileage : 93904
 Date : 08/01/97
 Save Parts : NO
 Needed By : 5 P.M. TODAY
 P.O. Number:

, CA

LABOR	Mech.	Amount
Major service:		
Tune up.		
Adjust valves.		
Full service.	SD	360.00
Hydraulic system flush.	SD	42.00
R&R rear hood shock.	SD	6.00
Check out non op left squirters. See below.		
R&R AC belt.		
Check out engine oil leak. See below.		

PARTS	Description	Price	Qty.	Amount
PK 03	V/C GASKET KIT	29.90	1	29.90
10	**ENGINE OIL(PTS.)	1.00	23	23.00
KL 21	FUEL FILTER	17.50	1	17.50
OC 54	OIL FILTER	9.28	1	9.28
LX 77	AIR FILTER	13.35	1	13.35
03202	DISTRIBUTOR CAP	49.85	1	49.85
04163	ROTOR	15.05	1	15.05
B7EV	SPARK PLUG	6.90	6	41.40
01	TECHRON	6.95	1	6.95
GL5	GEAR OIL (1/2 PINT)	0.90	12	10.80
03	WASHER SOLVENT	2.00	1	2.00
08	H.D. WASHER SOLVENT	2.00	1	2.00
5007	BULB	1.72	1	1.72
05	BRAKE FLUID	0.35	24	8.40
928 628 623 00	WIPER ARM CAP	0.75	1	0.75
12.5X1150	BELT	16.80	1	16.80
911 512 331 02	STRUT	30.07	1	30.07

RECOMMENDATIONS AND TECHNICIANS NOTES

REPAIR ORDER

Pg.:2

deJung Motorsport
459 Portal St.
Cotati, CA 94931
(707) 664-8002
BAR #:A.C. 101025
EPA# CAL000064429

R/O # : 6868
Name :
Lic. # : 1PCY741
Make : PORSCHE
Model : CARRERA
Year : 86
Mileage : 93904
Date : 08/01/97
Save Parts : NO
Needed By : 5 P.M. TODAY
P.O. Number:

. CA

RECOMMENDATIONS AND TECHNICIANS NOTES

911 659 053 01 control unit \$182.45.
965 624 151 00 fan at engine \$276.05.
Needs both left squirter check valves.
Oil hose,engine to oil thermostat is slightly sweating.

Original Estimate : 707.73

Increases to Estimate

DATE	TIME	Ok'd By	Emp.	NEW TOTAL

Total Labor	408.00
Total Parts	278.82
Total Sublets	0.00
	0.00
Sub Total	686.82
Tax	20.91
Total Amount	\$ 707.73

Parts & labor conditionally guaranteed 4,000 mi./ 90 days.

I hereby authorize deJung Motorsport to perform the above repair work along with necessary materials. You and your employees may operate the above vehicle for purposes of testing, inspection, or delivery at my risk. An express mechanics lien is acknowledged on above vehicle to secure the amount of repairs. Thereto it is understood that this company assumes no responsibility for loss or damage by theft or fire to vehicles placed with them for storage, sale, repair, or while road testing.

Authorized by: _____ Date _____

REPAIR ORDER

deJung Motorsport
 459 Portal St.
 Cotati, CA 94931
 (707) 664-8002
 BAR #:A.C. 101025
 EPA# CAL000064429

R/O # : 6544
 Name :
 Lic. # : 1PCY741
 Make : PORSCHE
 Model : CARRERA
 Year : 86
 Mileage : 88582
 Date : 01/28/97
 Save Parts : NO
 Needed By : 5 P.M. TODAY
 P.O. Number:

, CA

LABOR

Mech.	Amount
SD	420.00
SD	600.00
SD	60.00
SD	60.00
SD	30.00

PARTS

		Price	Qty.	Amount
OC 54	OIL FILTER	9.65	1	9.65
10	**ENGINE OIL(PTS.)	1.00	22	22.00
4602227	COPPER WASHER	0.38	2	0.76
GL5	GEAR OIL (1/2 PINT)	0.90	12	10.80
999 052 043 00	PINION SHAFT BEARING	104.00	1	104.00
999 110 146 00	PINION SHAFT BEARING	133.00	1	133.00
915 300 911 01	GASKET SET	38.00	1	38.00
915 302 241 14	GEAR TEETH	95.00	1	95.00
915 302 301 06	SYNCHRONIZER RING	23.00	1	23.00
930 302 411 02	OPERATING SLEEVE	123.00	1	123.00
915 302 282 00	PINION SHAFT NUT	7.83	1	7.83
915 116 900 00	CLUTCH KIT	417.00	1	417.00
930 102 042 00	PILOT BEARING	28.00	1	28.00
999 113 426 40	CRANKSHAFT SEAL	25.25	1	25.25
915 116 712 01	CLUTCH RELEASE FORK	66.00	1	66.00
915 302 301 04	SYNCHRONIZER RING	27.60	1	27.60

REPAIR ORDER

Pg.: 2

deJung Motorsport
 459 Portal St.
 Cotati, CA 94931
 (707) 664-8002
 BAR #: A.C. 101025
 EPA# CAL000064429

R/O # : 6544
 Name :
 Lic. # : 1PCY741
 Make : PORSCHE
 Model : CARRERA
 Year : 86
 Mileage : 88582
 Date : 01/28/97
 Save Parts : NO
 Needed By : 5 P.M. TODAY
 P.O. Number:

, CA

PARTS

USED		Price	Qty.	Amount
	SHIFT SUPPORT FORK	50.00	1	50.00
901 302 242 03	GEAR TEETH	95.00	1	95.00
915 302 281 00	NUT	11.30	1	11.30
915 302 311 01	SNAP RING	8.35	1	8.35
911 302 402 20	3 POINT GUIDE SLEEVE	200.26	1	200.26
915 301 139 00	TO SHAFT SEAL	1.93	1	1.93
999 707 172 40	OIL PISTON "O"RING	1.45	1	1.45
911 606 230 00	OP SWITCH	11.78	1	11.78

SUBLETS

	Amount
Resurface flywheel.	55.00

RECOMMENDATIONS AND TECHNICIANS NOTES

911 659 053 01 control unit \$182.45.
 965 624 151 00 fan at engine \$276.05.
 Washers are non op.

Original Estimate : 1170.00

Increases to Estimate

DATE	TIME	Ok'd By	Emp.	NEW TOTAL

Total Labor	1,170.00
Total Parts	1,510.96
Total Sublets	55.00
	0.00
Sub Total	2735.96
Tax	113.32
Total Amount	\$ 2,849.28

Parts & labor conditionally guaranteed 4,000 mi./ 90 days.

I hereby authorize **deJung Motorsport** to perform the above repair work along with necessary materials. You and your employees may operate the above vehicle for purposes of testing, inspection, or delivery at my risk. An express mechanics lien is acknowledged on above vehicle to secure the amount of repairs. Thereto it is understood that this company assumes no responsibility for loss or damage by theft or fire to vehicles placed with them for storage, sale, repair, or while road testing.

Authorized by: _____ Date _____

REPAIR ORDER

deJung Motorsport
 459 Portal St.
 Cotati, CA 94931
 (707) 664-8002
 BAR #:A.C. 101025
 EPA# CAL000064429

R/O # : 6227
 Name :
 Lic. # : 1PCY741
 Make : PORSCHE
 Model : CARRERA
 Year : 86
 Mileage : 84796
 Date : 07/19/96
 Save Parts : NO
 Needed By : 5 P.M. TODAY
 P.O. Number:

CA

LABOR

	Mech.	Amount
Oil service.	SD	60.00
Check out AC system for leaks. None found.		
Charge AC system.	SD	60.00
R&R drivers window switch.		

PARTS

	Price	Qty.	Amount
911 613 621 03 WINDOW SWITCH	20.38	1	20.38
06 FREON	1.70	31	52.70
OC 54 OIL FILTER	9.65	1	9.65
4602227 COPPER WASHER	0.38	2	0.76
10 **ENGINE OIL(PTS.)	1.00	22	22.00
01 TECHRON	6.95	1	6.95

RECOMMENDATIONS AND TECHNICIANS NOTES

911 659 053 01 control unit \$182.45.
 965 624 151 00 fan at engine \$276.05.
 1 Gear tooth on drain plug.
 Washers are non op.

Original Estimate : 240.87

Increases to Estimate

DATE	TIME	Ok'd By	Emp.	NEW TOTAL

Total Labor	120.00
Total Parts	112.44
Total Sublets	0.00
	0.00
Sub Total	232.44
Tax	8.43
Total Amount \$	240.87

Parts & labor conditionally guaranteed 4,000 mi./ 90 days.

I hereby authorize deJung Motorsport to perform the above repair work along with necessary materials. You and your employees may operate the above vehicle for purposes of testing, inspection, or delivery at my risk. An express mechanics lien is acknowledged on above vehicle to secure the amount of repairs. Thereto it is understood that this company assumes no responsibility for loss or damage by theft or fire to vehicles placed with them for storage, sale, repair, or while road testing.

Authorized by: _____ Date _____

REPAIR ORDER

deJung Motorsport
 459 Portal St.
 Cotati, CA 94931
 (707) 664-8002
 BAR #:A.C. 101025
 EPA# CAL000064429

R/O # : 5970
 Name :
 Lic. # : 1PCY741
 Make : PORSCHE
 Model : CARRERA
 Year : 86
 Mileage : 80792
 Date : 03/15/96
 Save Parts : NO
 Needed By : 5 P.M. TODAY
 P.O. Number:

, CA

LABOR

Mech.

Amount

Change trans oil.	SD	12.00
R&R left cam oil line.	SD	66.00
R&R oxygen sensor.	SD	36.00
R&R right headlamp.	SD	15.00

PARTS

		Price	Qty.	Amount
4601216	COPPER WASHER	0.32	3	0.96
H6017	HEADLAMP	23.95	1	23.95
GL5	GEAR OIL (1/2 PINT)	0.90	12	10.80
930 107 347 05	CAM OIL LINE	32.42	1	32.42
965 606 126 01	OXYGEN SENSOR	141.30	1	141.30

RECOMMENDATIONS AND TECHNICIANS NOTES

911 659 053 01 control unit \$182.45.
 965 624 151 00 fan at engine \$276.05.
 1 Gear tooth on drain plug.
 Washers are non op.

Original Estimate : 354.14

Increases to Estimate

DATE	TIME	Ok'd By	Emp.	NEW TOTAL

Total Labor	129.00
Total Parts	209.43
Total Sublets	0.00
	0.00
Sub Total	338.43
Tax	15.71
Total Amount	\$ 354.14

Parts & labor conditionally guaranteed 4,000 mi./ 90 days.

I hereby authorize deJung Motorsport to perform the above repair work along with necessary materials. You and your employees may operate the above vehicle for purposes of testing, inspection, or delivery at my risk. An express mechanics lien is acknowledged on above vehicle to secure the amount of repairs. Thereto it is understood that this company assumes no responsibility for loss or damage by theft or fire to vehicles placed with them for storage, sale, repair, or while road testing.

Authorized by: _____ Date _____

REPAIR ORDER

deJung Motorsport
 459 Portal St.
 Cotati, CA 94931
 (707) 664-8002
 BAR #:A.C. 101025
 EPA# CAL000064429

R/O # : 5940
 Name :
 Lic. # : 1PCY741
 Make : PORSCHE
 Model : CARRERA
 Year : 86
 Mileage : 79961
 Date : 02/29/96
 Save Parts : NO
 Needed By : 5 P.M. TODAY
 P.O. Number:

CA

LABOR	Mech.	Amount
Check out poor running.Adjust fuel injection from 4.0% to 1.0%	SD	45.00
Oil service.	SD	60.00

PARTS	Price	Qty.	Amount
OC 54 OIL FILTER	9.65	1	9.65
10 **ENGINE OIL(PTS.)	1.00	22	22.00
4602227 COPPER WASHER	0.38	1	0.38
01 TECHRON	6.95	1	6.95
03 WASHER SOLVENT	2.00	1	2.00

RECOMMENDATIONS AND TECHNICIANS NOTES

911 659 053 01 control unit \$182.45.
 965 624 151 00 fan at engine \$276.05.
 1 Gear tooth on drain plug.
 Washers are non op.
 Left oil line.

*1) replace oil line
 2) replace O₂ sen. (230)*

Original Estimate : 149.05

Increases to Estimate

DATE	TIME	Ok'd By	Emp.	NEW TOTAL

Total Labor	105.00
Total Parts	40.98
Total Sublets	0.00
	0.00
Sub Total	145.98
Tax	3.07
Total Amount \$	149.05

Parts & labor conditionally guaranteed 4,000 mi./ 90 days.

I hereby authorize deJung Motorsport to perform the above repair work along with necessary materials. You and your employees may operate the above vehicle for purposes of testing, inspection, or delivery at my risk. An express mechanics lien is acknowledged on above vehicle to secure the amount of repairs. Thereto it is understood that this company assumes no responsibility for loss or damage by theft or fire to vehicles placed with them for storage, sale, repair, or while road testing.

Authorized by: _____ Date _____

REPAIR ORDER

deJung Motorsport
 459 Portal St.
 Cotati, CA 94931
 (707) 664-8002
 BAR #: A.C. 101025
 EPA# CAL000064429

R/O # : 5605
 Name :
 Lic. # : 1PCY741
 Make : PORSCHE
 Model : CARRERA
 Year : 86
 Mileage : 75556
 Date : 09/14/95
 Save Parts : NO
 Needed By : 5 P.M. TODAY
 P.O. Number:

, CA

LABOR	Mech.	Amount
R&I gear shifter assembly. Weld gearshaft lever.	SD	114.00
Drain and fill gear oil. Check for any gear teeth. None found.	SD	12.00

PARTS	Price	Qty.	Amount
GL5 GEAR OIL (1/2 PINT)	0.90	12	10.80

RECOMMENDATIONS AND TECHNICIANS NOTES

911 659 053 01 control unit \$182.45.
 965 624 151 00 fan at engine \$276.05.
 1 Gear tooth on drain plug.
 Washers are non op.

Original Estimate : 114.00					Total Labor	126.00
Increases to Estimate					Total Parts	10.80
DATE	TIME	Ok'd By	Emp.	NEW TOTAL	Total Sublets	0.00
						0.00
					Sub Total	136.80
					Tax	0.81
					Total Amount	\$ 137.61

Parts & labor conditionally guaranteed 4,000 mi./ 90 days.
 I hereby authorize **deJung Motorsport** to perform the above repair work along with necessary materials. You and your employees may operate the above vehicle for purposes of testing, inspection, or delivery at my risk. An express mechanics lien is acknowledged on above vehicle to secure the amount of repairs. Thereto it is understood that this company assumes no responsibility for loss or damage by theft or fire to vehicles placed with them for storage, sale, repair, or while road testing.

Authorized by: _____ Date _____

REPAIR ORDER

deJung Motorsport
 459 Portal St.
 Cotati, CA 94931
 (707) 664-8002
 BAR #:A.C. 101025
 EPA# CAL000064429

R/O # : 5509
 Name :
 Lic. # : 1PCY741
 Make : PORSCHE
 Model : CARRERA
 Year : 86
 Mileage : 75,158
 Date : 08/04/95
 Save Parts : NO
 Needed By : 5 P.M. TODAY
 P.O. Number:

, CA

LABOR

	Mech.	Amount
Major service:		
Tune up.		
Adjust valves.		
Full service.		
R&R 1 spark plug connector.	CB	360.00

PARTS

	Price	Qty.	Amount
PK 03 V/C GASKET KIT	29.90	1	29.90
10 **ENGINE OIL(PTS.)	1.00	23	23.00
KL 21 FUEL FILTER	27.68	1	27.68
OC 54 OIL FILTER	9.28	1	9.28
LX 77 AIR FILTER	13.15	1	13.15
03202 DISTRIBUTOR CAP	49.85	1	49.85
04163 ROTOR	15.05	1	15.05
B7EV SPARK PLUG	9.90	6	59.40
01 TECHRON	6.95	1	6.95
911 602 315 00 SPARK PLUG CONNECTOR	28.50	1	28.50
GL5 GEAR OIL (1/2 PINT)	0.90	12	10.80

RECOMMENDATIONS AND TECHNICIANS NOTES

911 659 053 01 control unit \$182.45.
 965 624 151 00 fan at engine \$276.05.
 1 Gear tooth on drain plug.
 Washers are non op.

Original Estimate : 654.08

Increases to Estimate

DATE	TIME	Ok'd By	Emp.	NEW TOTAL

Total Labor	360.00
Total Parts	273.56
Total Sublets	0.00
	0.00
Sub Total	633.56
Tax	20.52
Total Amount \$	654.08

Parts & labor conditionally guaranteed 4,000 mi./ 90 days.

I hereby authorize deJung Motorsport to perform the above repair work along with necessary materials. You and your employees may operate the above vehicle for purposes of testing, inspection, or delivery at my risk. An express mechanics lien is acknowledged on above vehicle to secure the amount of repairs. Thereto it is understood that this company assumes no responsibility for loss or damage by theft or fire to vehicles placed with them for storage, sale, repair, or while road testing.

Authorized by: _____ Date _____

VALLEY TIRE & BRAKE

1688 PINER ROAD, SANTA ROSA, CALIFORNIA 95403
(707) 544-3420 • (800) 300-6696

**TIRES • BRAKES • ALIGNMENT • STEERING
SUSPENSION • STRUTS • SHOCKS
PROBLEM SOLVING**

— 25 Years of Service —

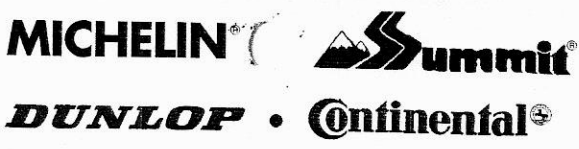

INVOICE
EPA #CAL000072981
BAR #AJ36777R

INVOICE DATE	CUST. NO.	ORDER NO.	PAGE	INVOICE NO.
03/16/95	999999	9485	1	8568

License: 1PCY741
Mileage: 070,782 Yr: 86 Mk: PORSC Md1: CARRE

OLD TO

SHIP TO

SEBASTOPOL, CA 95473

PURCHASE ORD. NO.	SALES PERSON	MAIN PHONE	OTHER PHONE	SHIP VIA
	JM3	4		

Cash

ITEM NO.	DESCRIPTION	QTY. ORDERED	QTY. SHIPPED	F.E.T.	PRICE	NET EXTENSION
PPFE	PERFO TB-1126 911 26MM REAR TORSION	1	1		250.00	250.00
PPFE	WIDE 930 34703101 TURBO TIE ROD EN	1	1		200.00	200.00
RKLBR	* INSTALL REAR TORSION BARS AND INSTA *TURBO TIE ROD ENDS. *	1	1		240.00	240.00
WA	FOUR WHEEL ALIGNMENT; *ROAD TEST VEHICLE, COMPLETE CENTER *THRUST FOUR WHEEL ALIGNMENT, FINAL *ROAD TEST. *INCLUDES LEVELING TO CUSTOMER *SPECIFICATIONS.	1	1		150.00	150.00

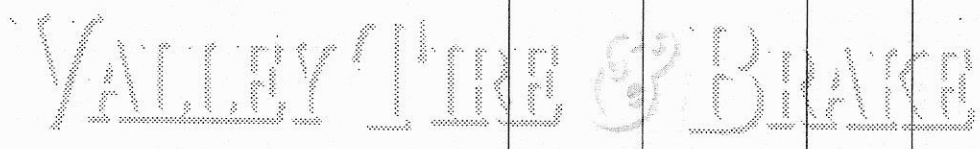

-----LOANER N/C-----
ASK ABOUT ROAD HAZARD COVERAGE
DISCARD.....SAVE.....OLD PARTS

ORIGINAL ESTIMATE OF REPAIRS: \$ _____ PLUS TAX
Includes all parts, labor, handling and diagnosis. If on closer analysis it is found that additional repairs are necessary, you will be contacted for authorization pursuant to Section 3, Chapter 20.3, Article 3, Sec. 9884.9 of the California Business and Professions Code. All parts are new unless specified otherwise.
If your automobile is returned to customer before authorized service is performed, diagnostic and handling charge will be made.
Because of the extent of the teardown and inspection, the vehicle may not perform well as before.
Please read and understand the above estimate and terms. I authorize service to be performed, including sublet work, road test and acknowledge receipt of this estimate.

Date:	By:	Date:	By:
Phone #:	Reason:	Phone #:	Reason:
Revised Est. Amount: \$	Revised Est. Amount: \$	I acknowledge notice and oral approval of an increase in the original estimate price to the amount noted above.	
<input checked="" type="checkbox"/> X			

SubTot Parts:	450.00
SubTot Labor:	390.00
Tax 7.500% :	33.75
Inv Total :	873.75

ST SIG _____ DATE _____
WARRANTY ON PARTS AND LABOR ARE 90 DAYS OR 3,000 MILES UNLESS OTHERWISE NOTED ON INVOICE. INSTALLED PARTS ARE NOT WARRANTIED BEYOND THAT GIVEN BY MANUFACTURER. ALL WARRANTIED ITEMS MUST BE RETURNED WITH INVOICE WITHIN WARRANTY PERIOD FOR EXCHANGE OR CREDIT. ANY WARRANTY, PARTS OR LABOR HONORED ONLY AT VALLEY TIRE & BRAKE, SANTA ROSA, CALIFORNIA.

REPAIR ORDER

deJung Motorsport
 459 Portal St.
 Cotati, CA 94931
 (707) 664-8002
 BAR #: A.C. 101025
 EPA# CAL000064429

R/O # : 5162
 Name :
 Lic. # : 1PCY741
 Make : PORSCHE
 Model : CARRERA
 Year : 86
 Mileage : 70347
 Date : 02/27/95
 Save Parts : NO
 Needed By : 5 P.M. TODAY
 P.O. Number:

, CA

LABOR

	Mech.	Amount
R&R window switch at right door.	SD	6.00
R&R PCV valve.	SD	6.00
Oil service.	SD	60.00

PARTS

	Price	Qty.	Amount
OC 54 OIL FILTER	9.51	1	9.51
10 **ENGINE OIL(PTS.)	1.00	22	22.00
4602227 COPPER WASHER	0.38	2	0.76
01 TECHRON	6.95	1	6.95
2-9201 PCV VALVE	6.00	1	6.00
911 613 621 03 WINDOW SWITCH	19.85	1	19.85

RECOMMENDATIONS AND TECHNICIANS NOTES

965 624 151 00 fan at engine \$276.05.

Original Estimate : 141.95

Increases to Estimate

DATE	TIME	Ok'd By	Emp.	NEW TOTAL

Total Labor	72.00
Total Parts	65.07
Total Sublets	0.00
	0.00
Sub Total	137.07
Tax	4.88
Total Amount	\$ 141.95

Parts & labor conditionally guaranteed 4,000 mi./ 90 days.

I hereby authorize deJung Motorsport to perform the above repair work along with necessary materials. You and your employees may operate the above vehicle for purposes of testing, inspection, or delivery at my risk. An express mechanics lien is acknowledged on above vehicle to secure the amount of repairs. Thereto it is understood that this company assumes no responsibility for loss or damage by theft or fire to vehicles placed with them for storage, sale, repair, or while road testing.

Authorized by: _____ Date _____

REPAIR ORDER

deJung Motorsport
 459 Portal St.
 Cotati, CA 94931
 (707) 664-8002
 BAR #: A.C. 101025
 EPA# CAL000064429

R/O # : 4923
 Name :
 Lic. # : 1PCY741
 Make : PORSCHE
 Model : CARRERA
 Year : 86
 Mileage : 67235
 Date : 11/03/94
 Save Parts : NO
 Needed By : 5 P.M. TODAY
 P.O. Number:

, CA

LABOR

R&R right camshaft oil line.
 Adjust alternator belt.

Mech.	Amount
SD	120.00
SD	6.00

PARTS

930 107 348 11 CAM OIL LINE

Price	Qty.	Amount
29.35	1	29.35

RECOMMENDATIONS AND TECHNICIANS NOTES

965 624 151 00 fan at engine \$276.05.
~~Right cam oil line.~~

Original Estimate : 157.55

Increases to Estimate

DATE	TIME	Ok'd By	Emp.	NEW TOTAL

Total Labor	126.00
Total Parts	29.35
Total Sublets	0.00
	0.00
Sub Total	155.35
Tax	2.20
Total Amount \$	157.55

Parts & labor conditionally guaranteed 4,000 mi./ 90 days.

I hereby authorize deJung Motorsport to perform the above repair work along with necessary materials. You and your employees may operate the above vehicle for purposes of testing, inspection, or delivery at my risk. An express mechanics lien is acknowledged on above vehicle to secure the amount of repairs. Thereto it is understood that this company assumes no responsibility for loss or damage by theft or fire to vehicles placed with them for storage, sale, repair, or while road testing.

Authorized by: _____ Date _____

REPAIR ORDER

deJung Motorsport
 459 Portal St.
 Cotati, CA 94931
 (707) 664-8002
 BAR #: A.C. 101025
 EPA# CAL000064429

R/O # : 4890
 Name :
 Lic. # : 1PCY741
 Make : PORSCHE
 Model : CARRERA
 Year : 86
 Mileage : 66343
 Date : 10/20/94
 Save Parts : NO
 Needed By : 5 P.M. TODAY
 P.O. Number:

CA

LABOR

Check out non op floor fans. Trace problem to a grounded #2 fan speed wire and a lack of power at the #3 fan speed relay. Rewir as needed to correct.
 Oil service.

Mech.	Amount
SD	110.00
SD	55.00

PARTS

		Price	Qty.	Amount
OC 54	OIL FILTER	9.28	1	9.28
10	**ENGINE OIL(PTS.)	1.00	22	22.00
4602227	COPPER WASHER	0.38	2	0.76
01	TECHRON	6.95	1	6.95
ESP-912	ELECT 3 WAY CONN	3.75	2	7.50

RECOMMENDATIONS AND TECHNICIANS NOTES

965 624 151 00 fan at engine \$276.05.

*Right Cam cover starting to leak oil ~\$ 150
 Oil line
 Nail in Left F fire*

Original Estimate : 214.98

Increases to Estimate

DATE	TIME	Ok'd By	Emp.	NEW TOTAL

Total Labor	165.00
Total Parts	46.49
Total Sublets	0.00
Sub Total	211.49
Tax	3.49
Total Amount \$	214.98

Parts & labor conditionally guaranteed 4,000 mi./ 90 days.

I hereby authorize deJung Motorsport to perform the above repair work along with necessary materials. You and your employees may operate the above vehicle for purposes of testing, inspection, or delivery at my risk. An express mechanics lien is acknowledged on above vehicle to secure the amount of repairs. Thereto it is understood that this company assumes no responsibility for loss or damage by theft or fire to vehicles placed with them for storage, sale, repair, or while road testing.

Authorized by: _____ Date _____

DAMAGE REPORT
 Date: 07/06/94
 AJ134971

D.R. 00002685
 Estimator: SA

ANDERSON'S AUTO BODY
 EXCELLENCE IN AUTO BODY REPAIR
 825 PETALUMA BLVD. N.
 PETALUMA, CA 94952-
 (707) 762-4797

VEHICLE OWNER: _____

DAY PHONE: (707) _____
 OTHER PHONE: (707) - - -

ADDRESS: , PETALUMA, CA 94952

YEAR: 86
 STYLE:
 VIN:

MAKE: POR
 COLOR:
 PROD DATE: /

MODEL:
 LICENSE:
 MILEAGE: 0

INSURANCE CO.:
 ADJUSTER:

PHONE: - - -
 CLAIM NO.:
 DED.: 0.00

NO.	REPLACE REPAIR	DESCRIPTION OF DAMAGE	QTY	PARTS PRICE	LBR HRS	PAINT HRS	MISC
1		R&I RT H/L	1	0.00	0.3	0.0	
2		R&I EXT FRONT & BUMP END	1	0.00	0.5	0.0	
3	Repair	RT FENDER	1	0.00	4.5	2.5	
4	Repair	FRONT VALANCE	1	0.00	1.0	1.5	
5		COLOR MATCH	1	0.00	0.0	0.5	
6		CLEAR COAT	1	0.00	0.0	1.0	
7		TEX COAT	1	0.00	0.0	0.5	
Subtotals ==>				0.00	6.3	6.0	0.00

PAID SA 7/12/94

Labor 6.3 hrs @ 49.00/hr 308.70
 Paint 6.0 hrs @ 49.00/hr 294.00
 Paint Supplies 138.00
 Subtotal \$ 740.70

 GRAND TOTAL \$ 740.70

I hereby authorize the above repair work to be done along with the necessary materials. You and your employees may operate the above vehicle for purposes of testing, inspection or delivery at my risk. An express mechanics lien is acknowledged on the above vehicle to secure the amount of repairs thereto.

SIGNED x _____

VALLEY TIRE & BRAKE

1688 PINER ROAD, SANTA ROSA, CALIFORNIA 95403
 (707) 544-3420 • (800) 300-6696

MICHELIN®

Summit®

INVOICE

DUNLOP • Continental®

EPA #CAL000072981
 BAR #AJ36777R

**TIRES • BRAKES • ALIGNMENT • STEERING
 SUSPENSION • STRUTS • SHOCKS
 PROBLEM SOLVING**

— 25 Years of Service —

INVOICE DATE	CUST. NO.	ORDER NO.	PAGE	INVOICE NO.
06/29/94	999999	4104	1	Time in 5:04 PM
License: 1PCY741		~ 62,000 mi		
		Mk: PORSC Md: CARRE		

OLD
TO

SHIP
TO

PURCHASE ORD. NO.	SALES PERSON	MAIN PHONE	OTHER PHONE	SHIP VIA
	JM3			

Work Order

ITEM NO.	DESCRIPTION	QTY. ORDERED	QTY. SHIPPED	F.E.T.	PRICE	NET EXTENSION
1	TR/ 225/50-16 PIRELLI P7'S *****TIRE SERVICE PACKAGE***** *DISMOUNT/MOUNT TIRES-NO CHARGE *RUBBER VALVE STEMS-NO CHARGE *HIGH SPEED SPIN BALANCE-N/C * * *PLEASE CALL TWO DAYS AHEAD *ROTATIONS EVERY 5000 MILES *CHECK YOUR PRESSURE COLD * ONCE A MONTH * * FRONT <u>32</u> REAR <u>40</u> * *FLATS REPAIRED FREE-CALL AHEAD * *PLUG-TYPE REPAIRS OR USE OF TIRE *SEALER VOIDS ALL WARRANTIES, *INCLUDING FREE TIRE REPAIRS VALLEY TIRE & BRAKE -----LOANER N/C----- VALLEY TIRE HAS ROAD HAZARD COVERAGE AVAILABLE	2	2	0.00	179.80	359.60

SH

SubTot Parts:	359.60
Tax 7.500% :	26.97
Inv Total :	386.57

WARRANTY ON PARTS AND LABOR ARE 90 DAYS OR 3,000 MILES UNLESS OTHERWISE NOTED ON INVOICE. INSTALLED PARTS ARE NOT WARRANTIED BEYOND THAT GIVEN BY MANUFACTURER. ALL WARRANTIED MS MUST BE RETURNED WITH INVOICE WITHIN WARRANTY PERIOD FOR EXCHANGE OR CREDIT. ANY WARRANTY, PARTS OR LABOR HONORED ONLY AT VALLEY TIRE & BRAKE, SANTA ROSA, CALIFORNIA.

REPAIR ORDER

deJung Motorsport
 459 Portal St.
 Cotati, CA 94931
 (707) 664-8002
 BAR #:A.C. 101025

R/O # : 4602
 Name :
 Lic. # : 1PCY741
 Make : PORSCHE
 Model : CARRERA
 Year : 86
 Mileage : 61326
 Date : 06/03/94
 Save Parts : NO
 Needed By : 5 P.M. TODAY
 P.O. Number:

, CA

LABOR	Mech.	Amount
Major service:		
Tune up.		
Adjust valves.		
Full service.	SHOP	330.00
Hydraulic system flush.	SHOP	27.50

PARTS		Price	Qty.	Amount
PK 03	V/C GASKET KIT	29.90	1	29.90
10	**ENGINE OIL(PTS.)	1.00	22	22.00
KL 21	FUEL FILTER	27.80	1	27.80
OC 54	OIL FILTER	9.28	1	9.28
LX 77	AIR FILTER	13.15	1	13.15
03202	DISTRIBUTOR CAP	49.85	1	49.85
04163	ROTOR	15.05	1	15.05
B7EV	SPARK PLUG	6.25	6	37.50
01	TECHRON	6.95	1	6.95
03	WASHER SOLVENT	2.00	1	2.00
05	BRAKE FLUID	0.20	24	4.80
GL5	GEAR OIL (1/2 PINT)	0.90	12	10.80
FV182	PCV VALVE	4.40	1	4.40
5391016	CLAMP	0.92	1	0.92
5391220	CLAMP	1.00	1	1.00

RECOMMENDATIONS AND TECHNICIANS NOTES

911 659 053 01 control unit \$182.45.
 965 624 151 00 fan at engine \$276.05.

Original Estimate : 610.56

Total Labor	357.50
Total Parts	235.40
Total Sublets	0.00
	0.00
Sub Total	592.90
Tax	17.66
Total Amount \$	610.56

DATE	Increases to Estimate			NEW TOTAL
	TIME	Ok'd By	Emp.	

Parts & labor conditionally guaranteed 4,000 mi./ 90 days.

I hereby authorize deJung Motorsport to perform the above repair work along with necessary materials. You and your employees may operate the above vehicle for purposes of testing, inspection, or delivery at my risk. An express mechanics lien is acknowledged on above vehicle to secure the amount of repairs. Thereto it is understood that this company assumes no responsibility for loss or damage by theft or fire to vehicles placed with them for storage, sale, repair, or while road testing.

Authorized by: _____ Date _____

REPAIR ORDER

deJung Motorsport
 459 Portal St.
 Cotati, CA 94931
 (707) 664-8002
 BAR #:A.C. 101025

R/O # :4522
 Name :
 Lic. # :1PCY741
 Make :PORSCHE
 Model :CARRERA
 Year :86
 Mileage :59647
 Date :04/19/94
 Save Parts :NO
 Needed By :5 P.M. TODAY
 P.O. Number:

I
 . CA

LABOR	Mech. ID	Amount
Adjust brake pedal.		
Check out non op fog lights. Trace problem to the fog light relay. R&R relay.		
Check out non op fans in kick panels. Trace problem to the control unit.	SD	96.25

PARTS	Price	Qty.	Amount
911 615 108 01 RELAY	18.70	1	18.70
911 631 137 00 PLUG	0.20	1	0.20

RECOMMENDATIONS AND TECHNICIANS NOTES
 911 659 053 01 control unit \$182.45.
 965 624 151 00 fan at engine \$276.05.

Original Estimate :116.57				Total Labor	96.25
Increases to Estimate				Total Parts	18.90
DATE	TIME	OK'd By	Emp.	Total Sublets	0.00
					0.00
				Sub Total	115.15
				Tax	1.42
				Total Amount \$	116.57

Parts & labor conditionally guaranteed 4,000 mi./ 90 days.

I hereby authorize deJung Motorsport to perform the above repair work along with necessary materials. You and your employees may operate the above vehicle for purposes of testing, inspection, or delivery at my risk. An express mechanics lien is acknowledged on above vehicle to secure the amount of repairs. Thereto it is understood that this company assumes no responsibility for loss or damage by theft or fire to vehicles placed with them for storage, sale, repair, or while road testing.

Authorized by: _____ Date _____

REPAIR ORDER

deJung Motorsport
 459 Portal St.
 Cotati, CA 94931
 (707) 664-8002
 BAR #:A.C. 101025

R/O # :4386
 Name :
 Lic. # :1PCY741
 Make :PORSCHE
 Model :CARRERA
 Year :86
 Mileage :56679
 Date :01/28/94
 Save Parts :NO
 Needed By :5 P.M. TODAY
 P.O. Number:

. CA

LABOR	Mech. ID	Amount
Wash, trim, blow down.	ED	55.00
Oil change.	ED	55.00
Reconnected wiring at rear for wiper lift lights. (check for correct polarity of rear fans, will need more wire, and power is getting to the fans.)	ED	113.75

PARTS	Price	Qty.	Amount
Rel. and 105 Oil	80.99		80.99
Oil	14.51		14.51
Oil	11.00	22	22.00
Washer	0.99	1	0.99
Oil	0.99	1	0.99
Oil	0.99	1	0.99
Oil	0.99	1	0.99
Oil	0.99	1	0.99

Original Estimate \$170.49	Total Labor	128.75
Revised Estimate	Total Parts	157.49
DATE TIME Done By Est. NEW TOTAL	Total Sublets	0.00
		0.00
	Sub Total	286.24
	Tax	10.21
	Total Amount \$	271.49

Parts & labor conditionally guaranteed 4,000 mi./ 90 days.

Liability assumed by deJung Motorsport to perform the above repair work along with necessary materials.

You and your employees may operate the above vehicle for purposes of testing, inspection, or delivery at my risk. An express
 warranty is given & acknowledged on above vehicle to ensure the amount of repairs. Therefore it is understood that this company assumes
 no responsibility for loss of use or damage by theft or fire to vehicles placed with them for storage, sale, repair, or while road testing.

Signature: _____ Date: _____

AutoWash
800 777-2221

REPAIR ORDER

deJung Motorsport
459 Portal St.
Cotati, CA 94931
(707) 664-8002
BAR #:A.C. 101025

R/O # :4187
Name :
Lic. # :1PCY741
Make :PORSCHE
Model :CARRERA
Year :86
Mileage :52982
Date :10/15/93
Save Parts :NO
Needed By :5 P.M. TODAY
P.O. Number:

CA

LABOR	Mech. ID	Amount
R&R right heat exchanger hose.	80	5.00
R&I sunroof panel, remount sunroof plastic slide.	80	70.00
R&I right door panel, straighten door release linkage.	80	50.00
Adjust front hood latch.	80	5.00
Check oil pressure light. Problem is with the wiring on the switch.		

PARTS	Price	Qty.	Amount
930 21) 331 09 HOSE	31.14	1	31.14

PAID
OK # 1948

Original Estimate	\$163.48	Total Labor	130.00	
Increases to Estimate		Total Parts	31.14	
DATE	TIME	OK'd By	Emp.	
			NEW TOTAL	
			Total Sublets	0.00
			Sub Total	161.14
			Tax	2.34
			Total Amount \$	163.48

Parts & labor conditionally guaranteed 4,000 mi./ 90 days.
I hereby authorize deJung Motorsport to perform the above repair work along with necessary materials.
You and your employees may operate the above vehicle for purposes of testing, inspection, or delivery at my risk. An express mechanics lien is acknowledged on above vehicle to secure the amount of repairs. Thereto it is understood that this company assumes no responsibility for loss or damage by theft or fire to vehicles placed with them for storage, sale, repair, or while road testing.

Authorized by: _____ Date _____

INVOICE NO. R49259

PAGE 1 OF 1

REPAIR ORDER ORIGINAL STATUS COMPL DATE 05/30/90

YEAR MAKE MODEL COLOR LICENSE VEHICLE NUMBER DELIVERED

CUST. NO.

144

MILEAGE TIME PROMISED ORG. EST. REV. EST.

SERV. ADV. Q.C.

BUSINESS PHONE

HOME PHONE

TAX IDENTIFICATION P.O. NUMBER SHIP VIA DATE & TIME INITIATED SOURCE

05/25/90 17:00 01

MAKE	SOURCE/REV	QUANTITY	PART/LABOR DESCRIPTION	UNIT PRICE	EXTENDED PRICE
0	01	1	LOCTITE 57	24.89	24.89
0	01	1	PRESSURE P	239.90	239.90
0	01	1	CLUTCH DIS	164.75	164.75
0	01	1	RELEASE BE	136.84	136.84
0	01	1	GASKET	15.74	15.74
0	01	1	OPTIMOL HI	10.51	10.51
0	01	1	SEAL RING	4.48	4.48
0	01	1	O RING	2.10	2.10
0	01	1	SURFACE DISC		
0	01	1	00004301000		
0	01	1	91511600122		
0	01	1	91511601122		
0	01	1	91511606280		
0	01	1	91590322500		
0	01	1	00004302400		
0	01	1	99711382740		
0	01	1	99970135940		
0	01	1	000046		



ECEIVED BY:		489 16795
COMMENT:		
SUBTOTAL	599.91	
FREIGHT	.00	
*HANDLING	.00	
TAX	.00	
TOTAL	599.91	

"ALL PARTS MARKED OR LISTED AS NPN, ARE NOT GENUINE PORSCHE PARTS OR ACCESSORIES AND ARE, THEREFORE, NOT COVERED BY A PORSCHE CARS NORTH AMERICA, INC. WARRANTY."

he Factory Warranty Constitutes All Of The Warranties With Respect To The Sale Of This Item/Items. The Seller Hereby Expressly Disclaims All Warranties, Either Express Implied, Including Any Implied Warranty Of Merchantability Or Fitness For A Particular Purpose, And The Seller Neither Assumes Nor Authorizes Any Other Person To Assume For It Any Liability In Connection With The Sale Of This Item/Items.

NOTICE:
ELECTRICAL PARTS NOT RETURNABLE. NO REFUNDS ON SPECIAL ORDER ITEMS.
20% HANDLING ON RETURNED MERCHANDISE.
NO REFUNDS AFTER 30 DAYS. THANK YOU.
PLEASE READ REVERSE SIDE

INVOICE NO

49259

INVOICE NO. RAVI

PAGE 1 OF 1

REPAIR ORDER ORIGINAL STATUS COMPL DATE 05/22/90

VEHICLE NUMBER

LICENSE

COLOR

YEAR MAKE MODEL

CUST. NO.

BUSINESS PHONE

HOME PHONE

MILEAGE

TIME PROMISED

ORG. EST.

REV. EST.

SERV. ADV. Q.C.

DELIVERED

SHIP VIA DATE & TIME INITIATED

P.O. NUMBER

TAX IDENTIFICATION

SOURCE

05/22/90 16134 01

MAKE	SOURCE#	QUANTITY	PART/LABOR DESCRIPTION	UNIT PRICE	EXTENDED PRICE
0	01	1	BATTERY	124.15	124.15

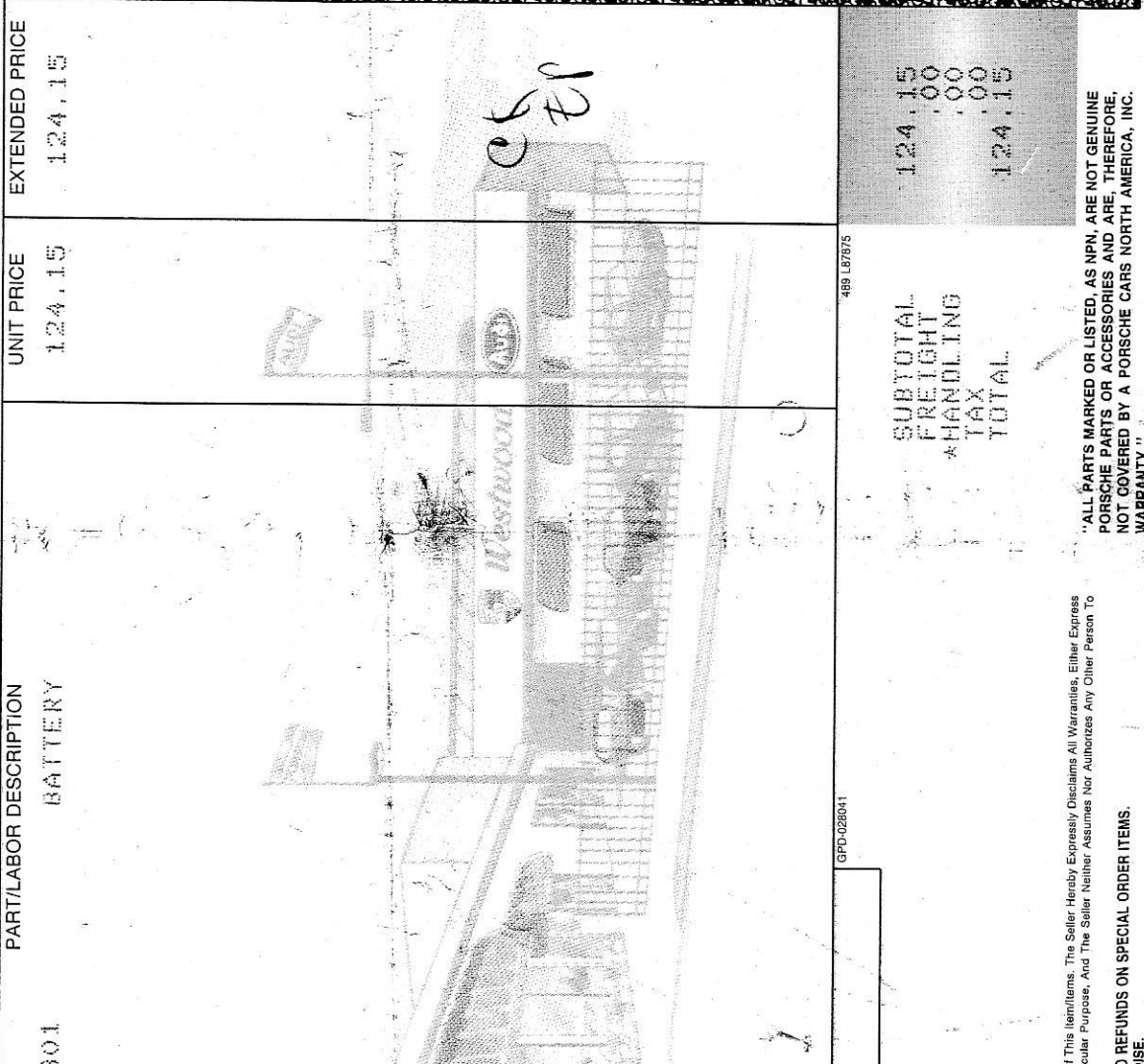

SUBTOTAL	124.15
FREIGHT	.00
*HANDLING TAX	.00
TOTAL	124.15

489 LB7915

GPD-028041

RECEIVED BY:

COMMENT:

The Factory Warranty Constitutes All Of The Warranties With Respect To The Sale Of This Item/Items. The Seller Herby Expressly Disclaims All Warranties, Either Express Or Implied, Including Any Implied Warranty Of Merchantability Or Fitness For A Particular Purpose, And The Seller Neither Assumes Nor Authorizes Any Other Person To Assume For It Any Liability In Connection With The Sale Of This Item/Items.

NOTICE: ELECTRICAL PARTS NOT RETURNABLE. NO REFUNDS ON SPECIAL ORDER ITEMS.
 *20% HANDLING ON RETURNED MERCHANDISE.
 NO REFUNDS AFTER 30 DAYS. THANK YOU.
 PI FASE REAN BEVEGE CINE

"ALL PARTS MARKED OR LISTED, AS NPN, ARE NOT GENUINE PORSCHE PARTS OR ACCESSORIES AND ARE, THEREFORE, NOT COVERED BY A PORSCHE CARS NORTH AMERICA, INC. WARRANTY."

INVOICE NO

50900

WARRANTY

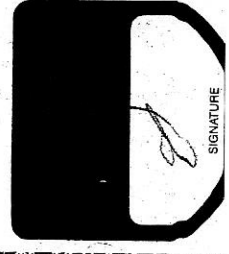

+9172

NO. REF. NO.	49259 32645	EL MI. SP. PT. WTY.	52290	REPAIR DATE	5/22/86	VEHICLE IDENTIFICATION NO.	WPA0A091665120538	LICENSE NO.	1PCV74186	YEAR	1986	MAKE	Porsche	MODEL	911
NAME		ADDRESS		CITY, ST.		DELIVERY DATE SP. PT.		SERVICE ADVISOR		RES. PHONE		AUTHORIZED REPRESENTATIVE		BUS. PHONE	
M.A.		11111		B.H. CA		5/22/86		Robert		231-2300		[Signature]		231-2300	
WARRANTY DAMAGE CODE		ID		CLAIM TYPE		MECH. NO.		COMPLAINT		DESCRIPTION		AMOUNT			
A		A		2		34351903		OIL LEAK		Oil Leak		A			
B		B		3445195A		34351903		Trans Gasket Leaking		Trans Gasket Leaking		A			
C		C						Replace Engine + Trans		Replace Trans Gasket		A			

SUBLET REPAIRS		QTY.	PART NO.	DESCRIPTION	PRICE
TOTAL SUBLET		↑			
PARTS #					
INVOICE #					
NUMBERS #					
TOTAL PARTS		↑			
QTS. OIL @					
GREASE & OIL @					
THE FOLLOWING PARTS HAD TO BE ORDERED:					

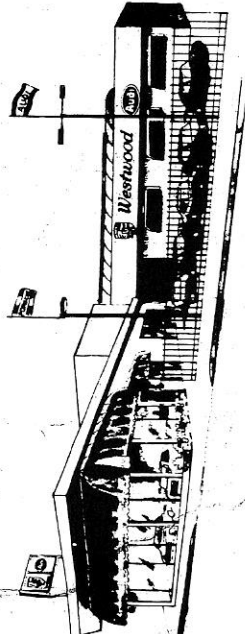

10959 SANTA MONICA BLVD. • LOS ANGELES, CA 90025
 PHONE (213) 478-4095

PLEASE CHECK BACK ON DATE:
 CUSTOMER DOES NOT CHECK BACK FOR ABOVE PARTS TO BE INSTALLED ON THE DATE ABOVE, WE CANNOT REPAIR THE CAR ON WARRANTY UNLESS THE FACTORY SAYS SO.



MECH. # 7

REF. R.O. # 21561

DATE 07/31/87

NEW CUST. REG. CUST.

CUSTOMER NAME: LA CA. 90021

ADDRESS: LA CA. 90021

CITY: LA CA. STATE: ZIP:

TELEPHONE: BUSINESS PHONE:

ELAPSED MILEAGE SPARE PT. WTY. SERVICE ADVISOR

REPAIR DATE MODEL TIME RECEIVED TIME PROMISED

DELIVERY DATE LICENSE NO. SELLING DEALER

WARRANTY

No. W 21561

MILEAGE 14285

YEAR 86

MODEL NO. 1911340

14285

11:00

121785

1247761

0257

B.A.R. #AD-101802

NOTICE TO CONSUMER, PLEASE READ IMPORTANT INFORMATION ON BACK.

SUBJECT TO THE CONDITIONS ON THE REVERSE SIDE.

ALL PARTS ARE NEW UNLESS SPECIFIED WITH AN 'X'

QTY.	P/NUMBER/	DESCRIPTION	PRICE	L/OPERATION/	# TIME UNITS
1	1606800	SPRINK	50.29	3033AD	.70
1	0000100	FLOOR	4.00		
TOTAL PARTS					
SUBLET REPAIRS					
TOTAL					

Clutch removed on 7/29/87
car is glib - pedal in leg
clutch mechanism down
sept check out spring broken

A/C not blowing cold
evaporator system also has leaks
LEAKY FITTING AT RECEIVER
DRYER TIGHT.

P.O. NO.

SUBLET REPAIRS

AMOUNT

L \$ SUBLET

E/EXPLAIN/

P \$ SUBLET

TC TOWING

LY LOANER

W/DAMAGE CODE

REF WTY CODE

W/DAMAGE CODE

REF



PORSCHE GLENDALE AUDI

1620 SOUTH BRAND BLVD.
GLENDALE, CA 91204

(818) 502-1551 • 241-4111

B.A.R. LICENSE #AD-101802

B.A.R. LICENSE # AD101802

MECH. #

COLOR *Blue* REF. R.O. #

No. 66399

DATE

07/31/87

I, the Registered Owner authorize you to perform the below repairs and furnish necessary parts. I understand any cost quoted heretofore is an estimate only. Your employees may operate vehicle for inspection, testing, delivery at my risk. You will not be responsible for loss or damage to vehicle or articles left in it. I agree to pay reasonable storage on vehicle left more than 48 hrs. after completion of repairs are completed. I AGREE THAT YOU HAVE AN EXPRESS LIEN ON THE ABOVE DESCRIBED VEHICLE FOR THE CHARGES FOR PARTS AND LABOR FURNISHED UNDER THIS REPAIR ORDER INCLUDING THOSE FROM ANY PRIOR REPAIR ORDER ON THIS VEHICLE. I AGREE TO FAIL TO PAY SUCH CHARGES. I AGREE THAT THE VEHICLE MAY BE SOLD, AFTER 20 DAYS NOTICE, IN THE MANNER PROVIDED FOR IN SECTIONS 3071 TO 3075 OF THE CALIFORNIA VEHICLE CODE. In the event an attorney is retained to foreclose this lien or to bring suit for collection, my sums due I agree in pay costs of collection and reasonable attorney fees.

PLEASE READ IMPORTANT INFORMATION ON BACK.

PRELIMINARY ESTIMATE

\$

\$

\$

\$

\$

\$

\$

\$

\$

\$

\$

\$

\$

\$

\$

\$

\$

\$

\$

\$

\$

\$

\$

\$

\$

\$

\$

\$

\$

\$

\$

\$

\$

\$

\$

\$

\$

\$

\$

\$

\$

\$

\$

\$

\$

\$

\$

\$

\$

\$

\$

\$

\$

\$

\$

\$

\$

\$

\$

\$

\$

\$

\$

\$

\$

\$

\$

\$

\$

\$

\$

\$

\$

\$

\$

\$

\$

\$

\$

"I ACKNOWLEDGE NOTICE AND ORAL APPROVAL OF AN INCREASE IN THE ORIGINAL ESTIMATED PRICE"

X

SIGNATURE

P / NUMBER /

DESCRIPTION

PRICE

QTY

AMOUNT

COMPRESSION TEST: 1. 2. 3. 4. 5. 6. 7. 8.

L/OPERATION/ # TIME UNITS

COMPLAINT

CAUSE

CORRECTION

COMPLAINT

CAUSE

CORRECTION

COMPLAINT

CAUSE

CORRECTION

COMPLAINT

CAUSE

CORRECTION

COMPLAINT

CAUSE

CORRECTION

COMPLAINT

CAUSE

CORRECTION

COMPLAINT

CAUSE

CORRECTION

COMPLAINT

CAUSE

CORRECTION

COMPLAINT

CAUSE

CORRECTION

COMPLAINT

CAUSE

CORRECTION

COMPLAINT

CAUSE

CORRECTION

COMPLAINT

CAUSE

CORRECTION

COMPLAINT

CAUSE

CORRECTION

REG. CUST. NEW CUST.

CUSTOMER NAME: *HA Ca. 90001*

ADDRESS: *HA Ca. 90001*

CITY: *HA Ca. 90001* STATE: *CA* ZIP: *90001*

TELEPHONE: *90001* BUSINESS PHONE: *90001*

REPAIR DATE: *11/00* MODEL: *1PC4761*

ELAPSED MILEAGE SPARE PT. WTY. *19285* SERVICE ADVISOR: *7771*

MILEAGE: *19285* YEAR: *86* MODEL NO. *1911300*

WPOAB09106S130538

QTY	P / NUMBER /	DESCRIPTION	AMOUNT
		Clutch popped on 175 gear	
		Refer to #91561	
		bad recent in thru	
		micro ck belt connection	

DESCRIPTION	KEY	ACCT NO.	SALE
MECH LABOR - A	C	4411	
MECH LABOR - P	C	4407	
PARTS - A	C	4701	
ACCESS - A	C	4711	
PTS. & ACC.	C	4721	
GAS OIL GREASE	C	4457	
SUBLET REPAIR	C	4491	
SHOP SUPPLIES	C	6442	
CUSTOMER NUMBER		2221	
TAX		1304	
CHARGE SALES		1188	
CASH SALES		1804	
EMPLOYEE CHARGES			

GLENDALE PORSCHE

GLENDALE AUDI

Audi

1620 SOUTH BRAND BLVD.
GLENDALE, CA 91204
(818) 502-1551 • 241-4111

ADDITIONAL WORK NEEDED:

1. _____

2. _____

3. _____

4. _____

5. _____

*SUPPLIES - A labor charge equivalent to 5% of the labor charge is included for supplies used on your vehicle. Maximum charge is \$10.00. Applicable supply items are: Nuts, bolts, washers, tape, pins, aerospray, shellac, solvent, rags, carburetor cleaner, towels, solder, battery cleaner, wiper/window sealant, etc.

TIME CALLED	1	2	3	4
1				
2				
3				
4				
5				
6				
7				
8				
9				
10				
11				
12				
13				
14				
15				
16				
17				
18				
19				
20				
21				
22				
23				
24				
25				
26				
27				
28				
29				
30				
31				
32				
33				
34				
35				
36				
37				
38				
39				
40				
41				
42				
43				
44				
45				
46				
47				
48				
49				
50				
51				
52				
53				
54				
55				
56				
57				
58				
59				
60				
61				
62				
63				
64				
65				
66				
67				
68				
69				
70				
71				
72				
73				
74				
75				
76				
77				
78				
79				
80				
81				
82				
83				
84				
85				
86				
87				
88				
89				
90				
91				
92				
93				
94				
95				
96				
97				
98				
99				
100				

NO. CP. 5551

TIME REC. 1/22 DISPATCH NO. 143

MECHANIC NO. 74

CHASSIS NO. 100119091

Z NO SERVICE FOLLOW-UP DATE 06/18/87

51487CP. 5551

DISCARD REMOVED PARTS YES NO

NAME: L.A. CITY: L.A. CA. 90007

TIME PROMISED: 2nd R.Q. No. I hereby authorize the shop work to be done along with the necessary material, and hereby grant you or your employees the vehicle herein described on streets, highways or elsewhere for the purpose of testing and/or inspection. Subject to conditions of reverse side of this contract.

REPAIR DATE: 06/18/87 MODEL: 85

QTY	PART NUMBER	DESCRIPTION	PRICE
1	1911	Washer	53.00
1	939077	Oil Pan	13.95
1	930110	Pin	15.95
1	220110	Pin	25.75
1	220110	Pin	12.50
1	911135	Front Pad	139.00
1	911135	Rear Pad	139.00
1	224606	Shims	44.50
1	224606	Shims	20.00
1	017738	Bulb	44.50
1	017738	Bulb	45.50

ZIPPER PORSCHE
SALES • SERVICE • PARTS
8423 Wilshire Boulevard
Beverly Hills California 90211
telephone 213-655-5414

WE RECOMMEND THE FOLLOWING REPAIRS:

1. _____
2. _____
3. _____

DISCARD REMOVED PARTS YES NO

QTS. OIL _____
LBS. TRANS. GREASE _____
BRAKE FLUID _____
AUTOMATIC TRANS. FLUID _____
TOTAL GAS - OIL & GREASE _____

TOTAL SUBLET REPAIRS _____

CUSTOMER INITIAL: _____ SUBLET REPAIRS: _____

MECH LABOR 4400
OIL & GREASE 4451
SUBLET 4491
PARTS 470L
ACCESS. 4711
*SUPPLIES 4421

TAX 2221
SUB TOTAL 1304
CHARGE 1188
CASH

COMPRESSION TEST: 1 2 3 4 5 6 7 8

PERIOD: MAY 07 1987

PER: _____

ALL PARTS, ACCESSORIES AND LABOR ARE WARRANTED FOR 6000 MILES OR 6 MONTHS. THIS WARRANTY IS IN LIEU OF ALL OTHER EXPRESS OR IMPLIED WARRANTIES.

I.O. NO. CP- 5551

PRIOR BODY DAMAGE
LF RF LR RR

TIME REC 1/22 DISPATCH NO. 1473 MECHANIC NO. 5011

2nd R.O. No. CHASSIS NO. 1A019091 TIME PROMISED 1/22/88

Z (NO SERVICE FOLLOW-UP) DATE 1/20/88

5/4/87 CP. 5551

DISCARD REMOVED PARTS YES NO

NAME _____

ADDRESS _____

CITY _____ ZIP _____

I hereby authorize the repair work to be done along with the necessary material, and hereby grant your employees permission to operate the vehicle on public streets, highways or elsewhere for the purpose of testing and/or inspection. Subject to conditions on reverse side of this contract.

PLEASE READ REVERSE SIDE FOR LIMITED WARRANTY AND TERMS.

SIGN _____

CUSTOMER ACKNOWLEDGES RECEIPT OF A COPY HEREOF

ORIGINAL ESTIMATE # _____

DATE _____ TIME _____ PERSON CONTACTED _____

CONTACTED VIA _____ PHONE _____ IN PERSON

TELEPHONE-RES. _____ CHARGE OK'D BY _____

TELEPHONE NO. _____ EXT. _____

REPAIR DATE _____ MILEAGE _____

DEL. DATE _____ MODEL YR _____

SELLING DEALER _____

PARTS SUBMIT _____

Y = YES X = NO

SERV. ADV. LICENSE NO. _____

I ACKNOWLEDGE NOTICE AND ORAL APPROVAL OF AN INCREASE IN THE ORIGINAL ESTIMATED PRICE.

CUST. INTL. X _____

TERMS: STRICTLY CASH

FOR YOUR CONVENIENCE WE ACCEPT THE FOLLOWING CREDIT CARDS:

VISA • MASTERCARD

— 0 —

SERVICE AND PARTS DEPT. HOURS:

MONDAY THRU FRIDAY
7:30 A.M. to 6:00 P.M.

VEHICLES MUST BE PICKED UP DURING SERVICE DEPARTMENT HOURS.

— 0 —

ALL PARTS INSTALLED ARE NEW UNLESS SPECIFIED OTHERWISE.

ALL PARTS REMOVED FROM YOUR VEHICLE WILL BE DISCARDED UNLESS OTHERWISE INSTRUCTED.

— 0 —

Thank you for this opportunity to serve you. It is our aim to perform all repairs to your complete satisfaction. If you are not completely satisfied, please contact us immediately.

THANK YOU

1	2	3	4	5	6	7	8	
1								
2								
3								
4								
5								
6								
7								
8								
9								
10								
11								
12								
13								
COMPRESSION TEST								

PORSCHE

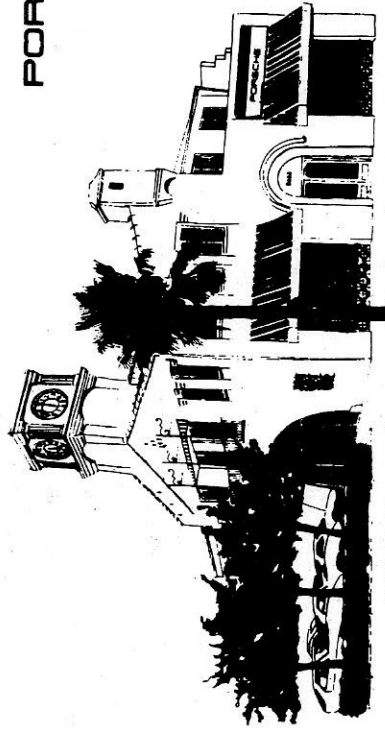

ZIPPER PORSCHE
8423 Wilshire Boulevard, Beverly Hills, California 90211
Phone 213-655-5414

ALL PARTS, ACCESSORIES AND LABOR ARE WARRANTED FOR 6000 MILES OR 6 MONTHS. THIS WARRANTY IS IN LIEU OF ALL OTHER EXPRESS OR IMPLIED WARRANTIES.