

# 1988 Chevrolet Suburban



1GNGR26N3JF131139



## Vehicle History Report™

### 1988 CHEVROLET SUBURBAN R20

VIN: 1GN GR26N3JF131139  
 4 DOOR WAGON/SPORT UTILITY  
 7.4L V8 F OHV GASOLINE  
 REAR WHEEL DRIVE



No accidents or damage reported to CARFAX



15 Service history records



35 Detailed records available

This CARFAX Vehicle History Report is based only on information supplied to CARFAX and available as of 5/10/24 at 6:00:32 PM (CDT). Other information about this vehicle, including problems, may not have been reported to CARFAX. Use this report as one important tool, along with a vehicle inspection and test drive, to make a better decision about your next used car.



### Additional History

Not all accidents / issues are reported to CARFAX

#### Summary

#### Total Loss

No total loss reported to CARFAX.



No Issues Reported

#### Structural Damage

No structural damage reported to CARFAX.



No Issues Reported

#### Airbag Deployment

No airbag deployment reported to CARFAX.



No Issues Reported

#### Odometer Check

Inconsistent mileage indicated.

Mileage Inconsistency

#### Accident / Damage

No accidents or damage reported to CARFAX.



No Issues Reported

#### Manufacturer Recall

No open recalls reported to CARFAX. Check for open recalls on GM vehicles at recalls.gm.com.



No Recalls Reported

#### Basic Warranty

No data reported to CARFAX.

No Data Reported



### Title History

#### Summary

#### Damage Brands

Salvage | Junk | Rebuilt | Fire | Flood | Hail | Lemon





No Problem







**Odometer Brands**









Not Actual Mileage | Exceeds Mechanical Limits



No Problem

**CARFAX Detailed History**

Date	Mileage	Source	Comments
04/12/1993	50,087	California Inspection Station Santa Rosa, CA	<b>Passed emissions inspection</b>
02/21/1995	71,313	California Inspection Station Santa Rosa, CA	<b>Passed emissions inspection</b>
02/10/1997	88,837	California Inspection Station Santa Rosa, CA	<b>Passed emissions inspection</b>
10/16/1998	3,894	Shiloh Auto Repair Santa Rosa, CA 707-523-4242	 <b>Vehicle serviced</b> Maintenance inspection completed POTENTIAL ODOMETER ROLLOVER
			<div style="border: 1px solid gray; padding: 5px;">                         FYI, this vehicle has a 5-digit odometer so it probably reset to zero when mileage exceeded 99,999. Any reported mileage since then is potentially unreliable.                     </div>
11/02/1998	4,169	Shiloh Auto Repair Santa Rosa, CA 707-523-4242	 <b>Vehicle serviced</b> Maintenance inspection completed Steering gear replaced Radiator hose clamp replaced Power steering checked
03/30/1999	106,704	Service Facility Santa Rosa, CA	 <b>Vehicle serviced</b>
03/30/1999		California Inspection Station Santa Rosa, CA	<b>Passed emissions inspection</b>
03/31/1999		Shiloh Auto Repair Santa Rosa, CA 707-523-4242	 <b>Vehicle serviced</b> Maintenance inspection completed Oil and filter changed Cooling system checked Fluids checked Light bulb(s) replaced Emissions inspection performed

11/03/1999	109,798	Shiloh Auto Repair Santa Rosa, CA 707-523-4242		<b>Vehicle serviced</b> Radiator replaced Oil and filter changed Antifreeze/coolant checked
02/27/2000		California Motor Vehicle Dept. Santa Rosa, CA		<b>Title issued or updated</b>
04/05/2001	120,953	California Inspection Station Santa Rosa, CA		<b>Failed emissions inspection</b>
04/05/2001		Service Facility Santa Rosa, CA		<b>Vehicle serviced</b>
04/05/2001		California Inspection Station Santa Rosa, CA		<b>Passed emissions inspection</b>
03/17/2003	31,722	Service Facility Santa Rosa, CA		<b>Vehicle serviced</b>  <b>MILEAGE INCONSISTENCY</b>  The mileage reported here conflicts with this vehicle's odometer history. Ask a mechanic or the seller to confirm the actual mileage - this entry may just be a clerical error.
				
03/17/2003		California Inspection Station Santa Rosa, CA		<b>Passed emissions inspection</b>
03/02/2005	39,006	California Inspection Station		<b>Passed emissions inspection</b>
06/29/2005	39,502	Midas Santa Rosa, CA 707-527-9310  ★ 4.1 / 5.0 8 Verified Reviews ♥ 13 Customer Favorites		<b>Vehicle serviced</b> Exhaust system checked
03/15/2007	42,386	California Inspection Station		<b>Passed emissions inspection</b>
10/01/2007	43,890	Sears Auto Center Santa Rosa, CA 707-571-5628  ★ 4.4 / 5.0 29 Verified Reviews		<b>Vehicle serviced</b>

01/25/2008	44,134	Santa Rosa Chevrolet Isuzu Santa Rosa, CA 707-544-1414		<b>Vehicle serviced</b> Maintenance inspection completed
05/14/2009	44,862	California Inspection Station Santa Rosa, CA		<b>Passed emissions inspection</b>
09/09/2010		California Motor Vehicle Dept. Chandler, AZ		<b>Registration updated when owner moved the vehicle to a new location</b>
06/02/2011	45,863	California Inspection Station Santa Rosa, CA		<b>Failed emissions inspection</b>
06/02/2011	45,872	California Inspection Station Santa Rosa, CA		<b>Passed emissions inspection</b>
04/30/2013	46,308	California Inspection Station Santa Rosa, CA		<b>Passed emissions inspection</b>
05/06/2015	46,683	Norcal Car Care Santa Rosa, CA 707-568-5080		<b>Vehicle serviced</b> Tire condition and pressure checked Emissions inspection performed
05/06/2015		California Inspection Station Santa Rosa, CA		<b>Passed emissions inspection</b>
04/24/2017	48,139	California Inspection Station Santa Rosa, CA		<b>Passed emissions inspection</b>
07/06/2017		Larsen Auto Care Santa Rosa, CA 707-535-0720  <b>5.0 / 5.0</b> 26 Verified Reviews  <b>24 Customer Favorites</b>		<b>Vehicle serviced</b>
09/01/2017	48,798	Larsen Auto Care Santa Rosa, CA 707-535-0720  <b>5.0 / 5.0</b> 26 Verified Reviews  <b>24 Customer Favorites</b>		<b>Vehicle serviced</b> Rear shock absorber(s) replaced

03/05/2019	50,018	California Inspection Station Santa Rosa, CA		<b>Passed emissions inspection</b>
08/01/2019	50,389	Larsen Auto Care Santa Rosa, CA 707-535-0720 ★ 5.0 / 5.0 26 Verified Reviews ♥ 24 Customer Favorites		<b>Vehicle serviced</b> Air filter replaced Oil and filter changed
05/10/2021	50,895	California Inspection Station Santa Rosa, CA		<b>Passed emissions inspection</b>
02/10/2023		Larsen Auto Care Santa Rosa, CA 707-535-0720 ★ 5.0 / 5.0 26 Verified Reviews ♥ 24 Customer Favorites		<b>Vehicle serviced</b> Oil pressure sender/switch replaced Oil and filter changed
05/02/2023	51,479	California Inspection Station Santa Rosa, CA		<b>Passed emissions inspection</b>

Have Questions? Please visit our Help Center at [www.carfax.com](http://www.carfax.com).



### Glossary

**Failed Emissions Inspection**

The emissions check performed during a vehicle inspection indicated the vehicle was emitting more than allowable emissions standards and/or had missing or modified parts. Repeated failed emissions records can indicate engine problems and CARFAX recommends you have the vehicle inspected.

**Mileage Inconsistency**

If an odometer reading is less than a previous reading but CARFAX is uncertain whether the discrepancy is a rollback or a clerical error, then CARFAX calls it a "Mileage Inconsistency". In this case, you should verify the mileage with your dealer or a qualified mechanic.

**Odometer Rollover**

Older vehicles often have 5-digit odometers that roll over to zero when the mileage exceeds 99,999.

**Title Issued**

A state issues a title to provide a vehicle owner with proof of ownership. Each title has a unique number. Each title or registration record on a CARFAX report does not necessarily indicate a change in ownership. In Canada, a registration and bill of sale are used as proof of ownership.

Follow Us:  [facebook.com/CARFAX](https://facebook.com/CARFAX)  [@CARFAXinc](https://twitter.com/CARFAXinc)  [About CARFAX](#)

CARFAX DEPENDS ON ITS SOURCES FOR THE ACCURACY AND RELIABILITY OF ITS INFORMATION. THEREFORE, NO RESPONSIBILITY IS ASSUMED BY CARFAX OR ITS AGENTS FOR ERRORS OR OMISSIONS IN THIS REPORT. CARFAX FURTHER EXPRESSLY DISCLAIMS ALL WARRANTIES, EXPRESS OR IMPLIED, INCLUDING ANY IMPLIED WARRANTIES OF MERCHANTABILITY OR FITNESS FOR A PARTICULAR PURPOSE.

© 2024 CARFAX, Inc., part of S&P Global. All rights reserved.  
5/10/24 6:00:32 PM (CDT)

**Larsens Auto CARE**

940 PETALUMA HILL RD  
 SANTA ROSA, CA. 95404  
 (707) 535-0720 Fax: (707) 535-0721  
 Writer: MATT HERNANDEZ



**INVOICE #1033689**

larsenauto@gmail.com  
 https://larsenautocare.com/  
 BAR# ARD00283685  
 EPA# CAL000367517

CUSTOMER: 39... /E SANTA ROSA, CA. 95409  
 Cell: (707) ...  
 YEAR: 1988  
 MAKE/MODEL: CHEVROLET SUBURBAN R20  
 VIN #: 1GNCR26N3JF131139  
 ENGINE: V8-454 7.4L OHV  
 TRANS: AUTOMATIC/RWD  
 LICENSE #/PROD: 2JHY101/  
 MILES IN/MILES: 151441/

In: 2/8/2023 Out: 2/10/2023 Email: BJVANNOY99@GMAIL.COM

<b>VEHICLE ISSUE #1: DIAGNOSE(OIL PRESSURE) GAUGE IS SAYING ZERO AT IDLE</b>			
TECH REPORT: CHECK FOR 0PSI READING ON OIL PRESSURE GAUGE. WHEN HOT GAUGE READS 0PSI. RECOMMEND REPLACING OIL SENDING UNIT. REPLACE OIL SENDER AND RECHECK, GAUGE NOW READS BETWEEN 45 & 65PSI. WORKING AS DESIGNED INTENT.			
ADV NOTES: MATT HERNANDEZ: ORAL AUTHORIZATION FROM BETTY VAN NOY 707-953-2389 2/8/23 3:47PM TO REPLACE OIL PRESSURE SENDER.			
PART: 1802-36801	OIL PRESSURE SENDER	1 @ \$64.99	\$64.99 NEW
LABOR:	DIAGNOSE OIL PRESSURE		\$175.00 LABOR
LABOR:	REPLACE OIL PRESSURE SENDER		\$157.50 LABOR
Total for "DIAGNOSE(OIL PRESSURE) GAUGE IS SAYING ZERO AT IDLE": \$397.49			
<b>VEHICLE ISSUE #2: RECOMMENDATIONS: 4 TIRES 235/85R16 &amp; ALIGNMENT \$1050.00, A/C DIAGNOSE (INOP) \$175.00 (CUSTOMER DECLINED)</b>			
*** CUSTOMER DECLINED THIS REPAIR AT THIS TIME ***			
Total for "RECOMMENDATIONS: 4 TIRES 235/85R16 & ALIGNMENT \$1050.00, A/C DIAGNOSE (INOP) \$175.00": \$0.00			
<b>VEHICLE ISSUE #3: TIRE PRESSURE</b>			
LABOR:	FRONTS: <u>50</u> REARS: <u>60</u>		\$0.00 LABOR
Total for "TIRE PRESSURE ": \$0.00			
Payment Rec'd	Visa	Date: 2/10/2023	\$403.50

Recommended Repairs: *** CUSTOMER DECLINED: RECOMMENDATIONS: 4 TIRES 235/85R16 & ALIGNMENT \$1050.00, A/C DIAGNOSE (INOP) \$175.00 ( \$0.00)	Labor/Jobs	\$332.50
	Parts	\$64.99
Warranty: From the date of delivery for a period of [24 months] months or [24k] miles, whichever comes first, this firm will repair free of charge any defects in material and workmanship to the repairs stated on the invoice. All work to be done in our shop only. This does not include towing charges or customer supplied parts. A storage fee of [\$150.00] per day will be charged 24 hours after notification that work is complete. Neglect/abuse of vehicle will immediately void any and all warranties. The above estimate for recommendations on parts & labor are subject to change due to parts prices and labor prices. Thank you.	Sublet	\$0.00
	Total Fees	\$0.00
	Subtotal	\$397.49
	Tax @ 9.25%	\$6.01
	Total	\$403.50
	Payments	\$403.50
	Balance	\$0.00

Replaced parts may be requested by customer. I hereby authorize the above repair work to be done along with all necessary materials. You and your employees may operate the above vehicle for the purposes of testing, inspection or delivery at my risk. An express mechanic's lien is acknowledged on the above vehicle to secure the amount of repairs thereto. The shop will not be held responsible for loss or damage to vehicle or articles left in vehicle in case of fire, theft, accident or any other cause beyond your control. In the event legal action is necessary to enforce this contract, I understand that I am solely responsible for all costs including attorney's fees and court costs. I have read the above and acknowledge receipt of an estimate.



# EMISSION CONTROL WORK ORDER



## THE SMOG CENTER, INC.

968 B Piner Road  
 SANTA ROSA, CA 95403  
 (707) 546-SMOG (7664)  
 BAR# ARD231510

www.smogcentersantarosa.com



U98704

Date: 5-1-23  
 Time Received  
 A.M. P.M.  
 Promised A.M. P.M.  
 Written By

<b>BILLING</b>	<input type="checkbox"/> CASH	Name			<b>PHONE</b>	Phone when ready Yes <input type="checkbox"/> No <input type="checkbox"/>	
	<input type="checkbox"/> BANK CARD NO.	Address	17A AVE			Bus.	
	<input type="checkbox"/> OIL CO. CARD NO.	City	Santa Rosa			Inspector	
	<input type="checkbox"/> CHECK NO.	Year - Model	1988 Chevy	Odometer		51479	Mech.
	<input type="checkbox"/> OTHER	Vin No.	1132 86211924	License No.		2J41Y101	

ALL PARTS ARE NEW UNLESS OTHERWISE DESIGNATED

**REPAIR ORDER LABOR INSTRUCTION**

INTERNAL  
 36.75  
 8.25

QTY. *	PART NO. OR DESCRIPTION	PRICE	AMOUNT
	NOTE:		
	NO EVAP Test Performed <input type="checkbox"/>		
	EVAP System Not Accessible <input type="checkbox"/>		
	AIR	A/C	
	Fuel	EP	
	OIL	MC	
	DC	PC	
	<b>TOTAL PARTS</b>		4.00

I/M SMOG INSPECTION  
 I/M SMOG CERTIFICATE  
 EVAP TEST (1978 - 1995 Vehicles Only)  
 Fed/Cal Auto/Man B/Change of Owner Eng Size 7.4

We are a TEST ONLY facility & can NOT perform any repairs or adjustments to your vehicle if it fails.  
 Smog Inspection Fee is Due Whether Your Vehicle Passes, Fails, Or The Test is Aborted.

THIS IS TO ADVISE YOU THAT SOME EMISSION CONTROL DEVICES MAY STILL BE COVERED UNDER MFG.'S WARRANTY.  
 BY LAW, YOU MAY CHOOSE ANOTHER LICENSED SMOG CHECK FACILITY TO PERFORM ANY NEEDED REPAIRS OR ADJUSTMENTS THAT THE SMOG CHECK TEST INDICATES ARE NECESSARY.

I hereby authorize the above repair work to be done along with the necessary material, and hereby grant you and/or your employees, permission to operate the car, truck or vehicle herein described on streets, highways or elsewhere for the purpose of testing and/or inspection. An express mechanic's lien is hereby acknowledged on above car, truck or vehicle to secure the amount of repairs thereto. You will not be held responsible for loss or damage to vehicle or articles left in vehicle in case of fire, theft, accident or any other cause beyond your control. In the event an attorney is retained to foreclose this lien or to bring suit for collection of any sums due I agree to pay costs of collection and reasonable attorney fees.

Authorized By: P. Hu... CUSTOMER ACKNOWLEDGES RECEIPT OF A COPY HEREOF DATE: \_\_\_\_\_ TIME: \_\_\_\_\_

ESTIMATE:  
 INSPECTION FEE 36.75 + 10.00  
 CERTIFICATE IF ISSUED 8.25  
 RETURN OLD PARTS

**TOTAL ESTIMATE 105.00**

I ACKNOWLEDGE NOTICE AND ORAL APPROVAL OF AN INCREASE IN THE ORIGINAL ESTIMATED PRICE.

X INITIALS \_\_\_\_\_

ESTIMATED COST \$ OF ADDITIONAL REPAIR DATE TIME IND. CONTACTED PHONE NO.

TOTAL LABOR	
PARTS	
OIL & FLUIDS	
SUB-TOTAL	
TAX	
GAS / GAL.	
<b>TOTAL AMOUNT</b>	105.00



# Smog Check Vehicle Inspection Report (VIR)



www.esp-global.com

www.autorepair.ca.gov

Test Date/Time: 05/02/2023@09:05:34

Model Year: 1988	Make: CHEVROLET	Model: K20 SUBURBAN
License: 2JHY101	State: CA	VIN: 1GNCR26N3JF131139
Engine Size: 7.40 L	Type: Truck	Transmission: Automatic
GVWR: 8600	Test Weight: 5000	Cylinders: 8
Odometer: 51,479	Certification: California	VLT Record #: 19935
Fuel Type: Gasoline	Exhaust: Single	Inspection Reason: High Emitter Profile

## Overall Test Results

Congratulations! Your vehicle passed the enhanced Smog Check inspection, which helps California reach its daily goal of removing an extra 100 tons of smog-forming emissions from the air. Thank you for keeping your vehicle well maintained.

Smog Check Certificate Number: TE512054

DMV ID Number: 3385E414T389

Your Smog Check certificate has been electronically transmitted to DMV.

Your certificate is valid for 90 days from date of issuance.

Please keep this copy for your records.

## Emission Control Systems Visual Inspection/Functional Check Results

(Visual/Functional tests are used to assist in the identification of crankcase and cold start emissions which are not measured during the ASM test.)

Result	ECS	Result	ECS	Result	ECS
Pass	PCV	Pass	Thermostatic Air Cleaner	Pass	Fuel Evaporative Controls
Pass	Catalytic Converter	Pass	Air Injection	Pass	OBD System Checks
Pass	EGR Visual	Pass	Vacuum Lines to Sensors / Switches	Pass	Carb. / Fuel Injection
Not applicable	EGR Functional	Pass	Ignition Timing: PB05	Pass	Other Emission Related Components
Pass	Fuel Cap Functional	Pass	Wiring to Sensors	Pass	Oxygen Sensor
Pass	Fuel Cap Visual	Not applicable	Fillpipe Restrictor	Pass	Liquid Fuel Leaks
Pass	Spark Controls	Pass	Fuel Evaporative Controls Functional		

## ASM Emission Test Results

Test	RPM	%CO2		%O2			HC (PPM)			CO (%)			NO (PPM)			Results
		MEAS	MEAS	MAX	AVE	MEAS	MAX	AVE	MEAS	MAX	AVE	MEAS	MAX	AVE	MEAS	
15 mph	1373	15.4	0.0	95	35	17	0.95	0.20	0.15	1552	327	83	Pass			
25 mph	1360	15.5	0.0	108	29	14	1.13	0.22	0.08	1517	330	31	Pass			

MAX = Maximum Allowable Emissions

AVE = Average Emissions For Passing Vehicles

MEAS = Amount Measured

## Smog Check Inspection Station Information

THE SMOG CENTER, INC.  
 968 PINER ROAD #B SANTA ROSA, CA 95403  
 (707)546-SMOG  
 Station Number: TC231510

Technician Name/Number: RODIGOU, KATHARINA/EO630667  
 Repair Tech Name/Number:  
 Software Version/EIS Number: 2201 / EP729488

I certify, under penalty of perjury, under the laws of the State of California, that I performed the inspection in accordance with all bureau requirements, and that the information listed on this vehicle inspection report is true and accurate.

Date 5-2-23

Technician's Signature

090541



**THE SMOG CENTER, INC.**

968 B Piner Road  
 SANTA ROSA, CA 95403  
 (707) 546-SMOG (7664)  
 BAR# ARD231510



5-10-21

Date 5-12-21  
 Time Received \_\_\_\_\_  
 \_\_\_\_\_ A.M.  
 \_\_\_\_\_ P.M.  
 Promised \_\_\_\_\_ A.M.  
 \_\_\_\_\_ P.M.  
 Written By \_\_\_\_\_

Address: \_\_\_\_\_ Apt. No. \_\_\_\_\_  
 Santa Rosa, CA 95409  
 Model: 1995 Chevy Silverado Odometer: 50895  
 License No. 25H4121

AMOUNT	REPAIR ORDER LABOR INSTRUCTION	INTERNAL
	I/M SMOG INSPECTION	86.71
	I/M SMOG CERTIFICATE	8.25
	EVAP TEST (1976 - 1995 Vehicles Only)	
	Fed/Cal <input checked="" type="radio"/> Auto/Man <input checked="" type="radio"/> BI/Change of Owner <input checked="" type="radio"/> Eng Size <u>7.4</u>	
TEST ONLY facility & can NOT perform any repairs or adjustments to your vehicle if it fails.		
Smog Inspection Fee is Due Whether Your Vehicle Passes, Fails, Or The Test is Aborted.		

CONTROL DEVICES MAY STILL BE COVERED UNDER MFG.'S  
 DEFECTIVE EQUIPMENT WARRANTY. IF A DEFECTIVE EQUIPMENT  
 CHECK TEST INDICATES ARE NECESSARY.

I hereby grant you and/or your employees, permission to operate the car, truck or vehicle herein described  
 as mechanic's lien is hereby acknowledged on above car, truck or vehicle to secure the amount of repairs  
 to vehicle in case of fire, theft, accident or any other cause beyond your control. In the event an attorney is  
 pay costs of collection and reasonable attorney fees.

5-10-2021

REGISTRATION DATE TIME

TOTAL LABOR	
PARTS	
OIL & FLUIDS	
SUB-TOTAL	
TAX	
GAS / GAL.	
<b>TOTAL AMOUNT</b>	<u>95.-</u>

RETURN OLD PARTS  Y  N

I ACKNOWLEDGE NOTICE AND ORAL APPROVAL OF AN  
 INCREASE IN THE ORIGINAL ESTIMATED PRICE.

X INITIALS \_\_\_\_\_

TIME \_\_\_\_\_ IND. CONTACTED \_\_\_\_\_ PHONE NO. \_\_\_\_\_

(3)  
 FILE COPY



www.esp-global.com

# Smog Check Vehicle Inspection Report (VIR)



www.autorepair.ca.gov

## Vehicle Information

Test Date/Time: 05/10/2021@09:12:32

Model Year:	1988	Make:	CHEVROLET	Model:	K20 SUBURBAN
License:	2JHY101	State:	CA	VIN:	1GNCR26N3JF131139
Engine Size:	7.40 L	Type:	Truck	Transmission:	Automatic
GVWR:	8600	Test Weight:	5000	Cylinders:	8
Odometer:	50,895	Certification:	California	VLT Record #:	19935
Fuel Type:	Gasoline	Exhaust:	Single	Inspection Reason:	1.9% Random Sample

## Overall Test Results

Congratulations! Your vehicle passed the enhanced Smog Check inspection, which helps California reach its daily goal of removing an extra 100 tons of smog-forming emissions from the air. Thank you for keeping your vehicle well maintained.

Smog Check Certificate Number: SA394269

DMV ID Number: 3881A418S589

Your Smog Check certificate has been electronically transmitted to DMV.

Your certificate is valid for 90 days from date of issuance.

Please keep this copy for your records.

## Emission Control Systems Visual Inspection/Functional Check Results

(Visual/Functional tests are used to assist in the identification of crankcase and cold start emissions which are not measured during the ASM test.)

Result	ECS	Result	ECS	Result	ECS
Pass	PCV	Pass	Thermostatic Air Cleaner	Pass	Fuel Evaporative Controls
Pass	Catalytic Converter	Pass	Air Injection	Pass	OBD System Checks
Pass	EGR Visual	Pass	Vacuum Lines to Sensors / Switches	Pass	Carb. / Fuel Injection
Not applicable	EGR Functional	Pass	Ignition Timing: PB03	Pass	Other Emission Related Components
Pass	Fuel Cap Functional	Pass	Wiring to Sensors	Pass	Oxygen Sensor
Pass	Fuel Cap Visual	Not applicable	Fillpipe Restrictor	Pass	Liquid Fuel Leaks
Pass	Spark Controls	Pass	Fuel Evaporative Controls Functional		

## ASM Emission Test Results

Test	RPM	%CO2		%O2		HC (PPM)		CO (%)			NO (PPM)			Results
		MEAS	MEAS	MAX	AVE	MEAS	MAX	AVE	MEAS	MAX	AVE	MEAS		
15 mph	1372	15.1	0.1	95	35	27	0.95	0.20	0.20	1552	327	170	Pass	
25 mph	1322	15.2	0.0	108	29	20	1.13	0.22	0.19	1517	330	67	Pass	

MAX = Maximum Allowable Emissions

AVE = Average Emissions For Passing Vehicles

MEAS = Amount Measured

## Smog Check Inspection Station Information

THE SMOG CENTER, INC  
 968 PINER ROAD #B SANTA ROSA, CA 95403  
 (707)546-7664  
 Station Number: TC231510

Technician Name/Number: RODIGOU, KATHARINA/EO630667  
 Repair Tech Name/Number:  
 Software Version/EIS Number: 1905 / EP729488

I certify, under penalty of perjury, under the laws of the State of California, that I performed the inspection in accordance with all bureau requirements, and that the information listed on this vehicle inspection report is true and accurate.

Date

5.10.21

Technician's Signature



# Larsen Auto Care

940 Petaluma Hill Rd, Santa Rosa, CA 95404  
Phone: 707-535-0720  
BAR# ARD00283685  
EPA# CAL000367517



RO#: 1027199  
Invoiced: 08/01/2019

Page: 1

## Customer:

Santa Rosa, CA 95409  
Pn: (?)

## Vehicle:

1988 Chevrolet Suburban R20 RWD  
Eng: V8-454 7.4L OHV Tran: Automatic  
VIN: 1GNGR26N3JF131139  
Mileage In: 50389 Out:             
P Date: Cir: White  
Lic: 2JHY101 St: CA

## Repair Order:

Service Writer: F Counter  
PO Number:  
Date In: 07/30/2019  
Date Out: 08/01/2019  
Driver:

## Recommendations

Customer Concern: Maintenance Inspection  
Diagnosis: Transmission pan leaking & 1 bolt missing, A/C inop  
Recommendation: Transmission service & 1 bolt, diagnose A/C  
Labor: No labor on job  
Parts: No parts on job

Job Sub Total: 0.00

## Oil Change

Customer Concern: Oil change

Labor:	Description	Extended
	Changed engine oil & filter. Perform lube. Topped off washer fluid	20.00
	Replace dirty air filter	58.00

Labor Sub Total: 78.00

Parts:	Part Num	Cond	Description	Price Ea.	Qty	Extended
	21060MP	N	Oil Filter	7.99	1.00	7.99
	22001310	N	Chev Supreme Engine Oil SAE 5W30 SBlend	3.95	7.00	27.65
	22098	N	Air Filter	7.44	1.00	7.44
	728031	N	Terminal Bolt - Short	4.81	1.00	4.81

Parts Sub Total: 47.89

Job Sub Total: 125.89

## Engine Mechanical

Customer Concern: Check engine light - intermittent when under load

I hereby authorize the repair work below to be done along with the necessary material, and hereby grant you and/or your employees permission to operate the car, truck or vehicle herein described on streets, highways or elsewhere for the purpose of testing and/or inspection. An express mechanic's lien is hereby acknowledged on above car, truck or vehicle to secure the amount of repairs thereto. We will not be held responsible for loss or damage to vehicle or articles left in vehicle in case of fire, theft, accident or any other cause beyond your control. Warranty on new parts & labor is two years or 24,000 miles whichever comes first. Warranty work has to be performed in our shop & cannot exceed the original cost of repair.

Parts:	311.47
Labor:	469.50
Sublets:	0.00
Misc:	10.00
<b>Subtotal:</b>	<b>790.97</b>
Tax1:	28.03
Tax2:	0.00
<b>TOTAL:</b>	<b>819.00</b>
Balance:	819.00

Customer Signature

Date



# Larsen Auto Care

940 Petaluma Hill Rd, Santa Rosa, CA 95404  
Phone: 707-535-0720  
BAR# ARD00283685  
EPA# CAL000367517



RO#: 1027199  
Invoiced: 08/01/2019

Page: 2

## Customer:

Santa Rosa, CA 95409  
Pn: (707) 535-0720

## Vehicle:

1988 Chevrolet Suburban R20 RWD  
Eng: V8-454 7.4L OHV Tran: Automatic  
VIN: 1GNCR26N3JF131139  
Mileage In: 50389 Out:  
P Date: Clr: White  
Lic: 2JHY101 St: CA

## Repair Order:

Service Writer: F Counter  
PO Number:  
Date In: 07/30/2019  
Date Out: 08/01/2019  
Driver:

Labor:	Description	Extended
	Scan for codes, DTC #33 MAP sensor or circuit too high. Check data stream & MAP voltages. Access & check vacuum source, OK. Test MAP sensor inputs & outputs. MAP sensor out of range. Recommend MAP sensor	145.00
	Replace MAP sensor, cleared codes & road test	116.00
<b>Labor Sub Total:</b>		<b>261.00</b>

Parts:	Part Num	Cond	Description	Price Ea.	Qty	Extended
	PS10075	N	MAP Sensor	151.09	1.00	151.09
<b>Parts Sub Total:</b>						<b>151.09</b>
<b>Job Sub Total:</b>						<b>412.09</b>

## Brakes

Customer Concern: Brake master cylinder

Labor:	Description	Extended
	Brake master cylinder leaking. Replace brake master cylinder	130.50
<b>Labor Sub Total:</b>		<b>130.50</b>

Parts:	Part Num	Cond	Description	Price Ea.	Qty	Extended
	M2423	N	Brake Master	96.21	1.00	96.21
	Brake Fluid 35012	N	Dot 3 Brake Fluid	8.14	2.00	16.28
<b>Parts Sub Total:</b>						<b>112.49</b>
<b>Job Sub Total:</b>						<b>242.99</b>

## Tire Pressure

Diagnosis: Tire Pressure  
Fronts 60 Rears 70

Labor: No labor on job

Parts: No parts on job

Misc:	Description	Sold Price	Qty	Extended
	Environmental Fee	10.00	1.00	10.00
<b>Misc Sub Total:</b>				<b>10.00</b>
<b>Job Sub Total:</b>				<b>10.00</b>

## Contact Log

As of 08/01/2019 at 4:20 pm



# Larsen Auto Care

940 Petaluma Hill Rd, Santa Rosa, CA 95404  
Phone: 707-535-0720  
BAR# ARD00283685  
EPA# CAL000367517



RO#: 1027199  
Invoiced: 08/01/2019

Page: 3

### Customer:

V  
393  
Santa Rosa, CA 95409  
Pn: (7 .9

### Vehicle:

1988 Chevrolet Suburban R20 RWD  
Eng: V8-454 7.4L OHV Tran: Automatic  
VIN: 1GNR26N3JF131139  
Mileage In: 50389 Out:  
P Date: Clr: White  
Lic: 2JHY101 St: CA

### Repair Order:

Service Writer: F Counter  
PO Number:  
Date In: 07/30/2019  
Date Out: 08/01/2019  
Driver:

Date:	Time:	By:	Method: # / Addr:	Auth By:	Additional Amt:	Revised Estimate:
07/30/2019	9:02 am	F Counter	Initial Contact -	Van Noy, Betty		145.00
07/31/2019	10:40 am	R Larsen	Phone Oil change, diagnose, MAP sensor, air filter	Van Noy, Betty	522.00	667.00
07/31/2019	2:40 pm	R Larsen	Phone Master brake cylinder	Van Noy, Betty	277.00	944.00

I acknowledge notice and oral approval of an increase in the original estimated price.

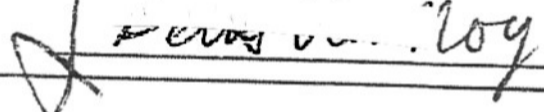
Signature: 

### Payments

As of 08/01/2019 at 4:20 pm

Transactions: No payments received.

2019 Water Pump

149,000

Miguel's Auto Service  
3181 Coffey Ln #B  
Santa Rosa, Ca 95403  
707-623-9852  
ARDD00256826

MATERIAL USED			
QTY.	PART NO.	DESCRIPTION	PRICE
1		Water Pump	57.99
1		Antifreeze	14.88
TOTAL PARTS			72.87
TOTAL ACCESSORIES			
TOTAL ACCESSORIES			

NAME: \_\_\_\_\_  
ADDRESS: \_\_\_\_\_ Ave  
2ND AUTHORIZED NAME: \_\_\_\_\_  
PHONE: \_\_\_\_\_  
MAKE: Chevy TYPE OR MODEL: Suburban YEAR: 1988  
SERIAL #/VIN: \_\_\_\_\_ ENGINE NO.: \_\_\_\_\_  
RECEIVED (DATE & TIME): \_\_\_\_\_ A.M./P.M.  
PROMISED (DATE & TIME): \_\_\_\_\_ A.M./P.M.  
ODOMETER: 149,000 LICENSE NO.: 2JH P 101 TERMS: \_\_\_\_\_  
PHONE WHEN READY:  YES  NO  
MW#: \_\_\_\_\_ ORDER WRITTEN BY: \_\_\_\_\_ CUSTOMER'S ORDER NO.: \_\_\_\_\_

INSTRUCTIONS: CHARGE FOR HAZARDOUS OR OTHER WASTE REMOVAL\*  
LUBRICATION   
CHANGE OIL   
CHANGE OIL FILTER CART.   
CHANGE TRANS.   
CHANGE DIFF.   
PACK FRONT WHEEL BRGS   
ADJUST BRAKES   
ROTATE TIRES   
WASH POLISH   
STATE INSPECTION

OPER. NO. \_\_\_\_\_ INSTRUCTIONS: \_\_\_\_\_  
Estimated cost \$ \_\_\_\_\_ Estimate Charge \_\_\_\_\_  
Basis for Charge \_\_\_\_\_  
PLEASE READ CAREFULLY, CHECK ONE OF THE STATEMENTS BELOW, AND SIGN:  
I UNDERSTAND THAT, UNDER STATE LAW, I AM ENTITLED TO A WRITTEN ESTIMATE, INCLUDING A COMPLETION DATE, IF MY FINAL BILL WILL EXCEED \$100. (\$50 in Maryland)  
I REQUEST A WRITTEN ESTIMATE. THE FINAL BILL MAY NOT EXCEED THIS ESTIMATE WITHOUT MY WRITTEN APPROVAL.  
I DO NOT REQUEST A WRITTEN ESTIMATE, AS LONG AS THE REPAIR COSTS DO NOT EXCEED \$ \_\_\_\_\_. THE SHOP MAY NOT EXCEED THIS AMOUNT WITHOUT MY WRITTEN OR ORAL APPROVAL.  
I DO NOT REQUEST A WRITTEN ESTIMATE.

You are entitled by law to the return of all parts replaced, except those for which there is a core charge, unless you agree otherwise by initiating the following: \_\_\_\_\_ I do not desire the return of any of the parts that are replaced during the authorized repairs.  
Estimate good for 30 days. Not responsible for damage caused by theft, fire, or acts of nature. I authorize the above repairs, along with any necessary materials. I authorize you and your employees to operate my vehicle for the purpose of testing, inspection, and delivery at my risk. An express mechanic's lien is hereby acknowledged on the above vehicle to secure the amount of the repairs thereto. If I cancel repairs prior to their completion for any reason, a tear-down and reassembly fee of \$ \_\_\_\_\_ will be applied.

SIGNED: \_\_\_\_\_  
DATE: 2-11-19

\*Checked lines apply (Preparer must check at least one):  
This charge represents costs and profits to the motor vehicle repair facility for miscellaneous shop supplies or waste disposal.  
This amount includes a charge of \$ \_\_\_\_\_, which is required under law.

METHOD OF PAYMENT:  CASH  CHECK  CHARGE  
LABOR:  FLAT RATE  HOURLY  BOTH  
 RETAIN PARTS  DESTROY PARTS

GAS, OIL, & GREASE	PRICE
GALS. GAS @	
QTS. OIL @	
LBS. GREASE @	
TOTAL GAS, OIL, & GREASE	

TOTAL LABOR	180.00
TOTAL PARTS	72.87
ACCESSORIES	
GAS, OIL, & GREASE	
OUTSIDE REPAIRS	
STORAGE FEE (if applies)	
TAX	6.28
TOTAL AMOUNT	259.15



# PLATINUM CHEVROLET *Santa Rosa*

3001 Corby Avenue · Santa Rosa, CA 95407

(707) 525-1800

www.platinum-chevy.com

*2017-2-21*

NO RETURNS WITHOUT THIS INVOICE  
 NO RETURNS AFTER 10 DAYS  
 NO RETURNS ON SPECIAL ORDER OR ELECTRICAL ITEMS  
 A RESTOCKING CHARGE WILL BE APPLIED ON ALL OTHER RETURNED MERCHANDISE

### DISCLAIMER OF WARRANTIES

Any warranties on the products sold hereby are those made by the manufacturer. The seller hereby expressly disclaims all warranties, either express or implied, including any implied warranty of merchantability or fitness for a particular purpose, and the seller neither assumes nor authorizes any other person to assume for it any liability in connection with the sale of said products.

DATE ENTERED 07 JUL 17	YOUR ORDER NO.	DATE SHIPPED 07 JUL 17	INVOICE DATE	INVOICE NUMBER Q113256	15:09:
---------------------------	----------------	---------------------------	--------------	---------------------------	--------

\*\*QUOTE\*\*

S  
O  
L  
D  
T  
O

ACCOUNT NO. P101

RETAIL CASH

S  
H  
I  
P  
T  
O

PAGE 1 OF 1

SHIP VIA	SLSM. 5227	B/L NO. MICHAEL BAKER	TERMS CASH	F.O.B. POINT
QTY	QTY	QTY	QTY	QTY
1	1	0		
15614709	NS	F- (S) BOLT	11.85	11.85
**** I N V O I C E Q U O T E -			DO NOT	PAY ****
<p><i>M8x1.25x20</i></p> <p><i>Fastenal</i></p> <p><i>SR Ave.</i></p>			<i>3715</i>	<i>SR Ave</i>
				<i>#1</i>
<p>WARNING!!! PARTS ARE NOT RETURNABLE                  IF YOU DEFACE THE PACKAGING.                  ALL RETURNS PAID BY CASH OR CHECK                  WILL BE REFUNDED BY CHECK AND SUBJECT                  TO TEN DAY WAIT PERIOD.</p>			PARTS	11.85
			SUBLET	
			FREIGHT	0.00
			SALES TAX	1.02
CUSTOMER'S SIGNATURE				
X			TOTAL	\$12.87

*Thank You!*

*We Appreciate Your Patronage*



# Larsen Auto Care

940 Petaluma Hill Rd, Santa Rosa, CA 95404  
Phone: 707-535-0720  
BAR# ARD00283685  
EPA# CAL000367517



RO#: 1023033  
Invoiced: 09/01/2017

Page: 1

### Customer:

393  
Santa Rosa, CA 95409  
Pn: (70

### Vehicle:

1988 Chevrolet Suburban R20 RWD  
Eng: V8-454 7.4L OHV Tran: Automatic  
VIN: 1GNGR26N3JF131139  
Mileage In: 48798 Out:  
P Date: Clr: White  
Lic: 2JHY101 St: CA

### Repair Order:

Service Writer: A  
PO Number:  
Date In: 08/31/2017  
Date Out: 09/01/2017  
Driver:

## Recommendations

**Customer Concern:** Maintenance Inspection  
**Diagnosis:** Transmission pan leaking & 1 bolt missing, A/C inop  
**Recommendation:** Transmission service & 1 bolt, diagnose A/C

## Suspension and Steering

**Customer Concern:** Check shocks - wants heavy duty & box

Labor:	Description	Extended				
	Left rear shock leaking. Replace both rear shocks	91.00				
<b>Labor Sub Total:</b>		91.00				
Parts:	Part Num	Cond	Description	Price Ea.	Qty	Extended
	76824	N	Shock	104.36	2.00	208.72
<b>Parts Sub Total:</b>						208.72
Misc:	Description	Sold Price	Qty	Extended		
	Environmental Fee	10.00	1.00	10.00		
<b>Misc Sub Total:</b>				10.00		
<b>Job Sub Total:</b>				309.72		

## Tire Pressure

**Diagnosis:** Tire Pressure  
Fronts 60 Rears 70

**Labor:** No labor on job

**Parts:** No parts on job

I hereby authorize the repair work below to be done along with the necessary material, and hereby grant you and/or your employees permission to operate the car, truck or vehicle herein described on streets, highways or elsewhere for the purpose of testing and/or inspection. An express mechanic's lien is hereby acknowledged on above car, truck or vehicle to secure the amount of repairs thereto. We will not be held responsible for loss or damage to vehicle or articles left in vehicle in case of fire, theft, accident or any other cause beyond your control. Warranty on new parts & labor is two years or 24,000 miles whichever comes first. Warranty work has to be performed in our shop & cannot exceed the original cost of repair.

<b>Parts:</b>	208.72
<b>Labor:</b>	91.00
<b>Sublets:</b>	0.00
<b>Misc:</b>	10.00
<b>Subtotal:</b>	309.72
<b>Tax1:</b>	18.00
<b>Tax2:</b>	0.00
<b>TOTAL:</b>	327.72
<b>Balance:</b>	0.00

Customer Signature

Date



# Larsen Auto Care

940 Petaluma Hill Rd, Santa Rosa, CA 95404  
Phone: 707-535-0720  
BAR# ARD00283685  
EPA# CAL000367517



RO#: 1023033  
Invoiced: 09/01/2017

Page: 2

### Customer:

393... ave  
Santa Rosa, CA 95409  
Pn: (7...

### Vehicle:

1988 Chevrolet Suburban R20 RWD  
Eng: V8-454 7.4L OHV Tran: Automatic  
VIN: 1GN GR26N3JF131139  
Mileage In: 48798 Out:  
P Date: Clr: White  
Lic: 2JHY101 St: CA

### Repair Order:

Service Writer: A  
PO Number:  
Date In: 08/31/2017  
Date Out: 09/01/2017  
Driver:

Job Sub Total: 0.00

## Contact Log

As of 09/01/2017 at 12:18 pm

Date:	Time:	By:	Method:	# / Addr:	Auth By:	Additional Amt:	Revised Estimate:
08/31/2017	8:05 am	A	Initial		Van Noy, Betty		130.00
			Contact -				
08/31/2017	9:26 am	M Ussery	Phone		Van Noy, Betty	224.00	354.00
		Rear shocks					

I acknowledge notice and oral approval of an increase in the original estimated price.

Signature: \_\_\_\_\_

## Payments

As of 09/01/2017 at 12:18 pm

Transactions:	LedgerId:	Date:	Accepted By:	Method:	Type/Check#:	Amount:
Payment	164483	09/01/2017	Admin	Online Pmt	Credit Card	327.72



# Larsen Auto Care

940 Petaluma Hill Rd, Santa Rosa, CA 95404  
 Phone: 707-535-0720  
 BAR# ARD00283685  
 EPA# CAL000367517



RO#: 1022639  
 Invoiced: 07/06/2017

Page: 1

### Customer:

5,  
 Santa Rosa, CA 95409  
 Pn:

### Vehicle:

1988 Chevrolet Suburban R20 RWD  
 Eng: V8-454 7.4L OHV Tran: Automatic  
 VIN: 1GNGR26N3JF131139  
 Mileage In: 148382 Out:  
 P Date: Clr: White  
 Lic: 2JHY101 St: CA

### Repair Order:

Service Writer: A  
 PO Number:  
 Date In: 07/06/2017  
 Date Out: 07/06/2017  
 Driver:

## Recommendations

**Customer Concern:** Maintenance Inspection  
**Diagnosis:** Transmission pan leaking & 1 bolt missing, left rear shock leaking, A/C inop  
**Recommendation:** Transmission service & 1 bolt, rear shocks, diagnose A/C

## Cooling System

**Customer Concern:** Possible heater core. Leaking coolant interior

Labor:	Description	Extended
	Check for leak, heater core leaking. Replace heater core	455.00
	Topped off brake, power steering & washer fluids	0.00
<b>Labor Sub Total:</b>		455.00

Parts:	Part Num	Cond	Description	Price Ea.	Qty	Extended
	660-3046	N	Heater core	65.23	1.00	65.23
	Coolant	N	Antifreeze / Coolant - Green	19.50	1.00	19.50
<b>Parts Sub Total:</b>						84.73

Misc:	Description	Sold Price	Qty	Extended
	Environmental Fee	10.00	1.00	10.00
<b>Misc Sub Total:</b>				10.00
<b>Job Sub Total:</b>				549.73

## Tire Pressure

**Diagnosis:** Tire Pressure  
 Fronts 36 Rears 36

I hereby authorize the repair work below to be done along with the necessary material, and hereby grant you and/or your employees permission to operate the car, truck or vehicle herein described on streets, highways or elsewhere for the purpose of testing and/or inspection. An express mechanic's lien is hereby acknowledged on above car, truck or vehicle to secure the amount of repairs thereto. We will not be held responsible for loss or damage to vehicle or articles left in vehicle in case of fire, theft, accident or any other cause beyond your control. Warranty on new parts & labor is two years or 24,000 miles whichever comes first. Warranty work has to be performed in our shop & cannot exceed the original cost of repair.

**Parts:** 84.73  
**Labor:** 455.00  
**Sublets:** 0.00  
**Misc:** 10.00  
**Subtotal:** 549.73  
**Tax1:** 7.31  
**Tax2:** 0.00  
**TOTAL:** 557.04  
**Balance:** 0.00

Customer Signature

Date



# Larsen Auto Care

940 Petaluma Hill Rd, Santa Rosa, CA 95404  
Phone: 707-535-0720  
BAR# ARD00283685  
EPA# CAL000367517



RO#: 1022639  
Invoiced: 07/06/2017

Page: 2

## Customer:

Van Noy  
Santa Rosa, CA 95409  
Pn: ( )

## Vehicle:

1988 Chevrolet Suburban R20 RWD  
Eng: V8-454 7.4L OHV Tran: Automatic  
VIN: 1GNGR26N3JF131139  
Mileage In: 148382 Out:  
P Date: Clr: White  
Lic: 2JHY101 St: CA

## Repair Order:

Service Writer: A  
PO Number:  
Date In: 07/06/2017  
Date Out: 07/06/2017  
Driver:

Labor: No labor on job  
Parts: No parts on job

Job Sub Total: 0.00

## Contact Log

As of 07/06/2017 at 5:00 pm

Date:	Time:	By:	Method:	# / Addr:	Auth By:	Additional Amt:	Revised Estimate:
07/06/2017	7:53 am	A	Initial Contact -		Van Noy, Betty		130.00
07/06/2017	9:47 am	R Larsen	Phone		Van Noy, Betty	476.00	606.00

I acknowledge notice and oral approval of an increase in the original estimated price.

Signature: \_\_\_\_\_

## Payments

As of 07/06/2017 at 5:00 pm

Transactions:	LedgerId:	Date:	Accepted By:	Method:	Type/Check#:	Amount:
Payment	159566	07/06/2017	Admin	Online Pmt	Visa	557.04

# VALLEY TIRE & BRAKE

1688 PINER ROAD, SANTA ROSA, CA 95403  
 (707) 544-3420 • (800) 300-6696 • www.valleytire.com  
 ENGINE MAINTENANCE (707) 521-2847

MICHELIN • BFGoodrich  
 UNIROYAL • DUNLOP • Continental

EPA #CAL000072981  
 BAR #AJ036777

4-24-17

Tires • Brakes • Alignment • Steering • Trailer Hitches  
 Suspension • Struts • Shocks • Smog • Custom Wheels  
 Tune Ups • Diagnostics • Problem Solving  
 Mufflers & Exhaust Repair

Free Courtesy Cars • Since 1968

INVOICE #: 10173486

PAGE: 1  
 TIME STARTED: 09:57:55  
 TIME CLOSED: 11:36:37

CUSTOMER: BE... TV  
 1...  
 ... Z

PRIMARY: 7... 0 VEHICLE: 1988 CHEVROLET R20 SUBURBAN  
 SALESMAN: ERIC OFFENBACHER LICENSE: 2JHY101 CA MILEAGE: 48139  
 ENGINE: 7.4L V8 FI  
 VIN: 1GNR26N3JF131139  
 Fleet ID 12/87 AT AC  
 INVOICE DATE: 04/24/17 DUE: 04/24/17

PRODUCT	QUANTITY	PRICE	F.E.T.	EXTENSION
SMOG INSPECTION-AAA MEMBER SIA	1	77.75		77.75
SMOG CERTIFICATE SC	1	8.25		8.25
SET TIRE PRESSURES PER CA A.R.B. PSI	1			8.00
SET TIRE PRESSURES TO 44PSI FRONT / 80PSI REAR				
		MERCHANDISE:		8.25
		LABOR:		77.75
		INVOICE TOTAL:		86.00
		VISA		86.00

TENDERED BY 2

ORIGINAL ESTIMATE OF REPAIRS: \$ \_\_\_\_\_ PLUS TAX  
 Includes all parts, labor, handling and diagnosis. If on closer analysis it is found that additional repairs are necessary, you will be contacted for authorization pursuant to Division 3, Chapter 20.3, Article Sec. 9884.9 of the California Business and Professions Code. All parts are new unless specified otherwise. IF THE AUTOMOBILE IS RETURNED TO CUSTOMER BEFORE AUTHORIZED SERVICE IS PERFORMED, A DIAGNOSIS AND HANDLING CHARGE WILL BE MADE. Because of the extent of the tear down and inspection, the vehicle may not perform as well as before.

I have read and understand the above estimate and terms. I authorize service to be performed including sublet work, road test and acknowledge receipt of this estimate.

CUSTOMER SIGNATURE Butch Van Noy DATE \_\_\_\_\_ / \_\_\_\_\_ / \_\_\_\_\_

WARRANTY on parts and labor are 90 days or 4,000 miles, whichever comes first unless otherwise noted on invoice. Installed parts are not warranted beyond that given by manufacturer. All warranty items must be returned with invoice within warranty period for exchange or credit. Any warranty, parts or labor honored only at Valley Tire & Brake, Santa Rosa, California.

# SMOG CHECK VEHICLE INSPECTION REPORT

(04/24/2017 @ 10:51:27 am)

## Vehicle Information

Model Year..... 1988	Make..... CHEVROLET	Model..... R20 SUBURBAN 2WD
License..... 2JHY101	State..... California	VIN..... 1GNGR26N3JF131139
Engine Size..... 7.4 Liters	Type..... Truck	Transmission..... Automatic
GVWR..... 8600 lbs.	Test Weight..... 6000 lbs.	Cylinders..... 8
Odometer..... 48139	Certification..... California	VLT Record #..... 1220
Fuel Type..... Gasoline	Exhaust..... Single	Inspection Reason..... HEP
Engine Year..... N/A	Engine Make..... N/A	Bar Number..... N/A
Fleet BAR File #..... N/A		

## Overall Test Results

Congratulations! Your vehicle passed the enhanced Smog Check inspection, which helps California reach its daily goal of removing an extra 100 tons of smog-forming emissions from the air. Thank you for keeping your vehicle well maintained.

Visual Inspection..(Pass) Functional Check..(Pass) Emissions Test..(Pass)

DMV ID Number..(3001P117Z399)  
Smog Check Certificate Number..(ZP710977)

Your Smog Check certificate has been electronically transmitted to the DMV.  
This certificate is valid for ninety (90) days from the date of issuance.

Please keep this copy for your records.

## Emission Control Systems Visual Inspection/Functional Check Results

(Visual/Functional tests are used to assist the identification of oxides of nitrogen, crankcase, and cold start emissions which are not measured during the idle tests)

<u>ECS</u>	<u>Result</u>	<u>ECS</u>	<u>Result</u>	<u>ECS</u>	<u>Result</u>
FCV.....	Pass	Thermostatic Air Cleaner.....	Pass	Fuel Evaporative Controls.....	Pass
Catalytic Converter.....	Pass	EGR (Visual).....	Pass	Spark Controls.....	Pass
Fuel Injection.....	Pass	Pump Air Injection.....	Pass	Oxygen Sensor.....	Pass
Wiring to Sensors.....	Pass	Vacuum lines sensors/switches..	Pass	Other related emis. components.	Pass
Liquid Fuel Leak.....	Pass	Fuel Cap Integrity Test.....	Pass	Fuel Cap Visual.....	Pass
OBI System Check.....	Pass	Ignition Timing (05 BTDC).....	Pass	Fuel EVAP Test.....	Pass

## ASM Emission Test Results

Test	RPM			%CO2			HC (PPM)			CO (%)			NO (PPM)			Result
	MEAS	MEAS	MEAS	MAX	AVE	MEAS	MAX	AVE	MEAS	MAX	AVE	MEAS	MAX	AVE	MEAS	
M1: 15 MPH	1453	14.5	0.1	130	41	25	1.30	0.11	0.46	2200	1018	91			Pass	
M2: 25 MPH	1417	14.8	0.0	103	29	12	1.55	0.07	0.12	2150	928	49			Pass	

MAX = Maximum Allowed Emissions    AVE = Average Emissions For Passing Vehicles    MEAS = Amount Measured

## Smog Check Station Information

VALLEY TIRE AND BRAKE  
1688 PINER RD  
SANTA ROSA, CA 95403  
1 707 544 3420

Technician Name/Number..... MEDEIROS, ANTONIO/E0138015  
Repair Tech Name/Number..... N/A  
Software Version/EIS Number... 1401/SX100109  
Station Number..... RJ036777

I certify under penalty of perjury under the laws of the State of California, that I performed the inspection in accordance with all bureau requirements, and that the information listed on this vehicle inspection report is true and correct.

4/24/17

Date

Technician's Signature

VANNOY, B

1988 CHEVROLET SUBERBAN

32948



NAME			REPAIR ORDER
ADDRESS			32948
CITY	STATE	ZIP	HOME PHONE
SANTA ROSA	CA	95409	389
ESTIMATE	EST. COMPLETION DATE		WORK PHONE
44010			

**MAACO COLLISION REPAIR & AUTO PAINTING**

CENTER: M0913  
 112 COMMERCIAL CT., STE 19  
 SANTA ROSA, CA 95407  
 EPA #CAD144-157435  
 CA BAR #AC1306080  
 TEL: (707) 578-8485 FAX: (707) 578-3121

ESTIMATE DATE 05/05/2015  
 ESTIMATOR SCOTT  
 BODY EMPLOYEE \_\_\_\_\_  
 PAINT EMPLOYEE \_\_\_\_\_

YEAR/MAKE/MODEL		
1988 CHEVROLET SUBERBAN		
LICENSE/STOCK NO.	STATE	VIN
2JHY101	CA	NO VIN
DATE IN	DATE OUT	<input type="checkbox"/> INS <input type="checkbox"/> TRADE & FLEET <input type="checkbox"/> WARRANTY
05/06/2015	05/15/2015	
PAINT COLOR:		
ALL WHITE		
MILEAGE IN:	OUT:	
466689		

SURFACE REPAIR	LIGHT CHIP & SCRATCH REPAIR	99.95
SEALERS	UNIVERSAL SEALER™	99.95
PROTECTION PACKAGES		
PAINT SERVICES	URETHANE + IC PAINT ALL ONE COLOR	1199.95
ADDITIONAL PAINT CHARGES	SUV/SW/P-UP/UTIL	350.00
OTHER PAINT OPTIONS	BODY SIDE MLDS NEW CHROME MOULDINGS	350.00
PAINT COMMENTS	CC#12	
SURFACE RECONDITIONING/ PAINT REMOVAL	EXTRA PREP PEELING PAINT AND CRACKING PAINT	1000.00

REPAIR	REPLACE	BODY REPAIR WORK	PART #	PRICE	GLASS	METAL	STRUCT	MECH	SUBLET	SPOT PAINT
1		NO BODYWORK WANTED								
2		check and advise REAR window not working								

MATERIALS & SUPPLIES	
REMARKS	RUST REPAIRS WARRANTED FOR 90 DAYS SOME IMPERFECTIONS WILL SHOW. IF FOUND, BODY FILLER WILL ADD WORK/COST TO REPAIR

PAINT	-2099.85	1499.95
SURFACE RECON	1000.00	
MATERIALS & SUPPLY	0.00	
PARTS	0.00	
BODY LABOR	0.00	
SUBLET/ENV	15.00	
SPOT PAINT	0.00	
GROSS SALES	-3114.85	2514.95
440.71	AMOUNT TAXABLE	
TAX	38.56	
TOTAL INCLUDING TAX	2553.51	
DEPOSIT:		
PAYMENTS		

**REPAIR ORDER**



# PAYMENT RECEIPT



**32948**

NAME _____			REPAIR ORDER <b>32948</b>
ADDRESS _____			
CITY <b>SANTA ROSA</b>	STATE <b>CA</b>	ZIP <b>95409</b>	WORK PHONE _____ _____ _____
ESTIMATE <b>44010</b>	EST. COMPLETION DATE _____		

**MAACO COLLISION REPAIR & AUTO PAINTING**

CENTER: M0913  
112 COMMERCIAL CT., STE 19  
SANTA ROSA, CA 95407  
EPA #CAD144-157435  
CA BAR #AC1306080  
TEL: (707) 578-8485 FAX: (707) 578-3121

ESTIMATE DATE 05/05/2015  
ESTIMATOR SCOTT  
BODY EMPLOYEE \_\_\_\_\_  
PAINT EMPLOYEE \_\_\_\_\_

YEAR/MAKE/MODEL <b>1988 CHEVROLET SUBERBAN</b>			
LICENSE/STOCK NO. <b>2JHY101</b>	STATE <b>CA</b>	VIN <b>NO VIN</b>	
DATE IN <b>05/06/2015</b>	DATE OUT <b>05/15/2015</b>	<input type="checkbox"/> INS	<input type="checkbox"/> TRADE & FLEET
PAINT COLOR: <b>ALL WHITE</b>			
MILEAGE IN: <b>466689</b>	OUT: _____		

**Charges**

Description	Gross	Taxable	Tax
Paint Service	1499.95	314.98	27.56
Surface Recon	1000.00	200.00	17.50
Sublet/Towing	15.00	0.00	0.00
<b>Total</b>	<b>2514.95</b>	<b>440.71</b>	<b>38.56</b>

**Payments**

Date	Type	Amount Paid

Total Due	2,553.51
Total Paid	0.00
Balance Due	2,553.51

**COMPLETION CERTIFICATE**

I HAVE INSPECTED MY VEHICLE AND AM SATISFIED THAT THIS SHOP HAS COMPLETED THE SERVICES ON THE REPAIR ORDER REFERENCED ABOVE. I HAVE ALSO RECEIVED A COPY OF THIS REPAIR ORDER

**X** \_\_\_\_\_

**PAYMENT INFORMATION**

**DEPOSITS/PAYMENT**

DATE \_\_\_\_\_ REC'D BY \_\_\_\_\_

METHOD OF PAYMENT	TOTAL INCL. TAX
CASH <input type="checkbox"/>	_____
CHECK <input type="checkbox"/>	DEPOSITS/PAYMENT
CREDIT CARD <input type="checkbox"/>	_____
BALANCE	

---

**PAYMENTS**

DATE \_\_\_\_\_ REC'D BY \_\_\_\_\_

CASH <input type="checkbox"/>	_____
CHECK <input type="checkbox"/>	PAYMENT
CREDIT CARD <input type="checkbox"/>	_____
BALANCE	

**NORCAL CAR CARE**

Order Date: 05/06/15 10:29 am

Work Order No.

**000035755**

BAR #: RC221870  
EPA# CAL 000248793  
1666 PINER ROAD  
SANTA ROSA, CA 95403  
Phone: 707-568-5080 FAX: 707-579-3034

26 9 2 5 LA Y 100D DR 18 Cell Phone: Work Phone:	88 CHEVROLET R20 SUBURBAN BL 46683 Mi. Lic: 2JHY101/CA V8Cyl 7.4 Eng Vin: 1GNGR26N3JF131139 Eq: AT AC PS FI
--	---

**BIENNIAL SMOG INSPECTION 99 - Labor: \$61.70**

BIENNIAL SMOG INSPECTION  
NOTICE: You may choose another smog check station to perform the needed repairs, installations, adjustments, or subsequent tests.

**Job Subtotal: \$69.95**

**Tire Inflation Service Declined Labor: \$0.00**

The customer declines the Tire Inflation service and affirms that  
a) the tire pressure services has been performed in the last 30 days .  
b) they will perform a tire pressure service within the next 7 days. .

**Job Subtotal: \$0.00**

Tire Inflation Service completed.  
Front: psi Rear: psi.

Tax: \$0.00  
Estimate Total: \$69.95

Thank you for choosing NORCAL CAR CARE

I HEREBY AUTHORIZE YOU TO PERFORM THE ABOVE REPAIRS AND FURNISH NECESSARY MATERIALS. I UNDERSTAND ANY COST QUOTED HERETOFORE IS AN ESTIMATE ONLY. YOUR EMPLOYEES MAY OPERATE VEHICLE FOR INSPECTION, TESTING, DELIVERY AT MY RISK. YOU WILL NOT BE RESPONSIBLE FOR LOSS OR DAMAGE TO VEHICLE OR ARTICLES LEFT IN IT. I AGREE TO PAY REASONABLE STORAGE ON VEHICLE LEFT MORE THAN 48 HOURS AFTER NOTIFICATION THAT REPAIRS ARE COMPLETED. AN EXPRESS MECHANIC'S LIEN IS ACKNOWLEDGED ON ABOVE VEHICLE TO SECURE THE AMOUNT OF REPAIRS THERETO, INCLUDING THOSE FROM ANY PRIOR WORK OR REPAIR CONTRACT ON THIS VEHICLE. IN THE EVENT AN ATTORNEY IS RETAINED TO FORECLOSE THIS LIEN OR TO BRING SUIT FOR COLLECTION OF ANY SUMS DUE, I AGREE TO PAY COSTS OF COLLECTION AND ANY REASONABLE ATTORNEY FEES. RECEIPT OF A COPY OF THIS ORDER IS HEREBY ACKNOWLEDGED.

(Signature) *Bill J. Van Noy*

**NORCAL CAR CARE**

Order Date 05/06/15 10:29 am

Paid: 05/06/15 11:26 am

Invoice No.

**000035755**

BAR #: RC221870  
EPA# CAL 000248793  
1666 PINER ROAD  
SANTA ROSA, CA 95403  
Phone: 707-568-5080 FAX: 707-579-3034

Cell Phone  
Work Phone:

88 CHEVROLET R20 SUBURBAN BL  
46683 Mi.  
Lic: 2JHY101/CA V8Cyl 7.4 Eng  
Vin: 1GNGR26N3JF131139  
Eq: AT AC PS FI

Quotes

1 05/06/15 10:38am 69.95  
BETTY in person.

**BIENNIAL SMOG INSPECTION 99 - Labor: \$61.70**

**BIENNIAL SMOG INSPECTION**

NOTICE: You may choose another smog check station to perform the needed repairs, installations, adjustments, or subsequent tests.

CAL	Smog Certificate-N	1.0 @	8.25 =\$	8.25	8.25
-----	--------------------	-------	----------	------	------

**Tire Inflation Service Declined Labor: \$0.00**

The customer declines the Tire Inflation service and affirms that  
a) the tire pressure services has been performed in the last 30 days .  
b) they will perform a tire pressure service within the next 7 days. \_\_\_\_\_.

Tire Inflation Service completed.  
Front: 70 psi Rear: 70 psi.

Payments to NORCAL CAR CARE	Cost Summary	
Status: Paid Work Order	Labor	61.70
	Parts	0.00
Payments: \$69.95	Non Taxable	8.25
1 05/06/15 69.95 Visa	Total	\$69.95
	Payments	69.95
	Bal Due	0.00

Thank you for choosing NORCAL CAR CARE

# Smog Check Vehicle Inspection Report (VIR)

## Vehicle Information

Test Date/Time: 05/06/2015 @ 10:46 AM

Model-Year: 1988	Make: CHEVROLET	Model: R20 SUBURBAN 2WD
License: 2JHY101	State: California	VIN: 1GNGR26N3JF131139
Engine Size: 7.40 L	Type: Truck	Transmission: Automatic
GVWR: 8600	Test Weight: 6000	Cylinders: 8
Odometer: 46683	Certification: California	VLT Record #: 01220
Fuel Type: Gasoline	Exhaust: Single	Inspection Reason: High Emitter Profile (HEP)

### Overall Test Results

Congratulations! Your vehicle passed the enhanced Smog Check inspection, which helps California reach its daily goal of removing an extra 100 tons of smog-forming emissions from the air. Thank you for keeping your vehicle well maintained.

Comprehensive Visual Inspection: **PASS**                      Functional Check: **PASS**                      Emissions Test: **PASS**

Smog Check Certificate Number: **PQ860374C**

DMV ID Number: **3215Q812P029**

Your Smog Check certificate will be electronically transmitted to DMV  
Please keep this copy for your records

### Emission Control Systems Visual Inspection/Functional Check Results

(Visual/Functional tests are used to assist in the identification of oxides of nitrogen, crankcase and cold start emission which are not measured during the ASM tests.)

<u>RESULT</u>	<u>ECS</u>	<u>RESULT</u>	<u>ECS</u>	<u>RESULT</u>	<u>ECS</u>
PASS-	PCV	PASS-	Thermostatic Air Cleaner	PASS-	Fuel Evaporative Controls
PASS-	Catalytic Converter	PASS-	Pump Air Injection	PASS-	Fuel Tank Cap Visual
PASS-	Visual EGR	PASS-	Ignition Spark Controls	N/A-	Carburetor
PASS-	Fuel Injection	PASS-	O2 Sensors and Connectors	PASS-	Wiring of Other
PASS-	Vacuum Line Connections	PASS-	Other Emission Related		Sensors or Switches
PASS-	Fuel Cap Functional	N/A-	Functional EGR	PASS-	Ignition Timing: 5 BTDC
PASS-	MIL	N/A-	Fill Pipe Restrictor	PASS-	Liquid Fuel Leaks
PASS-	Fuel Evap Test				

### ASM Emission Test Results

Test	RPM	CO2 (%)	O2 (%)	HC (PPM)			CO(%)			NO (PPM)			Results
		MEAS	MEAS	MAX	AVE	MEAS	MAX	AVE	MEAS	MAX	AVE	MEAS	
15 mph	1473	14.30	0.13	130	41	34	1.30	0.11	0.35	2200	1018	93	PASS
25 mph	1420	14.40	0.04	103	29	24	1.55	0.07	0.28	2150	928	35	PASS

MAX = Maximum Allowable Emissions

AVE = Average Emissions For Passing Vehicles

MEAS = Amount Measured

### Smog Check Inspection Station Information

NORCAL CAR CARE  
1662 PINER RD  
SANTA ROSA 95403  
707-586-1500

Technician Name/Number: MILES, WALTER/EO636089  
Repair Tech. Name/Number: N/A

Station Number: RC221870

Software Version/EIS Number: 1301/WP391812

I certify, under penalty of perjury under the laws of the State of California, that I inspected the vehicle described above, that I performed the inspection in accordance with all bureau requirements, and that the information listed on the vehicle inspection report is true and correct.

5-6-15

Date



Technician's Signature

**Certificates are valid for 90 days from date of issuance**

## LIMITED WARRANTY

This warranty is extended only to you, the original purchaser, and not to anyone who may purchase your automobile from you during the term of the warranty. This warranty is made by **NORCAL CAR CARE, INC** who performed the service/repairs on your vehicle.

### WHAT IS COVERED BY THE WARRANTY

A. Air Conditioning heating and climate control systems.	B. Clutches, clutch components, assembly repair or replacement.
C. Engine cooling system.	D. Starting and Charging system.
E. Engine performance, drivability services and repair.	F. Electrical system.
G. Emission control system.	H. Exhaust system.
I. Fuel system.	J. Ignition system.
K. Electronic engine management system and other on-board computer systems, (engine, body, brake and suspension computers), cruise control systems.	L. Steering/suspension systems, wheel bearings, CV joints/U joints, Half-shafts and drive shafts.
M. Brake system.	N. Other minor repairs.
<p>Dealer warrants that the above repairs and services performed at this location will be free from defects in materials and workmanship for twelve months or 12,000 miles of use, which ever comes first, measured from the date of the repair and the odometer reading shown on this repair order. This warranty is conditioned on the vehicle being subjected only to normal, <u>non-commercial</u> use and receiving reasonable and necessary maintenance during the warranty period. <b>Warranty repair costs are covered up to the cost of the original repair or service.</b> If there is a defect in either materials or workmanship within the warranty period, the Dealer shall have the option to either perform remedial service work at no charge to you, replace the defective warranted part(s) without charge to you, or refund to you the entire charge for the warranted repairs, minus any previous refunds.</p>	

### WHAT IS NOT COVERED BY THIS WARRANTY

You must pay for any non-warranty service you order to be performed at the same time as the warranty service. This warranty will not apply to your repaired vehicle if it has been damaged by abnormal use, misuse, neglect, accident, alteration, or "tampering with" (by other than the original Dealer or his employees). The Dealer's employees and/or agents do not have authority to modify the terms of this warranty or to make any promises in addition to those contained in this warranty. This warranty does not in any way include incidental or consequential damages (additional expenses which you may incur as the result of faulty repair or service).

### AUTOMOTIVE REPAIRS EXCLUDED FROM WARRANTY

This warranty does not cover repairs(s) or replacement(s) except as listed in the section "what is covered by this Warranty" even though **NORCAL CAR CARE, INC.** may offer other services. Specifically excluded are any repairs involving replacement or removal of internally lubricated parts and other such repairs as listed below. Automotive repairs excluded from the Warranty:

- I. ENGINE
  - a. Any internal repairs or replacement of internal components, or replacement of engine assembly.
- II. TRANSMISSION TRANSAXLES
  - a. Automatic-any internal repair or component replacement requiring the removal of the automatic transmission or trans-axle from the vehicle or dis-assembly of the same.
  - b. Manual-any internal repair or component replacement requiring the removal of the transmission or trans-axle from the vehicle or dis-assembly of the same.
- III. DRIVE AXLE-DIFFERENTIAL ASSEMBLY
  - a. Any repair or component replacement requiring the removal of internally lubricated components or replacement of the drive/axle differential assembly.
    - i. Ring gear, pinion shaft and related gears.
    - ii. Associated bearing with above.
    - iii. Pinion seal.
- IV. AUTOBODY, PAINT, MOLDING REPAIR
  - a. Any repair or materials related to auto body repair work.
  - b. Glass related repairs.
- V. COMMERCIAL VEHICLES

\* CODE N-NEW U-USED R-REBUILT M-OEM

QTY \* PART NO. OR DESCRIPTION SALE

1 2101299 AABA 705



1400 Farmer's Lane • Santa Rosa, CA 95405  
707 528-2713  
Brake & Lamp Station  
ARD 269 949



Date: 7-29-14  
Time Received

OPERATION LAB. CHG.

Name: J. Williams  
Address: [unclear]  
City: [unclear]

Vin. No: 16N06P236N03 JF1B1139  
Year-Make-Model: 1988 Chevy Blazer  
License No: 15TH101  
Odometer: 46,522

ESTIMATE AMT. [unclear]  
ADD'L AUTH. AMT. [unclear]  
REVISED ESTIMATE [unclear]

APPROVED BY: [unclear]  
DATE: [unclear]  
TIME: [unclear]

REPAIR ORDER LABOR INSTRUCTION  
INTERNAL

*Change Service  
Set time, resources  
Inspected the rear suspension/brake system  
for operation - found the bush in the tail end bad - new parts  
not available - 2.3 hr*

Additional Materials from reverse side  
TOTAL PARTS 205

BY LAW, YOU MAY CHOOSE ANOTHER LICENSED SMOG CHECK FACILITY TO PERFORM ANY NEEDED REPAIRS OR ADJUSTMENTS THAT THE SMOG CHECK TEST INDICATES ARE NECESSARY. A CUSTOMER WILL BE CHARGED FOR INSPECTION REGARDLESS OF PASS OR FAIL.

SPECIAL REPAIRS

QTY. SALE  
GALS. GAS 8 450  
QTS. OIL 10/30 450  
LBS. GREASE [unclear]  
TOTAL GAS OIL GREASE 3400  
RECOMMENDED SERVICE: [unclear]

BILLING:  CASH  CHARGE  INTERNAL  
OK'D BY: [unclear]

TEARDOWN ESTIMATE: I understand that my vehicle will be reassembled within [unclear] days of the date shown above if I choose not to authorize the services recommended.

TOTAL SPECIAL REPAIRS

Return Old Parts  Yes  No

TOTAL 9924

# VALLEY TIRE & BRAKE

1688 PINER ROAD, SANTA ROSA, CA 95403  
(707) 544-3420 • (800) 300-6696 • www.valleytire.com  
ENGINE MAINTENANCE (707) 521-2847

MICHELIN • BFGoodrich  
UNIROYAL • DUNLOP • Continental

EPA #CAL000072981  
BAR #AJ036777

Tires • Brakes • Alignment • Steering • Trailer Hitches  
Suspension • Struts • Shocks • Smog • Custom Wheels  
Tune Ups • Diagnostics • Problem Solving  
Mufflers & Exhaust Repair

Free Courtesy Cars • Since 1968

INVOICE #: 10137245

PAGE: 1

TIME STARTED: 15:04:25

TIME CLOSED: 16:19:02

CUSTOMER: 1  
1  
QUANTITY

HOME: 3 VEHICLE: 1988 CHEVROLET R20 SUBURBAN  
SALESMAN: ERIC OFFENBACHER LICENSE: 2JHY101 CA MILEAGE: 46300  
ENGINE: 7.4L V8 FI  
VIN: 1GNGR26N3JF131139  
Fleet ID 12/87 AT AC  
DUE: 04/30/13

INVOICE DATE: 04/30/13

PRODUCT	QUANTITY	PRICE	F.E.T.	EXTENSION
SMOG INSPECTION-AAA MEMBER SIA	1	77.75		77.75
SMOG CERTIFICATE SC	1	8.25		8.25
SET TIRE PRESSURES PER CA A.R.B. PSI	1			0.00
SET TIRE PRESSURES TO 44PSI FRONT / 51PSI REAR				

MERCHANDISE: 8.25  
LABOR: 77.75  
INVOICE TOTAL: 86.00  
VISA 86.00

TENDERED BY 2

ORIGINAL ESTIMATE OF REPAIRS: \$ \_\_\_\_\_ PLUS TAX  
Includes all parts, labor, handling and diagnosis. If on closer analysis it is found that additional repairs are necessary, you will be contacted for authorization pursuant to Division 3, Chapter 20.3, Article Sec. 9884.9 of the California Business and Professions Code. All parts are new unless specified otherwise. IF THE AUTOMOBILE IS RETURNED TO CUSTOMER BEFORE AUTHORIZED SERVICE IS PERFORMED, A DIAGNOSIS AND HANDLING CHARGE WILL BE MADE. Because of the extent of the tear down and inspection, the vehicle may not perform as well as before.

I have read and understand the above estimate and terms. I authorize service to be performed including sublet work, road test and acknowledge receipt of this estimate.

CUSTOMER SIGNATURE Betty Lamoy DATE \_\_\_\_\_ / \_\_\_\_\_ / \_\_\_\_\_

WARRANTY on parts and labor are 90 days or 4,000 miles, whichever comes first unless otherwise noted on invoice. Installed parts are not warranted beyond that given by manufacturer. All warranty items must be returned with invoice within warranty period for exchange or credit. Any warranty, parts or labor honored only at Valley Tire & Brake, Santa Rosa, California.

# SMOG CHECK VEHICLE INSPECTION REPORT

(04/30/2013 @ 4:03:16 pm)

## Vehicle Information

Model Year..... 1988	Make..... CHEVROLET	Model..... C20SUBURBAN
License..... 2JHY101	State..... California	VIN..... 1GNGR26N3JF131139
Engine Size..... 7.4 Liters	Type..... Truck	Transmission..... Automatic
GVWR..... 8600 lbs.	Test Weight..... 6000 lbs.	Cylinders..... 8
Odometer..... 46308	Certification..... California	VLT Record #..... 1220
Fuel Type..... Gasoline	Exhaust..... Single	Inspection Reason..... HEP
Engine Year..... N/A	Engine Make..... N/A	Bar Number..... N/A
Fleet BAR File #..... N/A		

## Overall Test Results

Congratulations! Your vehicle passed the enhanced Smog Check inspection, which helps California reach its daily goal of removing an extra 100 tons of smog-forming emissions from the air. Thank you for keeping your vehicle well maintained.

Visual Inspection..(Pass) Functional Check..(Pass) Emissions Test..(Pass)

DMV ID Number..(3808U1110199)  
Smog Check Certificate Number..(OU937318)

Your Smog Check certificate has been electronically transmitted to the DMV.  
This certificate is valid for ninety (90) days from the date of issuance.

Please keep this copy for your records.

## Emission Control Systems Visual Inspection/Functional Check Results

(Visual/Functional tests are used to assist the identification of oxides of nitrogen, crankcase, and cold start emissions which are not measured during the idle tests)

<u>ECS</u>	<u>Result</u>	<u>ECS</u>	<u>Result</u>	<u>ECS</u>	<u>Result</u>
PCV.....	Pass	Thermostatic Air Cleaner.....	Pass	Fuel Evaporative Controls.....	Pass
Catalytic Converter.....	Pass	EGR (Visual).....	Pass	Spark Controls.....	Pass
Fuel Injection.....	Pass	Pump Air Injection.....	Pass	Oxygen Sensor.....	Pass
Wiring to Sensors.....	Pass	Vacuum lines sensors/switches..	Pass	Other related emis. components.	Pass
Liquid Fuel Leak.....	Pass	Fuel Cap Integrity Test.....	Pass	Fuel Cap Visual.....	Pass
OBD System Check.....	Pass	Ignition Timing (06 BTDC).....	Pass	Fuel EVAP Test.....	Pass

## ASM Emission Test Results

Test	RPM		%CO2		HC (PPM)			CO (%)			NO (PPM)			Result
	MEAS	MEAS	MEAS	MEAS	MAX	AVE	MEAS	MAX	AVE	MEAS	MAX	AVE	MEAS	
M1: 15 MPH	1459	14.6	0.4	0.4	130	41	38	1.30	0.11	0.56	2200	1018	170	Pass
M2: 25 MPH	1400	14.5	0.4	0.4	103	29	77	1.55	0.07	0.76	2150	928	183	Pass

MAX = Maximum Allowed Emissions    AVE = Average Emissions For Passing Vehicles    MEAS = Amount Measured

## Smog Check Station Information

VALLEY TIRE AND BRAKE  
1688 PINER RD  
SANTA ROSA, CA 95403  
1 707 544 3420

Technician Name/Number..... MEDEIROS, ANTONIO/EA138015  
Repair Tech Name/Number..... N/A  
Software Version/EIS Number... 1201/SX100109  
Station Number..... RJ036777

I certify under penalty of perjury under the laws of the State of California, that I performed the inspection in accordance with all bureau requirements, and that the information listed on this vehicle inspection report is true and correct.

4/30/13

Date

Technician's Signature





**STRIKLY SMOG**  
 6598 Montecito Blvd. • Santa Rosa, CA 95409  
 Phone (707) 578-SMOG (7664)  
 ARD 00258071

M

**SMOG TEST-ONLY INVOICE**

NAME <i>B. D. L.</i>	TODAY'S DATE <i>6/2/11</i>	YEAR <i>88</i>	MAKE <i>Chrysler</i>	MODEL <i>Suburban</i>
ADDRESS <i>2100...</i>	ODOMETER <i>45872</i>	LIC. PLATE # <i>2JH4101</i>	MOTOR #	
CITY, STATE ZIP <i>Santa Rosa, CA 95401</i>	WRITTEN BY <i>[Signature]</i>	CUSTOMER P.O. #	G.V.W.R. <i>3600</i>	
PHONE / CUSTOMER EMAIL	TEST TYPE: <input checked="" type="checkbox"/> BIENNIAL <input type="checkbox"/> CHANGE OF OWNERSHIP <input type="checkbox"/> 2% <input type="checkbox"/> HEP <input type="checkbox"/> INITIAL			
METHOD OF PAYMENT: <input type="checkbox"/> CASH <input type="checkbox"/> CHECK <input type="checkbox"/> CHARGE <input type="checkbox"/> DEBIT CARD <input type="checkbox"/> CREDIT CARD	ENGINE <i>7.4L</i> # OF CYLINDERS			
ORIGINAL ESTIMATE \$ <i>3825</i>	TRANSMISSION: <input type="checkbox"/> AUTO <input type="checkbox"/> STD TIMING <i>4</i> EM. LIGHT			
V. I. N.				

**SMOG TEST CHECK OFF**

P-Pass M-Modified F-Defective D-Disconnected S-Missing N-N/A

PCV	<input checked="" type="checkbox"/>	C/I	<input checked="" type="checkbox"/>
TAC	<input checked="" type="checkbox"/>	AP/P	<input checked="" type="checkbox"/>
EVP	<input checked="" type="checkbox"/>	OXY	<input checked="" type="checkbox"/>
CAT	<input checked="" type="checkbox"/>	WRG	<input checked="" type="checkbox"/>
EGR	<input checked="" type="checkbox"/>	VAC	<input checked="" type="checkbox"/>
SPK	<input checked="" type="checkbox"/>	OTH	<input checked="" type="checkbox"/>

SMOKE INSPECTION: PCV  TAILPIPE

**TIRE PRESSURE INSPECTION**

Performed LF: RF: LR: RR: (psi) Initials

Inspection Declined, Reason:

OPR.	DESCRIPTION OF WORK	AMOUNT
	SMOG TEST	
	PRETEST <input type="checkbox"/> YES <input type="checkbox"/> NO	
	CERTIFICATE #	<i>825</i>
	ELECTRONIC TRANSFER FEE (E.T.F.)	
	RETEST	<i>30.00</i>
	GAS CAP	
	LOW PRESSURE FUEL EVAP TEST (LPFET)	

**SMOG TEST FEE IS DUE WHETHER ABOVE VEHICLE PASSES, FAILS OR ABORTS THE SMOG TEST.**

*BW* INITIAL

TEST RESULTS:  PASS  FAIL  ABORT

**THIS SMOG TEST-ONLY STATION CANNOT PERFORM ANY DIAGNOSTICS, ADJUSTMENTS OR REPAIRS**

I hereby authorize the above smog test to be performed. Smog test fee is due whether above vehicle passes or fails the smog test. You and your employees may operate above vehicle for purposes of testing, inspection and delivery at my risk. An express mechanic's lien is acknowledged on above vehicle to secure the amount of this invoice. You will not be held responsible for loss or damage to vehicle due to fire, theft, accident, dynamometer testing or any other cause beyond your control. In the event legal action is necessary to enforce this contract, I understand that I am solely responsible for all costs including attorney's fees and court costs. I have read and understand the above and acknowledge receipt of an estimate.

X *Betty VanNoy* DATE: *6/2/11*

REVISED ESTIMATE \$	DATE	TIME	PHONE • FAX • EMAIL	<input type="checkbox"/> PHONE <input type="checkbox"/> EMAIL <input type="checkbox"/> IN PERSON <input type="checkbox"/> FAX	I acknowledge notice and oral approval of an increase in the original estimated price.	TOTAL WORK	
REASON			ADDITIONAL COST \$	X		CERTIFICATE	
						E.T.F.	
						SUB TOTAL	
						SALES TAX	
						<b>GRAND TOTAL</b>	<i>3825</i>

# Smog Check Vehicle Inspection Report (VIR)

## Vehicle Information

Test Date/Time: 06/02/2011 @ 12:21 PM

Model-Year: 1988	Make: CHEVROLET	Model: C20SUBURBAN
License: 2JHY101	State: California	VIN: 1GNGR26N3JF131139
Engine Size: 7.40 L	Type: Truck	Transmission: Automatic
GVWR: 8600	Test Weight: 6000	Cylinders: 8
Odometer: 45872	Certification: California	VLT Record #: 01220
Fuel Type: Gasoline	Exhaust: Single	Inspection Reason: High Emitter Profile (HEP)

## Overall Test Results

Congratulations! Your vehicle passed the enhanced Smog Check inspection, which helps California reach its daily goal of removing an extra 100 tons of smog-forming emissions from the air. Thank you for keeping your vehicle well maintained.

Comprehensive Visual Inspection: PASS

Functional Check: PASS

Emissions Test: PASS

Smog Check Certificate Number: OE097868C

DMV ID Number: 3190E710O669

Your Smog Check certificate will be electronically transmitted to DMV  
Please keep this copy for your records

## Emission Control Systems Visual Inspection/Functional Check Results

(Visual/Functional tests are used to assist in the identification of oxides of nitrogen, crankcase and cold start emission which are not measured during the ASM tests.)

RESULT	ECS	RESULT	ECS	RESULT	ECS
PASS-	PCV	PASS-	Thermostatic Air Cleaner	PASS-	Fuel Evaporative Controls
PASS-	Catalytic Converter	PASS-	Pump Air Injection	PASS-	Fuel Tank Cap Visual
PASS-	Visual EGR	PASS-	Ignition Spark Controls	N/A-	Carburetor
PASS-	Fuel Injection	PASS-	O2 Sensors and Connectors	PASS-	Wiring of Other
PASS-	Vacuum Line Connections	PASS-	Other Emission Related		Sensors or Switches
PASS-	Fuel Cap Functional	N/A-	Functional EGR	PASS-	Ignition Timing: 4 BTDC
PASS-	MIL	N/A-	Fill Pipe Restrictor	PASS-	Liquid Fuel Leaks
PASS-	Fuel Evap Test				

## ASM Emission Test Results

Test	RPM	CO2 (%)		HC (PPM)			CO(%)			NO (PPM)			Results
		MEAS	MEAS	MAX	AVE	MEAS	MAX	AVE	MEAS	MAX	AVE	MEAS	
15 mph	1475	14.90	0.10	130	62	40	1.30	0.18	0.36	2200	437	109	PASS
25 mph	1455	14.99	0.04	103	45	34	1.55	0.12	0.28	2150	338	56	PASS

MAX = Maximum Allowable Emissions

AVE = Average Emissions For Passing Vehicles

MEAS = Amount Measured

## Smog Check Inspection Station Information

STRKLY SMOG  
6598 MONTECITO BLVD.  
SANTA ROSA 95409  
707-578-7664  
Station Number: TC258071

Technician Name/Number: PARKER, DAVID/EA107117  
Repair Tech. Name/Number: N/A

Software Version/EIS Number: 1008/WP391796

I certify, under penalty of perjury under the laws of the State of California, that I inspected the vehicle described above, that I performed the inspection in accordance with all bureau requirements, and that the information listed on the vehicle inspection report is true and correct.

6-2-11

Date

Technician's Signature

Certificates are valid for 90 days from date of issuance



# STRIKLY SMOG

6598 Montecito Blvd. • Santa Rosa, CA 95409  
Phone (707) 578-SMOG (7664)  
ARD 00258071

M

## SMOG TEST-ONLY INVOICE

NAME <i>B. J. ...</i>	TODAY'S DATE <i>6-2-11</i>	YEAR <i>88</i>	MAKE <i>Chrysler</i>	MODEL <i>Suburban</i>
ADDRESS <i>...</i>	ODOMETER	LIC. PLATE # <i>2JH4101</i>	MOTOR #	
CITY, STATE ZIP	WRITTEN BY <i>[Signature]</i>	CUSTOMER P.O. #	G.V.W.R.	
PHONE / CUSTOMER EMAIL	TEST TYPE: <input type="checkbox"/> BIENNIAL <input type="checkbox"/> CHANGE OF OWNERSHIP <input type="checkbox"/> 2% <input type="checkbox"/> HEP <input type="checkbox"/> INITIAL			
METHOD OF PAYMENT: <input type="checkbox"/> CASH <input type="checkbox"/> CHECK <input type="checkbox"/> CHARGE <input type="checkbox"/> DEBIT CARD <input type="checkbox"/> CREDIT CARD	ENGINE # OF CYLINDERS			
ORIGINAL ESTIMATE \$ <i>382</i>	TRANSMISSION: <input type="checkbox"/> AUTO <input type="checkbox"/> STD TIMING EM. LIGHT			
V. I. N.				

SMOG TEST CHECK OFF				
P-Pass	M-Modified	F-Defective	D-Disconnected	S-Missing N-N/A
<input type="checkbox"/>	<input type="checkbox"/>	<input type="checkbox"/>	<input type="checkbox"/>	<input type="checkbox"/>
PCV			C/I	
TAC			AP/P	
EVP			OXY	
CAT			WRG	
EGR			VAC	
SPK			OTH	

SMOKE INSPECTION: PCV TAILPIPE

TIRE PRESSURE INSPECTION

Performed LF: RF: LR: RR: (psi)

Inspection Declined, Reason: Initials:

**SMOG TEST FEE IS DUE WHETHER  
ABOVE VEHICLE PASSES, FAILS  
OR ABORTS THE SMOG TEST.**

*BW* INITIAL

OPR.	DESCRIPTION OF WORK	AMOUNT
	SMOG TEST	
	PRETEST <input type="checkbox"/> YES <input type="checkbox"/> NO	
	CERTIFICATE #	<i>825</i>
	ELECTRONIC TRANSFER FEE (E.T.F.)	
	RETEST	<i>30.00</i>
	GAS CAP	
	LOW PRESSURE FUEL EVAP TEST (LPFET)	

TEST RESULTS:  PASS  FAIL  ABORT

**THIS SMOG TEST-ONLY STATION CANNOT PERFORM ANY DIAGNOSTICS, ADJUSTMENTS OR REPAIRS**

I hereby authorize the above smog test to be performed. Smog test fee is due whether above vehicle passes or fails the smog test. You and your employees may operate above vehicle for purposes of testing, inspection and delivery at my risk. An express mechanic's lien is acknowledged on above vehicle to secure the amount of this invoice. You will not be held responsible for loss or damage to vehicle due to fire, theft, accident, dynamometer testing or any other cause beyond your control. In the event legal action is necessary to enforce this contract, I understand that I am solely responsible for all costs including attorney's fees and court costs. I have read and understand the above and acknowledge receipt of an estimate.

X *Betty Van Noy* DATE: *6-2-11*

REVISOR: \_\_\_\_\_ DATE: \_\_\_\_\_ TIME: \_\_\_\_\_ PHONE • FAX • EMAIL: \_\_\_\_\_

ESTIMATE \$ \_\_\_\_\_

REASON: \_\_\_\_\_

PHONE  EMAIL  IN-PERSON  FAX

I acknowledge notice and oral approval of an increase in the original estimated price.

ADDITIONAL COST \$ \_\_\_\_\_

TOTAL WORK	
CERTIFICATE	
E.T.F.	
SUB TOTAL	
SALES TAX	
<b>GRAND TOTAL:</b>	



**STRIKLY SMOG**  
 6598 Montecito Blvd. • Santa Rosa, CA 95409  
 Phone (707) 578-SMOG (7664)  
 ARD 00258071

M

**SMOG TEST-ONLY INVOICE**

NAME: <u>[Handwritten]</u>			TODAY'S DATE: <u>6.2.11</u>			YEAR: <u>88</u>		MAKE: <u>Chev</u>		MODEL: <u>Suburban 70</u>																																								
ADDRESS: <u>[Handwritten]</u>			ODOMETER: <u>45863</u>			LIC. PLATE #: <u>2JHY 101</u>		MOTOR.#:																																										
CITY, STATE ZIP: <u>[Handwritten]</u>			WRITTEN BY: <u>[Handwritten]</u>			CUSTOMER P.O. #:		G.V.W.R.: <u>8600</u>																																										
PHONE / CUSTOMER EMAIL: <u>[Handwritten]</u>			TEST TYPE: <input checked="" type="checkbox"/> BIENNIAL <input type="checkbox"/> CHANGE OF OWNERSHIP <input type="checkbox"/> 2% <input type="checkbox"/> HEP <input type="checkbox"/> INITIAL			ENGINE: <u>7.4L</u>		# OF CYLINDERS:																																										
METHOD OF PAYMENT: <input type="checkbox"/> CASH <input type="checkbox"/> CHECK <input type="checkbox"/> CHARGE <input type="checkbox"/> DEBIT CARD <input type="checkbox"/> CREDIT CARD			ORIGINAL ESTIMATE \$: <u>100</u>			TRANSMISSION: <input checked="" type="checkbox"/> AUTO <input type="checkbox"/> STD		TIMING: <u>40</u>		EM. LIGHT:																																								
SMOG TEST CHECK OFF			V.I.N.:							<u>1139</u>																																								
<table border="1"> <tr> <th>P-Pass</th> <th>M-Modified</th> <th>F-Defective</th> <th>D-Disconnected</th> <th>S-Missing</th> <th>N-N/A</th> </tr> <tr> <td><input checked="" type="checkbox"/></td> <td><input checked="" type="checkbox"/></td> <td><input checked="" type="checkbox"/></td> <td><input checked="" type="checkbox"/></td> <td><input checked="" type="checkbox"/></td> <td><input checked="" type="checkbox"/></td> </tr> </table>			P-Pass	M-Modified	F-Defective	D-Disconnected	S-Missing	N-N/A	<input checked="" type="checkbox"/>	<input checked="" type="checkbox"/>	<input checked="" type="checkbox"/>	<input checked="" type="checkbox"/>	<input checked="" type="checkbox"/>	<input checked="" type="checkbox"/>	<table border="1"> <tr> <th>OPR.</th> <th>DESCRIPTION OF WORK</th> <th>AMOUNT</th> </tr> <tr> <td></td> <td>SMOG TEST</td> <td><u>7175</u></td> </tr> <tr> <td></td> <td>PRETEST <input type="checkbox"/> YES <input checked="" type="checkbox"/> NO</td> <td></td> </tr> <tr> <td></td> <td>CERTIFICATE #</td> <td><u>825</u></td> </tr> <tr> <td></td> <td>ELECTRONIC TRANSFER FEE (E.T.F.)</td> <td></td> </tr> <tr> <td></td> <td>RETEST</td> <td></td> </tr> <tr> <td></td> <td>GAS CAP</td> <td></td> </tr> <tr> <td></td> <td>LOW PRESSURE FUEL EVAP TEST (LPFET)</td> <td></td> </tr> <tr> <td></td> <td><u>Passed</u></td> <td></td> </tr> <tr> <td></td> <td><u>AAA</u></td> <td><u>&lt;-1000&gt;</u></td> </tr> </table>			OPR.	DESCRIPTION OF WORK	AMOUNT		SMOG TEST	<u>7175</u>		PRETEST <input type="checkbox"/> YES <input checked="" type="checkbox"/> NO			CERTIFICATE #	<u>825</u>		ELECTRONIC TRANSFER FEE (E.T.F.)			RETEST			GAS CAP			LOW PRESSURE FUEL EVAP TEST (LPFET)			<u>Passed</u>			<u>AAA</u>	<u>&lt;-1000&gt;</u>	TIRE PRESSURE INSPECTION <input type="checkbox"/> Performed LF: RF: LR: RR: (psi) <input checked="" type="checkbox"/> Inspection Declined, Reason: Initials:		
P-Pass	M-Modified	F-Defective	D-Disconnected	S-Missing	N-N/A																																													
<input checked="" type="checkbox"/>	<input checked="" type="checkbox"/>	<input checked="" type="checkbox"/>	<input checked="" type="checkbox"/>	<input checked="" type="checkbox"/>	<input checked="" type="checkbox"/>																																													
OPR.	DESCRIPTION OF WORK	AMOUNT																																																
	SMOG TEST	<u>7175</u>																																																
	PRETEST <input type="checkbox"/> YES <input checked="" type="checkbox"/> NO																																																	
	CERTIFICATE #	<u>825</u>																																																
	ELECTRONIC TRANSFER FEE (E.T.F.)																																																	
	RETEST																																																	
	GAS CAP																																																	
	LOW PRESSURE FUEL EVAP TEST (LPFET)																																																	
	<u>Passed</u>																																																	
	<u>AAA</u>	<u>&lt;-1000&gt;</u>																																																
<p><b>SMOG TEST FEE IS DUE WHETHER ABOVE VEHICLE PASSES, FAILS OR ABORTS THE SMOG TEST.</b></p> <p><u>[Handwritten]</u> INITIAL</p>			TEST RESULTS: <input checked="" type="checkbox"/> PASS <input type="checkbox"/> FAIL <input type="checkbox"/> ABORT <input type="checkbox"/>																																															
<p>THIS SMOG TEST-ONLY STATION CANNOT PERFORM ANY DIAGNOSTICS, ADJUSTMENTS OR REPAIRS</p> <p>I hereby authorize the above smog test to be performed. Smog test fee is due whether above vehicle passes or fails the smog test. You and your employees may operate above vehicle for purposes of testing, inspection and delivery at my risk. An express mechanic's lien is acknowledged on above vehicle to secure the amount of this invoice. You will not be held responsible for loss or damage to vehicle due to fire, theft, accident, dynamometer testing or any other cause beyond your control. In the event legal action is necessary to enforce this contract, I understand that I am solely responsible for all costs including attorney's fees and court costs. I have read and understand the above and acknowledge receipt of an estimate.</p>			X <u>[Handwritten Signature]</u> DATE: <u>6.2.11</u>			TOTAL WORK																																												
REVISED ESTIMATE \$ REASON:			<input type="checkbox"/> PHONE <input type="checkbox"/> EMAIL <input type="checkbox"/> IN PERSON <input type="checkbox"/> FAX ADDITIONAL COST \$			CERTIFICATE																																												
I acknowledge notice and oral approval of an increase in the original estimated price.			<input checked="" type="checkbox"/>			E.T.F.																																												
						SUB TOTAL																																												
						SALES TAX																																												
						GRAND TOTAL				<u>6175</u>																																								

# Smog Check Vehicle Inspection Report (VIR)

## Vehicle Information

Test Date/Time: 06/02/2011 @ 11:17 AM

Model-Year: 1988	Make: CHEVROLET	Model: C20SUBURBAN
License: 2JHY101	State: California	VIN: 1GNGR26N3JF131139
Engine Size: 7.40 L	Type: Truck	Transmission: Automatic
GVWR: 8600	Test Weight: 6000	Cylinders: 8
Odometer: 45863	Certification: California	VLT Record #: 01220
Fuel Type: Gasoline	Exhaust: Single	Inspection Reason: High Emitter Profile (HEP)

### Overall Test Results

Repairing your vehicle is necessary to help California reduce smog-forming emissions and reach our air quality goals.

Comprehensive Visual Inspection: **TAMPERED**      Functional Check: **PASS**      Emissions Test: **PASS**

### Emission Control Systems Visual Inspection/Functional Check Results

(Visual/Functional tests are used to assist in the identification of oxides of nitrogen, crankcase and cold start emission which are not measured during the ASM tests.)

<u>RESULT</u>	<u>ECS</u>	<u>RESULT</u>	<u>ECS</u>	<u>RESULT</u>	<u>ECS</u>
PASS-	PCV	PASS-	Thermostatic Air Cleaner	<b>FAIL-</b>	Fuel Evaporative Controls
PASS-	Catalytic Converter	PASS-	Pump Air Injection	PASS-	Fuel Tank Cap Visual
PASS-	Visual EGR	PASS-	Ignition Spark Controls	N/A-	Carburetor
PASS-	Fuel Injection	PASS-	O2 Sensors and Connectors	PASS-	Wiring of Other
<b>DISCONNECTED-</b>	Vacuum Line Connections	PASS-	Other Emission Related		Sensors or Switches
PASS-	Fuel Cap Functional	N/A-	Functional EGR	PASS-	Ignition Timing: 4 BTDC
PASS-	MIL	N/A-	Fill Pipe Restrictor	PASS-	Liquid Fuel Leaks
PASS-	Fuel Evap Test				

### ASM Emission Test Results

Test	RPM	CO2 (%)		HC (PPM)			CO(%)			NO (PPM)			Results
		MEAS	MEAS	MAX	AVE	MEAS	MAX	AVE	MEAS	MAX	AVE	MEAS	
15 mph	1469	14.75	0.18	130	62	50	1.30	0.18	0.46	2200	437	122	PASS
25 mph	1467	14.85	0.08	103	45	43	1.55	0.12	0.44	2150	338	64	PASS

MAX = Maximum Allowable Emissions

AVE = Average Emissions For Passing Vehicles

MEAS = Amount Measured

Failed smog check? Financial assistance may be available. To get an application, visit the Bureau of Automotive Repair's website at [www.smogcheck.ca.gov](http://www.smogcheck.ca.gov) or call toll-free at 800.952.5210. Si usted ha fallado el examen de smog, asistencia financiera puede estar disponible. Para obtener una solicitud, visite [www.smogcheck.ca.gov](http://www.smogcheck.ca.gov) o llamenos a BAR al 800.952.5210.

### Smog Check Inspection Station Information

STRKLY SMOG  
6598 MONTECITO BLVD.  
SANTA ROSA 95409  
707-578-7664  
Station Number: TC258071

Technician Name/Number: PARKER, DAVID/EA107117  
Repair Tech. Name/Number: N/A

Software Version/EIS Number: 1008/WP391796

I certify, under penalty of perjury under the laws of the State of California, that I inspected the vehicle described above, that I performed the inspection in accordance with all bureau requirements, and that the information listed on the vehicle inspection report is true and correct.

6-2-11  
Date

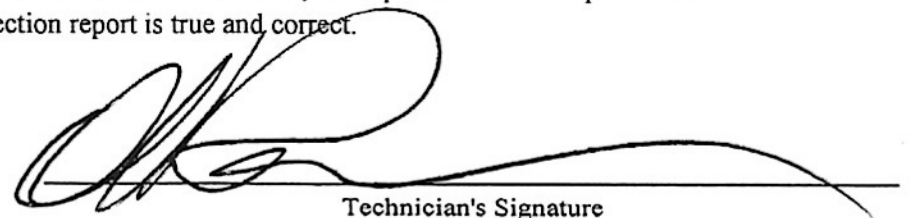
  
Technician's Signature

# Smog Check Vehicle Inspection Report (VIR)

## Vehicle Information

Test Date/Time: 05/14/2009 @ 12:15 PM

Model-Year: 1988	Make: CHEVROLET	Model: K20 SUBURBAN
License: 2JHY101	State: California	VIN: 1GNGR26N3JF131139
Engine Size: 7.40 L	Type: Truck	Transmission: Automatic
GVWR: 7200	Test Weight: 5250	Cylinders: 8
Odometer: 44862	Certification: California	VLT Record #: 40615
Fuel Type: Gasoline	Exhaust: Single	Inspection Reason: High Emitter Profile (HEP)

### Overall Test Results

Congratulations! Your vehicle passed the enhanced Smog Check inspection, which helps California reach its daily goal of removing an extra 100 tons of smog-forming emissions from the air. Thank you for keeping your vehicle well maintained.

Comprehensive Visual Inspection: **PASS**                      Functional Check: **PASS**                      Emissions Test: **PASS**

Smog Check Certificate Number: **NK265090C**

DMV ID Number: **3899K713N169**

Your Smog Check certificate will be electronically transmitted to DMV  
Please keep this copy for your records

### Emission Control Systems Visual Inspection/Functional Check Results

(Visual/Functional tests are used to assist in the identification of oxides of nitrogen, crankcase and cold start emission which are not measured during the ASM tests.)

<u>RESULT</u>	<u>ECS</u>	<u>RESULT</u>	<u>ECS</u>	<u>RESULT</u>	<u>ECS</u>
PASS-	PCV	PASS-	Thermostatic Air Cleaner	PASS-	Fuel Evaporative Controls
PASS-	Catalytic Converter	PASS-	Pump Air Injection	PASS-	Fuel Tank Cap Visual
PASS-	Visual EGR	PASS-	Ignition Spark Controls	N/A-	Carburetor
PASS-	Fuel Injection	PASS-	O2 Sensors and Connectors	PASS-	Wiring of Other
PASS-	Vacuum Line Connections	PASS-	Other Emission Related		Sensors or Switches
PASS-	Fuel Cap Functional	N/A-	Functional EGR	PASS-	Ignition Timing: 5 BTDC
PASS-	MIL	N/A-	Fill Pipe Restrictor	PASS-	Liquid Fuel Leaks
PASS-	Fuel Evap Test				

### ASM Emission Test Results

Test	RPM	CO2 (%)		HC (PPM)			CO(%)			NO (PPM)			Results
		MEAS	MEAS	MAX	AVE	MEAS	MAX	AVE	MEAS	MAX	AVE	MEAS	
15 mph	1405	14.90	0.09	112	51	33	0.60	0.12	0.29	975	301	85	PASS
25 mph	1395	15.01	0.04	92	37	25	0.79	0.09	0.19	835	241	27	PASS

MAX = Maximum Allowable Emissions

AVE = Average Emissions For Passing Vehicles

MEAS = Amount Measured

### Smog Check Inspection Station Information

STRICTLY SMOG INC.  
6598 MONTECITO BLVD.  
SANTA ROSA 95409  
707-578-7664

Technician Name/Number: MADISON, PATRICK/EA114517  
Repair Tech. Name/Number: N/A  
Software Version/EIS Number: 703/WP391796

Station Number: TG240517

I certify, under penalty of perjury under the laws of the State of California, that I inspected the vehicle described above, that I performed the inspection in accordance with all bureau requirements, and that the information listed on the vehicle inspection report is true and correct.

5-14-09

Date

\_\_\_\_\_  
Technician's Signature

**Certificates are valid for 90 days from date of issuance**



# STRIKLY SMOG

6598 Montecito Blvd. • Santa Rosa, CA 95409

Phone (707) 578-SMOG (7664)

M

## SMOG TEST-ONLY INVOICE

NAME <i>Betty Ann Voy</i>	TODAY'S DATE <i>5-14-09</i>	YEAR <i>88</i>	MAKE <i>Chev</i>	MODEL <i>Delta</i>
ADDRESS <i>Victoria St</i>	ODOMETER <i>44862</i>	LIC. PLATE # <i>2JH4101</i>	MOTOR #	
CITY, STATE ZIP <i>Santa Rosa, CA 95404</i>	WRITTEN BY	CUSTOMER P.O. #	G.V.W.R.	
HOME PHONE ( ) ( )	<input type="checkbox"/> WORK <input checked="" type="checkbox"/> CELL <input type="checkbox"/> PAGER	TEST TYPE: <input type="checkbox"/> BIENNIAL <input type="checkbox"/> CHANGE OF OWNERSHIP <input type="checkbox"/> 2% <input type="checkbox"/> HEP <input type="checkbox"/> INITIAL	<input type="checkbox"/> FED. <input type="checkbox"/> CALIF. <input type="checkbox"/> O/S	ENGINE _____ # OF CYLINDERS _____
METHOD OF PAYMENT: <input type="checkbox"/> CASH <input checked="" type="checkbox"/> CHECK	ORIGINAL ESTIMATE	TRANSMISSION: <input type="checkbox"/> AUTO <input type="checkbox"/> STD	TIMING	EM. LIGHT
<input type="checkbox"/> CHARGE <input type="checkbox"/> DEBIT CARD <input type="checkbox"/> CREDIT CARD	\$ <i>70.00</i>	V. I. N.		

### SMOG TEST CHECK OFF

P-Pass	M-Modified	F-Defective	D-Disconnected	S-Missing	N-N/A
PCV			C/I		
TAC			AP/P		
EVP			OXY		
CAT			WRG		
EGR			VAC		
SPK			OTH		

SMOKE INSPECTION. PCV: \_\_\_\_\_ TAILPIPE: \_\_\_\_\_

**SMOG TEST FEE IS DUE WHETHER ABOVE VEHICLE PASSES, FAILS OR ABORTS THE SMOG TEST.**

*BA* INITIAL

OPR.	DESCRIPTION OF WORK	AMOUNT
	SMOG TEST	<i>71.75</i>
	PRETEST <input type="checkbox"/> YES <input type="checkbox"/> NO	
	CERTIFICATE #	<i>825</i>
	ELECTRONIC TRANSFER FEE (E.T.F.)	
	RETEST	
	GAS CAP	
	LOW PRESSURE FUEL EVAP TEST (LPFET)	
	<i>AAA-</i>	<i>-10.00</i>

TEST RESULTS:  PASS  FAIL  ABORT

### THIS SMOG TEST-ONLY STATION CANNOT PERFORM ANY DIAGNOSTICS, ADJUSTMENTS OR REPAIRS

I hereby authorize the above smog test to be performed. Smog test fee is due whether above vehicle passes or fails the smog test. You and your employees may operate above vehicle for purposes of testing, inspection and delivery at my risk. An express mechanic's lien is acknowledged on above vehicle to secure the amount of this invoice. You will not be held responsible for loss or damage to vehicle due to fire, theft, accident, dynamometer testing or any other cause beyond your control. In the event legal action is necessary to enforce this contract, I understand that I am solely responsible for all costs including attorney's fees and court costs. I have read and understand the above and acknowledge receipt of an estimate.

X *Betty Ann Voy*

DATE: *5-14-09*

REVISED ESTIMATE \$	DATE	TIME	PHONE • FAX • EMAIL	<input type="checkbox"/> PHONE <input type="checkbox"/> EMAIL	I acknowledge notice and oral approval of an increase in the original estimated price.
REASON				<input type="checkbox"/> IN PERSON <input type="checkbox"/> FAX	
			ADDITIONAL COST \$		X

TOTAL WORK		
CERTIFICATE		
E.T.F.		
SUB TOTAL		
SALES TAX		
<b>GRAND TOTAL</b>	<i>70.00</i>	



Phone (707) 578-SMOG (7664)

# SMOG TEST-ONLY INVOICE

VEHICLE MAKE	YEAR	MODEL
ADDRESS	ODOMETER	LIC. PLATE #
CITY, STATE ZIP	WRITTEN BY	CUSTOMER P.O. #
HOME PHONE	TEST TYPE: <input type="checkbox"/> BIENNIAL <input type="checkbox"/> CHANGE OF OWNERSHIP <input type="checkbox"/> 2% <input type="checkbox"/> HEP <input type="checkbox"/> INITIAL	
METHOD OF PAYMENT: <input type="checkbox"/> CASH <input checked="" type="checkbox"/> CHECK <input type="checkbox"/> CHARGE <input type="checkbox"/> DEBIT CARD <input type="checkbox"/> CREDIT CARD	ORIGINAL ESTIMATE \$ 70.00	ENGINE # OF CYLINDERS
V. I. N.		TRANSMISSION: <input type="checkbox"/> AUTO <input type="checkbox"/> STD TIMING EM. LIGHT

SMOG TEST CHECK OFF			
P	M	F	D
Pass	Modified	Defective	Disconnected

OPR.	DESCRIPTION OF WORK	AMOUNT
	SMOG TEST	71.75
	PRETEST <input type="checkbox"/> YES <input type="checkbox"/> NO	
	CERTIFICATE #	825
	ELECTRONIC TRANSFER FEE (E.T.F.)	
	RETEST	
	GAS CAP	
	LOW PRESSURE FUEL EVAP TEST (LPFET)	
	AAA-	-10.00

**SMOG TEST FEE IS DUE WHETHER ABOVE VEHICLE PASSES, FAILS OR ABORTS THE SMOG TEST.**

*BJ* INITIAL

TEST RESULTS:  PASS  FAIL  ABORT

**THIS SMOG TEST-ONLY STATION CANNOT PERFORM ANY DIAGNOSTICS, ADJUSTMENTS OR REPAIRS**

I hereby authorize the above smog test to be performed. Smog test fee is due whether above vehicle passes or fails the smog test. You and your employees operate above vehicle for purposes of testing, inspection and delivery at my risk. An express mechanic's lien is acknowledged on above vehicle to secure the amount of this invoice. You will not be held responsible for loss or damage to vehicle due to fire, theft, accident, dynamometer testing or any other use beyond your control. In the event legal action is necessary to enforce this contract, I understand that I am solely responsible for all costs including attorney's fees and court costs. I have read and understand the above and acknowledge receipt of an estimate.

*Betty Van Nooy* DATE: 5-14-09

ADDITIONAL COST \$ X

TOTAL WORK	
CERTIFICATE	
E.T.F.	
SUB TOTAL	
SALES TAX	
<b>GRAND TOTAL</b>	



# Smog Check Vehicle Inspection Report (VIR)

## Vehicle Information

Test Date/Time: 05/14/2009 @ 12:15 PM

Model-Year: 1988	Make: CHEVROLET	Model: K20 SUBURBAN
License: 2JHY101	State: California	VIN: 1GNGR26N3JF131139
Engine Size: 7.40 L	Type: Truck	Transmission: Automatic
GVWR: 7200	Test Weight: 5250	Cylinders: 8
Odometer: 44862	Certification: California	VLT Record #: 40615
Fuel Type: Gasoline	Exhaust: Single	Inspection Reason: High Emitter Profile (HEP)

### Overall Test Results

Congratulations! Your vehicle passed the enhanced Smog Check inspection, which helps California reach its daily goal of removing an extra 100 tons of smog-forming emissions from the air. Thank you for keeping your vehicle well maintained.

Comprehensive Visual Inspection: **PASS**                      Functional Check: **PASS**                      Emissions Test: **PASS**

Smog Check Certificate Number: **NK265090C**

DMV ID Number: **3899K713N169**

Your Smog Check certificate will be electronically transmitted to DMV  
Please keep this copy for your records

### Emission Control Systems Visual Inspection/Functional Check Results

(Visual/Functional tests are used to assist in the identification of oxides of nitrogen, crankcase and cold start emission which are not measured during the ASM tests.)

<u>RESULT</u>	<u>ECS</u>	<u>RESULT</u>	<u>ECS</u>	<u>RESULT</u>	<u>ECS</u>
PASS-	PCV	PASS-	Thermostatic Air Cleaner	PASS-	Fuel Evaporative Controls
PASS-	Catalytic Converter	PASS-	Pump Air Injection	PASS-	Fuel Tank Cap Visual
PASS-	Visual EGR	PASS-	Ignition Spark Controls	N/A-	Carburetor
PASS-	Fuel Injection	PASS-	O2 Sensors and Connectors	PASS-	Wiring of Other
PASS-	Vacuum Line Connections	PASS-	Other Emission Related		Sensors or Switches
PASS-	Fuel Cap Functional	N/A-	Functional EGR	PASS-	Ignition Timing: 5 BTDC
PASS-	MIL	N/A-	Fill Pipe Restrictor	PASS-	Liquid Fuel Leaks
PASS-	Fuel Evap Test				

### ASM Emission Test Results

Test	RPM	CO2	O2	HC (PPM)			CO(%)			NO (PPM)			Results
		(%)	(%)	MAX	AVE	MEAS	MAX	AVE	MEAS	MAX	AVE	MEAS	
15 mph	1405	14.90	0.09	112	51	33	0.60	0.12	0.29	975	301	85	PASS
25 mph	1395	15.01	0.04	92	37	25	0.79	0.09	0.19	835	241	27	PASS

MAX = Maximum Allowable Emissions

AVE = Average Emissions For Passing Vehicles

MEAS = Amount Measured

### Smog Check Inspection Station Information

STRICTLY SMOG INC.  
6598 MONTECITO BLVD.  
SANTA ROSA 95409  
707-578-7664  
Station Number: TG240517

Technician Name/Number: MADISON, PATRICK/EA114517  
Repair Tech. Name/Number: N/A  
Software Version/EIS Number: 703/WP391796

I certify, under penalty of perjury under the laws of the State of California, that I inspected the vehicle described above, that I performed the inspection in accordance with all bureau requirements, and that the information listed on the vehicle inspection report is true and correct.

5-14-09

Date

Technician's Signature

Certificates are valid for 90 days from date of issuance

\* CODE N=New U=Used R=Rebuilt M=OEM

PART NO. OR DESCRIPTION SALE

1 Set MX 52 H.V. 24.85

1 Wagon Brake Pads 35.75

1 H36954 Hex 35.75

1 H38563 Hex 35.75

2 Brake Fluid 6.00

PAID  
Jul 29 2008  
JUL # 1343

**Wiseman's Valero Service**  
1400 Farmer's Lane • (707) 528-2713  
SANTA ROSA, CA 95405  
Brake & Lamp Station  
EPA. No. CAL 000 038 523  
B.A.R.No. AE-18794



Date 7-28-08  
Time Received  
A.M. P.M.  
OPERATION LABOR CHARGE  
Lubrication  
Change Oil  
Change Oil Filter Cart.  
Service Air Cleaner  
Change Trans. Oil  
Adjust Transmission  
Hazardous Waste  
Pack Front Wheel Brgs.  
Rotate Tires  
Adjust Brakes  
Retain Parts  
Destroy Parts

Name  
Address  
City  
State  
Zip  
Phone when ready  
Yes  No   
Bus.  
Cust. Order No.  
Written By  
A.M. P.M.

Year/Make-Model  
88 Chev. 20 Sub.  
License No.  
2JHY101  
Odometer  
9  
Phone when ready  
Yes  No   
Bus.  
Cust. Order No.  
Written By  
A.M. P.M.

ESTIMATE AMT.  
ADD'L AUTH. AMT.  
REVISED ESTIMATE  
APPROVED BY  
 IN PERSON  PHONE  
Date:  
Time:  
OPER. NO.

REPAIR ORDER LABOR INSTRUCTION  
I hereby authorize the repair work below to be done along with the necessary material, and hereby grant your and/or your employees permission to operate the car, truck or vehicle herein described on streets, highways or elsewhere for the purpose of testing and/or inspection. An express mechanic's lien is hereby acknowledged on above car, truck or vehicle to secure the amount of repairs thereto. You will not be held responsible for loss or damage to vehicle or articles left in vehicle in case of fire, theft, accident or any other cause beyond your control.  
Authorized By  
I ACKNOWLEDGE NOTICE AND ORAL APPROVAL OF AN INCREASE IN THE ORIGINAL ESTIMATED PRICE  
(SIGNATURE OR INITIALS)

Check Front 2 Rear Brakes  
Rear 40% to Left - Needs Fronts  
Rear Front Coilover Asstors  
Install New H.D. Washers Brake Pads  
Install New Left and Right Front  
Brake Hoses  
Rear Hyr Brake System  
Kobor 2.0

QTY	SALE	BILLING	TEARDOWN ESTIMATE - PARTS AND LABOR	ORIGINAL ESTIMATES	AUTHORIZED BY	DATE	TIME	REASON	Total Labor	Hazardous Waste Disposal	Special Repairs	Parts	Tires	Gas, Oil & Grease	Paint & Body Shop	Sales Tax	TOTAL	
		<input type="checkbox"/> CASH <input type="checkbox"/> CHARGE <input type="checkbox"/> INTERNAL OK'D BY							180.00			152.41					344.61	
TOTAL GAS OIL GREASE																		
RECOMMENDED SERVICE:																		
ADDITIONAL COSTS																		
TEARDOWN ESTIMATE: I understand that my vehicle will be reassembled within _____ days of the date shown above if I choose not to authorize the services recommended.																		
RETURN Old Parts? <input type="checkbox"/> Yes <input type="checkbox"/> No																		

BY LAW, YOU MAY CHOOSE ANOTHER LICENSED SMOG CHECK FACILITY TO PERFORM ANY NEEDED REPAIRS OR ADJUSTMENTS THAT THE SMOG CHECK TEST INDICATES ARE NECESSARY. A CUSTOMER WILL BE CHARGED FOR INSPECTION REGARDLESS OF PASS OR FAIL.

SPECIAL REPAIRS

QTY	SALE	BILLING	TEARDOWN ESTIMATE - PARTS AND LABOR	ORIGINAL ESTIMATES	AUTHORIZED BY	DATE	TIME	REASON	Total Labor	Hazardous Waste Disposal	Special Repairs	Parts	Tires	Gas, Oil & Grease	Paint & Body Shop	Sales Tax	TOTAL
		<input type="checkbox"/> CASH <input type="checkbox"/> CHARGE <input type="checkbox"/> INTERNAL OK'D BY							180.00			152.41					344.61
TOTAL GAS OIL GREASE																	
RECOMMENDED SERVICE:																	
ADDITIONAL COSTS																	
TEARDOWN ESTIMATE: I understand that my vehicle will be reassembled within _____ days of the date shown above if I choose not to authorize the services recommended.																	
RETURN Old Parts? <input type="checkbox"/> Yes <input type="checkbox"/> No																	

\* CODE N=New U=Used R=Rebuilt M=OEM

QTY	* CODE	N=New	U=Used	R=Rebuilt	M=OEM	SALE
1	39324	New				87.76
	Brake Master Cyl.					
2	Brake Fluid					61.50

**Wiseman's Valero Service**  
 1400 Farmer's Lane • (707) 528-2713  
 SANTA ROSA, CA 95405  
 Brake & Lamp Station  
 EPA. No. CAL 000 038 523  
 B.A.R. No. AE-18794



Date **7-18-08**  
 Time Received  
 A.M. P.M.  
 Promised  
 A.M. P.M.  
 Written By  
 Cust. Order No.  
 Phone when ready  
 P Yes  No   
 HI Res.  No   
 O Res.  No

OPERATION LABOR CHARGE  
 Lubrication  
 Change Oil  
 Change Oil Filter Cart.  
 Service Air Cleaner  
 Change Oil Trans. Oil  
 Adjust Transmission  
 Hazardous Waste  
 Pack Front Wheel Brigs.  
 Rotate Tires  
 Adjust Brakes  
 Retain Parts  
 Destroy Parts

Name: \_\_\_\_\_ City: \_\_\_\_\_  
 Address: \_\_\_\_\_  
 Vin No. \_\_\_\_\_  
 Year-Make-Model: **88 Sub. 20 514** License No. **2NH Y 101** Odometer: **611**  
 ESTIMATE AMT. \_\_\_\_\_  
 ADD'L AUTH. AMT. \_\_\_\_\_  
 REVISED ESTIMATE \_\_\_\_\_  
 Date: \_\_\_\_\_  
 APPROVED BY  IN PERSON  PHONE  
 I hereby authorize the repair work below to be done along with the necessary material, and hereby grant your and/or your employees permission to operate the car, truck or vehicle herein described on streets, highways or elsewhere for the purpose of testing and/or inspection. An express mechanic's lien is hereby acknowledged on above car, truck or vehicle to secure the amount of repairs thereto. You will not be held responsible for loss or damage to vehicle or articles left in vehicle in case of fire, theft, accident or any other cause beyond your control.  
 Authorized By: \_\_\_\_\_  
 I ACKNOWLEDGE NOTICE AND ORAL APPROVAL OF AN INCREASE IN THE ORIGINAL ESTIMATED PRICE (SIGNATURE OR INITIALS)  
 REPAIR ORDER LABOR INSTRUCTION: \_\_\_\_\_  
 INTERNAL

**Ins. Bill New Brake Master cyl.**  
**Bleed Hyd Brake System**  
**ROAR TEST**  
**Water .80**

QTY	SALE	BILLING	TEARDOWN ESTIMATE - PARTS AND LABOR	REASON	Total Labor
1		<input type="checkbox"/> CASH <input type="checkbox"/> CHARGE <input type="checkbox"/> INTERNAL OK'D BY	ORIGINAL ESTIMATES PHONE DATE TIME	AUTHORIZED BY DATE TIME	22.00
2			REVISED ESTIMATES		22.00
TOTAL PARTS					93.76
Additional Materials from reverse side					
TOTAL SPECIAL PAIRS					7.50
TOTAL					173.26

BY LAW, YOU MAY CHOOSE ANOTHER LICENSED SMOG CHECK FACILITY TO PERFORM ANY NEEDED REPAIRS OR ADJUSTMENTS THAT THE SMOG CHECK TEST INDICATES ARE NECESSARY. A CUSTOMER WILL BE CHARGED FOR INSPECTION REGARDLESS OF PASS OR FAIL.

RECOMMENDED SERVICE:  
 1. Repolish the front brakes  
 2. Base for new keys  
 3. Keys for more information

TEARDOWN ESTIMATE: I understand that my vehicle will be reassembled within \_\_\_\_\_ days of the date shown above if I choose not to authorize the services recommended.  
 Return Old Parts?  Yes  No



45 front 60 back

MEMBER PURCHASE INVOICE

INVOICE# 000410092038

DATE 1/29/2008

12:34:11

NAME \_\_\_\_\_ PHONE \_\_\_\_\_ 0 ALT PHONE \_\_\_\_\_

MEMBERSHIP# 803414976000

ADDRESS \_\_\_\_\_ CITY S. \_\_\_\_\_ ST CA ZIP \_\_\_\_\_

YEAR 1988 MAKE CHEVY TRUCKS MODEL C20 Chevy SUB-MODEL 4x2

GVW \_\_\_\_\_ WHEEL BASE \_\_\_\_\_ ODOMETER 44241 COLOR BLUE LIC# 2JHY101

AIR FRONT 44 REAR 80 TORQUE 120 ALLOY \_\_\_\_\_ STEEL X \_\_\_\_\_ SALESPERSON \_\_\_\_\_

QTY	DESCRIPTION	SLIP PRINT
	ITEM# MANUF TYPE SIZE	
	ITEM# MANUF TYPE SIZE	
	6850 Car, Light Truck, Van, SUV Installation Package: Mount, Balance Rubber Valve Stem, Rotations, Rebalances, Repairs, Air Checks	
	7023 Costco Scrap Tire Disposal Fee Charged on all tires left for disposal. State disposal fees may also apply.	
	6841 Seasonal Exchange	
	8399 Snow Tire Studding Fee	
	6861 Rebalance (Non-Costco Tire)	
DOT 1	RF Flat Repair	N/C
DOT 2	2 Rotation	N/C
DOT 3	4 Rebalance	N/C
DOT 4	Road Hazard Warranty	
DOT 5	Mileage Adjustment	
DOT 6	Manuf. Defect	
DOT 7	Member Services	
DOT 8		

WORK TO BE DONE

SERVICE NOTES

L/F       R/F  
 L/R       R/R  
 S

Best to Spare  
 Static     Dynamic  
 Blackwall     Whitewall

• Air Pressure and Torque are levels recommended by Manufacturer.

1-25-08

Santa Rosa 

1013493

226402

CHEVROLET ISUZU

\*INVOICE\*

2770 CORBY AVENUE \* SANTA ROSA, CA 95407

(707) 544-1234

SANTA ROSA. CA 95409-4054  
HOME: 707 70 BUS:  
CELL: 707 39

PAGE 1

www.santarosachevrolet.com

SERVICE ADVISOR: 463 JASON TOSTADO

BAR # AC 108903

EPA# CAD 981571615

COLOR	YEAR	MAKE/MODEL	VIN	LICENSE	MILEAGE IN/ OUT	TAG
WHITE	88	CHEVROLET SUBURBAN	1GNGR26N3JF131139	2JHY101	44134/44136	T2413
IN SVC. DATE	PROD. DATE	PROMISED	PO NO.	PAYMENT	INV. DATE	
01JAN88 IS		17:00 21JAN08		0.00 CASH	25JAN08	
R.O. OPENED	DATE CLOSED	OPTIONS: ENG:7.4_Liter_FI_CPC				
07:32 21JAN08	16:15 25JAN08					

LINE	OPCODE	TECH	LIST	NET	TOTAL
A		CUSTOMER STATES THAT THE SERVICE ENGINE SOON LIGHT IS ON. AFTER 5 MINUTES THE VEHICLE RUNS ROUGH AND WANTS TO QUIT. INSPECT AND ADVISE. L100.			
		110 GAS ENGINE			
		486 WHITE, BARRETT LIC#: 486			
		CCT		360.00	360.00
		1 10108445 GASKET	1.19	1.19	1.19
		1 1103952 DISTRIBUT	244.29	219.95	219.95
PARTS:	221.14	LABOR:	360.00	OTHER:	0.00
				TOTAL LINE A:	581.14

44136 INSPECTED FOR ROUGH RUN AND SERVICE LAMP FOUND CODE 45 RICH VEHICLE RUNS VERY POOR SECONDARY IGNITION IS FAILING PLUG WIRES ARE 20 YEARS OLD AND RUSTY REMOVED DIST CAP FOUND MAIN SHAFT AND MAGNET BROKEN DUE TO THE SEVERE RUNNING CONDITIONS WILL NEED TO REPAIRS FAIL COMPONENTS THEN RETEST FOR CONCERN MAY NEED MORE THAN JUST DISTRIBUTOR AND SECONDARY TUNE UP REPLACED DISTRIBUTOR RETIMED ENGINE ROAD TESTED MUCH BETTER NOTE PLUG WIRES RETENTION ARE LOOSE AND MAY POP OFF DIST CAP SPARK PLUGS ARE BLACK WITH SOOT CUSTOMER DECLINE ANY MORE REPAIRS AT THIS TIME

\*\*\*\*\*

B	PERFORM GOODWRENCH 27 POINT MULTI-POINT VEHICLE INSPECTION				
	27PT PERFORM GOODWRENCH 27 POINT MULTI-POINT VEHICLE INSPECTION				
	486 WHITE, BARRETT LIC#: 486				
	ICCB				
PARTS:	0.00	LABOR:	0.00	OTHER:	0.00
				TOTAL LINE B:	0.00

(N/PAID)  
JAN 25 2008  
*[Signature]*

44134 INSPECTED FOUND SOME MINOR OIL LEAKING PASS REAR BACKING PLATE SHOWS SLIGHT SEEPAGE TRANS PAN LEAKING FRONT PADS WORN

\*\*\*\*\*



ORIGINAL ESTIMATE \$	FINAL REVISED ESTIMATE \$	DESCRIPTION	TOTALS
		LABOR AMOUNT	
		PARTS AMOUNT	
		GAS, OIL, LUBE	
		SUBLET AMOUNT	
		HAZ. WASTE/MISC. CHARGES	
		TOTAL CHARGES	
		ADJUSTMENTS	
		SALES TAX	
I ACKNOWLEDGE NOTICE AND ORAL APPROVAL OF AN INCREASE IN THE ORIGINAL ESTIMATE PRICE. <input checked="" type="checkbox"/>		I ACKNOWLEDGE RECEIPT OF VEHICLE AND I HAVE RECEIVED A COPY OF THIS INVOICE. <input checked="" type="checkbox"/>	
		PLEASE PAY THIS AMOUNT	

NOTICE TO CONSUMER: PLEASE READ IMPORTANT INFORMATION ON BACK. CUSTOMER COPY

1013493

2 2 6 4 0 2

\*INVOICE\*

BE Y  
 3 AVE  
 SANTA ROSA, CA 95409-4054  
 HOME: ) BUS:  
 CELL: 7C 89

PAGE 2

BAR # AC 108903 EPA# CAD 981571615

SERVICE ADVISOR: 463 JASON TOSTADO

COLOR	YEAR	MAKE/MODEL	VIN	LICENSE	MILEAGE IN/ OUT	TAG
WHITE	88	CHEVROLET SUBURBAN	1GNGR26N3JF131139	2JHY101	44134/44136	T2413
IN SVC. DATE	PROD. DATE	PROMISED	PO NO.	PAYMENT	INV. DATE	
01JAN88 IS		17:00 21JAN08		0.00 CASH	25JAN08	
R.O. OPENED	DATE CLOSED	OPTIONS: ENG:7.4_Liter_FI_CPC				
07:32 21JAN08	16:15 25JAN08					

LINE	OPCODE	TECH	LIST	NET	TOTAL
EST: 135.00		21JAN08 07:32 SA: 463			

TIRE8 BK3

WERE YOU TOLD YOU MAY RECEIVE A SURVEY ABOUT THE SERVICE @ SANTA ROSA CHEVY? Y N

THANK YOU FOR YOUR BUSINESS. WE APPRICIATE IT!

**Santa Rosa**  
**CHEVROLET**

  
**ISUZU**

ORIGINAL ESTIMATE \$	FINAL REVISED ESTIMATE \$	DESCRIPTION	TOTALS
		LABOR AMOUNT	360.00
		PARTS AMOUNT	221.14
		GAS, OIL, LUBE	0.00
		SUBLET AMOUNT	0.00
		HAZ. WASTE/MISC. CHARGES	0.00
		TOTAL CHARGES	581.14
		ADJUSTMENTS	0.00
		SALES TAX	17.69
		<b>PLEASE PAY THIS AMOUNT</b>	<b>598.83</b>

I ACKNOWLEDGE NOTICE AND ORAL APPROVAL OF AN INCREASE IN THE ORIGINAL ESTIMATE PRICE.  X  
 I ACKNOWLEDGE RECEIPT OF VEHICLE AND I HAVE RECEIVED A COPY OF THIS INVOICE.  X



**NOTICE TO CONSUMER: PLEASE READ IMPORTANT INFORMATION ON BACK. CUSTOMER COPY**

## MULTI-POINT VEHICLE INSPECTION

Name: [Signature] Year/Model: 08 SES Date: 1-21-08

Repair Order #: 226402 VIN (last 8 digits): \_\_\_\_\_ Odometer: 47,174 MI: \_\_\_\_\_ MII: \_\_\_\_\_

Checked and OK  May Require Attention Soon  Requires Immediate Attention

INTERIOR		
<input checked="" type="checkbox"/> OnStar Subscription activated	<input checked="" type="checkbox"/> Remaining engine oil life: _____ % Reset: _____ N/A: _____	<input checked="" type="checkbox"/> Air Conditioning Performance
WIPER BLADES	CHECK TIRES AND TREAD DEPTH (Check body condition)	CHECK BATTERY
 <p>LF <input checked="" type="checkbox"/> RF <input checked="" type="checkbox"/></p> <p><input checked="" type="checkbox"/> Rear (if applicable)</p> <p><input checked="" type="checkbox"/> Windshield condition</p> <p>Cracks _____ Chips _____</p>	<p>8/32 or Greater <input checked="" type="checkbox"/></p> <p>7/32 to 4/32 <input checked="" type="checkbox"/></p> <p>3/32 or Less <input checked="" type="checkbox"/></p> <p>PSI@: _____ set to: _____ PSI</p> <p>8/32 or Greater <input checked="" type="checkbox"/></p> <p>7/32 to 4/32 <input checked="" type="checkbox"/></p> <p>3/32 or Less <input checked="" type="checkbox"/></p> <p>PSI@: _____ set to: _____ PSI</p> <p><input type="checkbox"/> Rotation needed <input type="checkbox"/> Alignment needed</p> <p><input type="checkbox"/> Rotation performed <input type="checkbox"/> Alignment performed</p> <p>Wear Pattern/Damage _____</p> <p>Lowest Tread Depth: <u>9</u> /32</p> <p><input type="checkbox"/> Balance needed <input type="checkbox"/> Balance performed</p> <p>RF <input type="checkbox"/> RR <input type="checkbox"/></p>	 <p><input checked="" type="checkbox"/> Battery condition</p> <p><input checked="" type="checkbox"/> Battery cables and connections</p>

CHECK FLUID LEVELS	CHECK BRAKES/MEASURE FRONT AND REAR LININGS														
<table border="1"> <thead> <tr> <th>OK / FILLED</th> <th>REQUIRES ATTENTION</th> </tr> </thead> <tbody> <tr> <td><input checked="" type="checkbox"/> Engine oil</td> <td><input type="checkbox"/></td> </tr> <tr> <td><input checked="" type="checkbox"/> Brake fluid reservoir</td> <td><input type="checkbox"/></td> </tr> <tr> <td><input checked="" type="checkbox"/> Transmission (if equipped w/dipstick) <u>leaking</u></td> <td><input checked="" type="checkbox"/></td> </tr> <tr> <td><input checked="" type="checkbox"/> Coolant recovery reservoir</td> <td><input type="checkbox"/></td> </tr> <tr> <td><input checked="" type="checkbox"/> Power steering <u>leaks</u></td> <td><input checked="" type="checkbox"/></td> </tr> <tr> <td><input checked="" type="checkbox"/> Windshield washer</td> <td><input type="checkbox"/></td> </tr> </tbody> </table>	OK / FILLED	REQUIRES ATTENTION	<input checked="" type="checkbox"/> Engine oil	<input type="checkbox"/>	<input checked="" type="checkbox"/> Brake fluid reservoir	<input type="checkbox"/>	<input checked="" type="checkbox"/> Transmission (if equipped w/dipstick) <u>leaking</u>	<input checked="" type="checkbox"/>	<input checked="" type="checkbox"/> Coolant recovery reservoir	<input type="checkbox"/>	<input checked="" type="checkbox"/> Power steering <u>leaks</u>	<input checked="" type="checkbox"/>	<input checked="" type="checkbox"/> Windshield washer	<input type="checkbox"/>	<p>7 mm (9/32) or greater <input checked="" type="checkbox"/></p> <p>6 mm (8/32) to 4 mm (5/32) <input checked="" type="checkbox"/></p> <p>3 mm (4/32) or less <input checked="" type="checkbox"/></p> <p>4 mm (5/32) or greater <input checked="" type="checkbox"/></p> <p>3 mm (4/32) <input checked="" type="checkbox"/></p> <p>2 mm (3/32) or less <input checked="" type="checkbox"/></p> <p>Lowest Front Lining <u>3</u> Lowest Rear Lining _____</p> <p><input checked="" type="checkbox"/> Brake system (also including lines, hoses and parking brake)</p>
OK / FILLED	REQUIRES ATTENTION														
<input checked="" type="checkbox"/> Engine oil	<input type="checkbox"/>														
<input checked="" type="checkbox"/> Brake fluid reservoir	<input type="checkbox"/>														
<input checked="" type="checkbox"/> Transmission (if equipped w/dipstick) <u>leaking</u>	<input checked="" type="checkbox"/>														
<input checked="" type="checkbox"/> Coolant recovery reservoir	<input type="checkbox"/>														
<input checked="" type="checkbox"/> Power steering <u>leaks</u>	<input checked="" type="checkbox"/>														
<input checked="" type="checkbox"/> Windshield washer	<input type="checkbox"/>														

ADDITIONAL CHECKS	Additional Recommended Services
<input checked="" type="checkbox"/> Inspect for visible leaks:	1) <u>front pads low</u>
<input checked="" type="checkbox"/> Fuel system (also including gas cap seating)	2) <u>possible RR Axle Seal Seep</u>
<input checked="" type="checkbox"/> Engine, transmission, drive axle, transfer case <u>leaks</u>	3) <u>PIS CAN NOT SEE LEAKING</u>
<input checked="" type="checkbox"/> Engine cooling system	4) _____
<input checked="" type="checkbox"/> Shocks and struts – also check operation	5) _____
<input checked="" type="checkbox"/> Inspect visual condition:	6) _____
<input checked="" type="checkbox"/> Belts: engine, accessory, serpentine, and/or V-drive	7) _____
<input checked="" type="checkbox"/> Hoses: engine, power steering and HVAC	8) _____
<input checked="" type="checkbox"/> Engine air filter and cabin air filters	Service Consultant: _____
<input checked="" type="checkbox"/> Steering components and steering linkage <u>minifer bar</u>	Technician: <u>LFB</u> No.: _____
<input checked="" type="checkbox"/> CV drive axle boots or driveshafts and U-joints	
<input checked="" type="checkbox"/> Exhaust system components	

### SIMPLIFIED MAINTENANCE

MI  Required  Performed

MII  Required  Performed

Thank you for checking out my Suburban. Attached is the most recent evaluation, all of which may be valid, but I need some advice I can trust. As you can see, the vehicle has not been driven much since this January invoice at 44,136 miles. (It's 144,136 original miles, original owner, me)

- New engine and re-built transmission at 113,000 in 2001
- AC disconnected intentionally - chosen not to repair it
- New distributor in January - It "coded" and quit running
- Vehicle runs now. It does seem a little rough - maybe I imagine
- I can see small amounts of "something" on garage floor. I'm aware we have seepage somewhere.
- Last oil change is noted on upper left windshield

What needs to be done? What's priority?

Please call and we'll talk, decide, go for it.

Thanks again!

Lin  
If I don't pick up, leave a message. I'll be in and out of appointments today and will check regularly for a call.



226402

\*INVOICE\*

PAGE 1

SERVICE ADVISOR: 463 JASON TOSTADO

BEIT  
3935 AVE  
SANTA ROSA, CA 95409-4054  
HOME: 707 BUS:  
CELL: 707 9

COLOR	YEAR	MAKE/MODEL	VIN	LICENSE	MILEAGE IN/ OUT	TAG
WHITE	88	CHEVROLET SUBURBAN	1GNCR26N3JF131139	2JHY101	44134/44136	T2413
IN SVC. DATE	PRGD. DATE	PROMISED	PO NO	PAYMENT	INV. DATE	
01JAN88 IS		17:00 21JAN08		0.00 CASH	25JAN08	

R.O. OPENED	DATE CLOSED	OPTIONS:
07:32 21JAN08	16:15 25JAN08	ENG:7.4_Liter_FI_CPC

LINE	OPCODE	TECH	LIST	NET	TOTAL
A CUSTOMER STATES THAT THE SERVICE ENGINE SOON LIGHT IS ON. AFTER 5 MINUTES THE VEHICLE RUNS ROUGH AND WANTS TO QUIT. INSPECT AND ADVISE. L100.					
110 GAS ENGINE					
486 WHITE, BARRETT LIC#: 486					
CCT					
1	10108445	GASKET	1.19	1.19	1.19
1	1103952	DISTRIBUT	244.29	219.95	219.95
PARTS: 221.14			LABOR: 360.00	OTHER: 0.00	TOTAL LINE A: 581.14

44136 INSPECTED FOR ROUGH RUN AND SERVICE LAMP FOUND CODE 45 RICH VEHICLE RUNS VERY POOR SECONDARY IGNITION IS FAILING PLUG WIRES ARE 20 YEARS OLD AND RUSTY REMOVED DIST CAP FOUND MAIN SHAFT AND MAGNET BROKEN DUE TO THE SEVERE RUNNING CONDITIONS WILL NEED TO REPAIRS FAIL COMPONENTS THEN RETEST FOR CONCERN MAY NEED MORE THAN JUST DISTRIBUTOR AND SECONDARY TUNE UP REPLACED DISTRIBUTOR RETIMED ENGINE ROAD TESTED MUCH BETTER NOTE PLUG WIRES RETENTION ARE LOOSE AND MAY POP OFF DIST CAP SPARK PLUGS ARE BLACK WITH SOOT CUSTOMER DECLINE ANY MORE REPAIRS AT THIS TIME

*****					
LINE	OPCODE	TECH	LIST	NET	TOTAL
B PERFORM GOODWRENCH 27 POINT MULTI-POINT VEHICLE INSPECTION					
27PT PERFORM GOODWRENCH 27 POINT MULTI-POINT VEHICLE INSPECTION					
486 WHITE, BARRETT LIC#: 486					
ICCB					
PARTS: 0.00			LABOR: 0.00	OTHER: 0.00	TOTAL LINE B: 0.00

44134 INSPECTED FOUND SOME MINIOR OIL LEAKING PASS REAR BACKING PLATE SHOWS SLIGHT SEEPAGE TRANS PAN LEAKING FRONT PADS WORN

\*\*\*\*\*



ORIGINAL ESTIMATE \$	FINAL REVISED ESTIMATE \$	DESCRIPTION	TOTALS
DATE TIME PHONE # OR IN PERSON AUTHORIZED BY ADDITIONAL AMOUNT		LABOR AMOUNT	
REASON		PARTS AMOUNT	
DATE TIME PHONE # OR IN PERSON AUTHORIZED BY ADDITIONAL AMOUNT		GAS, OIL, LUBE	
REASON		SUBLET AMOUNT	
DATE TIME PHONE # OR IN PERSON AUTHORIZED BY ADDITIONAL AMOUNT		HAZ. WASTE/MISC. CHARGES	
REASON		TOTAL CHARGES	
DATE TIME PHONE # OR IN PERSON AUTHORIZED BY ADDITIONAL AMOUNT		ADJUSTMENTS	
REASON		SALES TAX	
I ACKNOWLEDGE NOTICE AND ORAL APPROVAL OF AN INCREASE IN THE ORIGINAL ESTIMATE PRICE. X		PLEASE PAY THIS AMOUNT	
I ACKNOWLEDGE RECEIPT OF VEHICLE AND I HAVE RECEIVED A COPY OF THIS INVOICE. X			

NOTICE TO CONSUMER: PLEASE READ IMPORTANT INFORMATION ON BACK. CUSTOMER COPY

CUSTOMER INFORMATION		TAG #	VEHICLE INFORMATION YEAR / MAKE / MODEL		INITIAL ESTIMATE	REVISED ESTIMATE	CREATED BY
NAME: ADDRESS: CITY/ST/ZIP: HOME PHONE:			LICENSE #	COLOR	PARTS		
5719 - SEARS 99 Santa Rosa Plaza Santa Rosa, CA 95401 (707) 571-5488			1998 CHEVROLET TRUCK R/V 10,20,30 P/U, SUB V8-454 V.I.N.:	WHITE BLUE LOCATION	LABOR		INVOICED BY: Y3
STORE INFORM 54			2144101 TIME IN:	10M252LWQJF131139 TAL CURR: ODOMETER IN	OTHER \$49.17 TAX \$12.99 TOTAL \$62.16		
			10/01/2007 11:21 AM	10/01/2007 11:33 AM	DATE/TIME OF ESTIMATE: 10/01/2007 11:21 AM	DATE/TIME OF REVISED:	PAYMENT TYPE: CASH <input type="checkbox"/> CREDIT <input type="checkbox"/> CHECK <input type="checkbox"/>
WAITING Number	DROP-OFF	PROMISED TIME	TIRE INSTALLATION INSTRUCTIONS		PHONE AUTHORIZATION <input type="checkbox"/>	PHONE NUMBER CALLED	
Repair Number: AF02260			LF RF SP BW WW LR RR SAVE OLD TIRES Y ROWL N	11:21 AM			
REFERENCE NUMBER	PRINTED ON				CONTACTED BY	DATE	TIME
NO YES	10/01/2007 12:01 PM						
CUSTOMER COMMENTS			AIR PRESSURE FRONT / REAR		<b>See reverse for important warranty terms and other information.</b>		
IN48350 LPP06 48350		10/01/2007 11:36 AM	WHL. TORQUE SPECIFICATION		CUSTOMER WORK AUTHORIZATION X <i>Betty Vannoy</i>		

QTY.	ITEM #	DESCRIPTION OF MERCHANDISE	PRICE EA.	EXTENSION	TECH.
		Battery			

Parts SubTotal : \$49.17  
 Labor SubTotal : \$12.99  
 Reductions SubTotal : \$0.00  
 SubTotal : \$62.16  
 Tax : 8.000% \$5.93  
 Total : \$68.09

RD: 0427-0769-6556-3197  
 Credit Tended : \$68.09

CARDTYPE : VISA  
 ACCT # : WXXXXXXXXXX1657  
 AUTH CODE : 03431E  
 VISA TOTAL: \$68.09

CARDHOLDER ACKNOWLEDGES RECEIPT OF GOODS AND/OR SERVICES IN THE AMOUNT OF \$68.09 AND AGREES TO PERFORM THE OBLIGATIONS SET FORTH IN THE CARDHOLDER'S AGREEMENT WITH THE ISSUER IDENTIFIED HEREON

*Betty Vannoy*  
 PURCHASED BY

SALES CHECK # 067150495960

SATISFACTION GUARANTEED

*Thank you for the opportunity to serve you.*  
 Our goal is to provide Fast, Expert Service.  
 Please keep us in mind for your future automotive needs.

A 15% Restocking Fee may apply on returned merchandise  
 A 15% Cancellation Fee may apply on Special Ordered merchandise cancelled after 24 hours  
 See Salesperson for details

RETURN OLD PARTS TO CUSTOMER  (Page 2 of 2)

YOU ARE ENTITLED TO RECEIVE REPLACED AND REMOVED PARTS, OTHER THAN EXCHANGED OR WARRANTED PARTS WHICH WILL BE AVAILABLE FOR YOUR INSPECTION TO OBTAIN FULL WARRANTY BENEFITS, YOU MUST PRESENT YOUR RECEIPT AND THE DEFECTIVE PRODUCT OR THE VEHICLE ON WHICH THE SERVICE WAS PERFORMED.

CUSTOMER INFORMATION		TAG #	VEHICLE INFORMATION YEAR / MAKE / MODEL		INITIAL ESTIMATE	REVISED ESTIMATE	CREATED BY
NAME: ADDRESS: CITY/ST/ZIP: HOME PHONE: 571-5638			LICENSE #	COLOR	PARTS		
STORE INFORMATION: 6718 - S E A R S 98 Santa Rosa Plaza Santa Rosa, CA 95401 (707) 571-5638			1988 CHEVROLET TRUCK R4V 10,20,30 F/U.SUB V8-454 V.I.N.	LOCATION	LABOR		INVOICED BY: 73
			TIME IN	WHITE BLUE	OTHER \$49.17		
			ODOMETER IN	TIME OUT	TAX \$12.99		
			10/01/2007 11:21 AM	10/01/2007 11:33 AM	TOTAL \$0.00		
			43590		DATE/TIME OF ESTIMATE 10/01/2007 11:21 AM	DATE/TIME OF REVISED	PAYMENT TYPE
					\$66.05		CASH <input type="checkbox"/>
WAITING NUMBER	DROP-OFF	PROMISED TIME	TIRE INSTALLATION INSTRUCTIONS		PHONE AUTHORIZATION	PHONE NUMBER CALL	
Repair Number: AF022604			LF RF SP BW WW	LOCKS	11:21 AM		
REFERENCE NUMBER	PRINTED ON		LR RR SAVE OLD TIRES	Y N	CONTACTED BY DATE TIME		
NO YES	10/01/2007 12:01 PM						
CUSTOMER COMMENTS		AIR PRESSURE FRONT / REAR		See reverse for important warranty terms and other information.			
ING#482350 LPP# 482350		10/01/2007 11:36 AM		CUSTOMER WORK AUTHORIZATION			
REPLACE BATTERY #4912559 8-26-02				X <i>Beth Warner</i>			

QTY.	ITEM #	DESCRIPTION OF MERCHANDISE	REFERENCE PRICE	EXTENSION	TECH.
1	PE 22833078	DIEHARD GOLD GRP 78	\$99.99	\$99.99	A8900
1	RC 082027	CORE VALUE TAX	\$0.80	\$0.80	517193
1	LR 19021010	DIEHARD SERVICE BATTERY	\$12.99	\$12.99	517193
1	RT 22833078	BATTERY ADJUSTMENT	-\$50.82	-\$50.82	517193
1	RT 082027	CORE VALUE TAX	-\$0.80	-\$0.80	517193

RETAIN FOR COMPARISON WITH MONTHLY STATEMENT OR FOR RETURN OR EXCHANGE

22833078 QTY:1  
DIEHARD GOLD GRP \$99.99T  
(ORIG. SELLING PRICE OF \$109.99 LESS \$10.00 CORE VALUE)

082027 QTY:1  
CORE VALUE TAX \$0.80

19021010 QTY:1  
DIEHARD SERVICE \$12.99

22833078 QTY:1  
BATTERY ADJUSTME -\$50.82T  
(ORIG. SELLING PRICE OF \$60.82 LESS \$10.00 CORE VALUE)

082027 QTY:1  
CORE VALUE TAX -\$0.80

TOTALS ON NEXT PAGE

ALL NEW, NON-OEM PARTS UNLESS OTHERWISE SPECIFIED.

ITEM / WARRANTY INFORMATION / CSA COMMENTS / TECHNICIAN COMMENTS

Aftermarket TPMS Available. Verify TPMS.  
WARRANTY:  
22833078 : 36 Months Full Replacement Warranty - 100 Months Pro-rated Warranty

ALL LUG NUTS ON CUSTOM AND ALLOY WHEELS MUST BE RE-TORQUED AFTER 25 MILES AND CHECKED PERIODICALLY.  
If you did not receive your Survey Coupon today with this invoice, please see the Customer Service Manager.

ITEM COMMENTS:  
22833078: Designed for your climate. CCA's and RC's are determined in accordance with Industry Standards at time of manufacture. BATTERIES INCLUDE A CORE VALUE AND ARE ASSESSED TAX BASED ON STATE REQUIREMENTS.  
19021010: STARTING AND CHARGING SERVICE; ADJUST BELTS IF REQUIRED, STARTING & CHARGING SYSTEMS TEST, CORROSION PROTECTION, CLEAN CABLE ENDS, TRAY IF REQUIRED, INCLUDES R&P OF BATTERY IF NEEDED.

*Thank you for the opportunity to serve you.*  
Our goal is to provide Fast, Expert Service.  
Please keep us in mind for your future automotive needs.

A 15% Restocking Fee may apply on returned merchandise  
A 15% Cancellation Fee may apply on Special Ordered merchandise cancelled after 24 hours  
See Salesperson for details

RETURN OLD PARTS TO CUSTOMER  Y  N

Customer's reason for bringing in vehicle

Repla Battery

Dtt Saved  
under warranty



VALUED CUSTOMER INFORMATION

VEHICLE INFORMATION

NAME: [Handwritten]  
PHONE: [Handwritten]

YEAR: 87  
MAKE: Chev

LIC. PLATE: 2JH4 101  
COLOR: White/Blue

CSA NOTES: 542-8070  
Home  
4912559 8-26-03

MODEL: Suburban  
ODOMETER IN: 43890  
VIN# 1GNBR26N3JF131139  
(if required for commercial customer)

ENGINE SIZE: 7.4L  
WHEEL LOCKS: Y / N  
WHEEL KEY LOCATION: \_\_\_\_\_

CURRENT RIDE CONDITIONS

TIRE TYPE & TREAD WEAR

Is the steering wheel straight? Y / N  
Is the vehicle pulling? Y / N Left/Right  
Is the vehicle vibrating? Y / N At what speed? \_\_\_\_\_  
During braking? Y / N If Yes, refer to Current Brake Conditions (below)

FRONT TIRE SIZE: P/XL/LT \_\_\_\_\_ / \_\_\_\_\_ / \_\_\_\_\_ Performance Rating \_\_\_\_\_

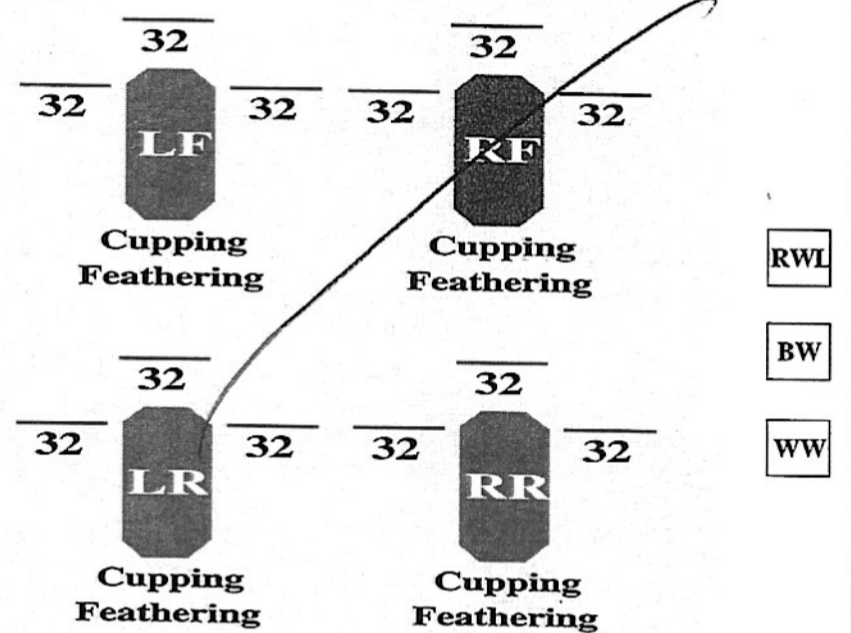

CURRENT BRAKE CONDITIONS

REAR TIRE SIZE: P/XL/LT \_\_\_\_\_ / \_\_\_\_\_ / \_\_\_\_\_ Performance Rating \_\_\_\_\_

Is brake light on? Y / N  
Is ABS light on? Y / N  
Is there a noise when braking? Y / N  
Does vehicle pull when braking? Y / N  
Does pedal pulsate? Y / N  
Is brake pedal low? Y / N

LF RF SAVE OLD TIRES Y / N  
LR RR COMMENTS:  
SP

TECH NOTES

Express Services

- DieHard® SERVICE 33078 Dtt Gold R-3 \$ 12.99  
 DieHard SERVICE AND ADVISE (SABRE Printout)  
 IN-WARRANTY BATTERY AND DieHard SERVICE

- OIL CHANGE \$ \_\_\_\_\_  
Would you like to have your air filter replaced? Y  N  
Would you like your wiper blades replaced? Y  N \$ \_\_\_\_\_ EA.  
Would you like your coolant exchanged? Y  N

- COOLANT EXCHANGE \$ \_\_\_\_\_
- A/C RECHARGE \$ \_\_\_\_\_
- OTHER \_\_\_\_\_ \$ \_\_\_\_\_

Customer Authorization: I hereby authorize the repair facility to operate my vehicle and perform service(s) as described above. I acknowledge that the charge for this service, if any, is disclosed above. Additional parts and services are extra.

CUSTOMER SIGNATURE [Handwritten Signature]

DATE 10-1-07



# ROSELAND SMOG, INC.

440 Dutton Ave. #3 • SANTA ROSA, CA 95407

A.R.D. # AE-239502

707-569-8112

No 17786

## SMOG TEST-ONLY INVOICE

NAME	TODAY'S DATE	YEAR	MAKE	MODEL
ADDRESS	3/15/07	88	Chevy	Silverado
CITY, STATE, ZIP	ODOMETER	LIC. PLATE #	MOTOR #	
HOME PHONE	44356	2JH4101		
<input type="checkbox"/> WORK <input type="checkbox"/> CELL <input type="checkbox"/> PAGER	WRITTEN BY	CUSTOMER P.O. #	G.V.W.R.	
METHOD OF PAYMENT: <input type="checkbox"/> CASH <input type="checkbox"/> CHECK <input type="checkbox"/> CHARGE <input type="checkbox"/> DEBIT CARD <input type="checkbox"/> CREDIT CARD	TEST TYPE: <input checked="" type="checkbox"/> BIENNIAL <input type="checkbox"/> CHANGE OF OWNERSHIP <input type="checkbox"/> 2% <input type="checkbox"/> HEP <input type="checkbox"/> INITIAL	ENGINE	# OF CYLINDERS	
ORIGINAL ESTIMATE \$ 75.00	<input type="checkbox"/> FED. <input type="checkbox"/> CALIF. <input type="checkbox"/> O/S	TRANSMISSION: <input type="checkbox"/> AUTO <input type="checkbox"/> STD	TIMING	EM. LIGHT
	V.I.N.	1G1ER26N38F131139		

SMOG TEST CHECK OFF					
P-Pass	M-Modified	F-Defective	D-Disconnected	S-Missing	N-N/A
<input checked="" type="checkbox"/>	<input checked="" type="checkbox"/>	<input checked="" type="checkbox"/>	<input checked="" type="checkbox"/>	<input checked="" type="checkbox"/>	<input checked="" type="checkbox"/>
PCV			C/I		
TAC			AP/P		
EVP			OXY		
CAT			WRG		
EGR			VAC		
SPK			OTH		

*[Signature]*

OPR.	DESCRIPTION OF WORK	AMOUNT
	SMOG TEST	
	PRETEST <input type="checkbox"/> YES <input type="checkbox"/> NO	
	CERTIFICATE #	
	ELECTRONIC TRANSFER FEE (E.T.F.)	
	RETEST	
	GAS CAP-	
	DISCOUNT	\$1000

TEST RESULTS:  PASS  FAIL  ABORT

**THIS SMOG TEST-ONLY STATION CANNOT PERFORM ANY DIAGNOSTICS, ADJUSTMENTS OR REPAIRS**

I hereby authorize the above smog test to be performed. Smog test fee is due whether above vehicle passes or fails the smog test. You and your employees may operate above vehicle for purposes of testing, inspection and delivery at my risk. An express mechanic's lien is acknowledged on above vehicle to secure the amount of this invoice. You will not be held responsible for loss or damage to vehicle due to fire, theft, accident, dynamometer testing or any other cause beyond your control. In the event legal action is necessary to enforce this contract, I understand that I am solely responsible for all costs including attorney's fees and court costs. I have read and understand the above and acknowledge receipt of an estimate.

X *Beth Henry* DATE \_\_\_\_\_

REVISIONS: \_\_\_\_\_ DATE \_\_\_\_\_ TIME \_\_\_\_\_ PHONE • FAX • EMAIL \_\_\_\_\_  PHONE  EMAIL  IN PERSON  FAX

REASON: \_\_\_\_\_ ADDITIONAL COST \$ \_\_\_\_\_

I acknowledge notice and oral approval of an increase in the original estimated price. X

TOTAL WORK	
CERTIFICATE	
E.T.F.	
SUB TOTAL	
SALES TAX	
GRAND TOTAL	

# SMOG CHECK VEHICLE INSPECTION REPORT

(03/15/2007 @ 4:33:22 pm)

## Vehicle Information

Model Year.....	1988	Make.....	CHEVROLET	Model.....	K20 SUBURBAN
License.....	2JHY101	State.....	California	VIN.....	1GN3R26N3JF131139
Engine Size.....	7.4 Liters	Type.....	Truck	Transmission.....	Automatic
GVWR.....	7200 lbs.	Test Weight.....	5250 lbs.	Cylinders.....	8
Odometer.....	42386	Certification.....	California	VLT Record #.....	40615
Fuel Type.....	Gasoline	Exhaust.....	Single	Inspection Reason.....	HEP
Engine Year.....	N/A	Engine Make.....	N/A	Bar Number.....	N/A
Fleet BAR File #.....	N/A				

## Overall Test Results

Congratulations! Your vehicle passed the enhanced Smog Check inspection, which helps California reach its daily goal of removing an extra 100 tons of smog-forming emissions from the air. Thank you for keeping your vehicle well maintained.

Visual Inspection..(Pass) Functional Check..(Pass) Emissions Test..(Pass)

DMV ID Number..(3173Q012M509)

Smog Check Certificate Number..(MQ239825)

Your Smog Check certificate has been electronically transmitted to the DMV.  
This certificate is valid for ninety (90) days from the date of issuance.

Please keep this copy for your records.

## Emission Control Systems Visual Inspection/Functional Check Results

(Visual/Functional tests are used to assist the identification of oxides of nitrogen, crankcase, and cold start emissions which are not measured during the idle tests)

<u>ECS</u>	<u>Result</u>	<u>ECS</u>	<u>Result</u>	<u>ECS</u>	<u>Result</u>
PCV.....	Pass	Thermostatic Air Cleaner.....	Pass	Fuel Evaporative Controls.....	Pass
Catalytic Converter.....	Pass	EGR (Visual).....	Pass	Spark Controls.....	Pass
Fuel Injection.....	Pass	Pump Air Injection.....	Pass	Oxygen Sensor.....	Pass
Wiring to Sensors.....	Pass	Vacuum lines sensors/switches..	Pass	Other related emis. components.	Pass
Liquid Fuel Leak.....	Pass	Fuel Cap Integrity Test.....	Pass	Fuel Cap Visual.....	Pass
Malfunction Indicator Light....	Pass	Ignition Timing (06 BTDC).....	Pass		

# SMOG CHECK VEHICLE INSPECTION REPORT

(03/15/2007 @ 4:33:22 pm)

Page # 2

VIN..... 1GNGR26N3JF131139

License.. 2JHY101

## ASM Emission Test Results

Test	RPM	%CO2	%O2	HC (PPM)			CO (%)			NO (PPM)			Result
	MEAS	MEAS	MEAS	MAX	AVE	MEAS	MAX	AVE	MEAS	MAX	AVE	MEAS	
M1: 15 MPH	1413	14.9	0.3	112	51	12	0.60	0.12	0.03	975	301	247	Pass
M2: 25 MPH	1358	15.2	0.2	92	37	10	0.79	0.09	0.02	835	241	169	Pass

MAX = Maximum Allowed Emissions    AVE = Average Emissions For Passing Vehicles    MEAS = Amount Measured

## Smog Check Station Information

ROSELAND SMOG  
440 DUTTON AVE.#3  
SANTA ROSA, CA 95407  
1 707 569 8112

Technician Name/Number..... MAYO GEOFFREY S/EA135649  
Repair Tech Name/Number..... N/A  
Software Version/EIS Number... 0311/SX031070  
Station Number..... TE239502

I certify under the penalty of perjury under the laws of the State of California, That I performed the inspection in accordance with all bureau requirements, and that the information listed on this vehicle inspection report is true and correct.

Date

Technician's Signature

2005



\*\*\*\*\* PRICE QUOTATION \*\*\*\*\*

PRICES GOOD FOR 30 DAYS.

Store ..... 655 LES SCHWAB TIRE CENTER  
1914 Mendocino Ave  
Santa Rosa, CA 95401 3631  
707-541-7332  
BAR# AC238352

Quote# ..... 702  
Invoice# ...  
Page# ..... 1

Customer Name ..... 88 SUBURBAN (G BOX)  
Address .....  
City, State, Zip ...  
Phone .....

Date ..... 6/29/2005  
Time ..... 8:47:19 AM  
License# .....  
Year ..... 1988  
Make ..... GMC TRUCK  
Model ..... R+V 1500-3500 PU,SUB

Salesman ..... JUSTIN  
JC

Comments .....

Qty	Product Code	Product Description	Price	FET	Amount
-----	--------------	---------------------	-------	-----	--------

ALL PARTS NEW UNLESS SPECIFIED

1	57280220	51-7522 REMANUFACTURED ST. GEAR	235.91		235.91
1	00680350	STEERING GEARS INSTALLATION	84.50		84.50
1	00680112	THRUST ANGLE ALIGNMENT - DOMESTIC/IMPORT CARS, PICKUPS, VANS	45.95		45.95

Sales Tax: 18.87  
Tire Tax: .00  
QUOTATION Total: 385.23

Customer Signature: \_\_\_\_\_ Estimate Decision: \_\_\_\_\_

Revised Estimate: \_\_\_\_\_ In Person Phone#: \_\_\_\_\_

Customer Signature: \_\_\_\_\_ Date: \_\_\_\_\_ Time: \_\_\_\_\_

2005





**MIDAS SHOP**  
 131 COLLEGE AVE.  
 SANTA ROSA, CA 95401  
 707-527-9310

Invoice #0058219

Date : 6/29/05

Page : 1

Center :

EPA# 000018266

BAR# AG234970

Customer :  
 Address : :A  
 City : SANTA ROSA, CA 95409-  
 Phone 1 : ( 707 ) : Ext :  
 Phone 2 : ( 707 ) - Ext :

Vehicle : 1988 CHET SUBURBAN  
 License : 2JHY101  
 VIN :  
 Engine : V8/7.4/454  
 Mileage : 39502  
 Trans : AUTO

Op	Tech	Description	Labor	Parts	Subtotal
OH	Quan	Part Number	Part Description	Reason for Replacement	Price
Estimate Approvals: Original Approval Date: 6/29/2005 10:15:00 AM Reason: EXHAUST INSPECTION Amount: \$0.00 Auth By: REX VAN NOY Contacted In Person Phone: (707) 542-8070 By: DENNIS Revised Approval: 6/29/2005 10:26:00 AM Reason: EXHAUST GASKETS, LABOR Amount: \$160.33 Auth By: REX VAN NOY Contacted By Phone Difference from Previous Approval: \$160.33 Phone: (707) 542-8070 By: DENNIS					
00	00	21	INSPECT EXHAUST SYSTEM FOR LEAKS/NOISE		0.00
15	0	21	Labor Charged to Remove & Replave Exhaust Gaskets		134.52
	2.00	EN1945	FLANGE GASKET	FRONT-BOTH	23.90
1	00	21	Remove Resonator and Replace with Pipe		Decline 0.00
	1.00	1E10009	EXHAUST PIPE	LOWER	Declined

**Experience The Midas Touch**  
 Install protective coverings on steering wheel, seats and floor mats  
 Inspect lighting system, inspect tires and adjust tire pressure  
 Check oil level and Perform Midas Courtesy Check Inspection

**WARRANTY INFORMATION**

Midas International Corporation issues written warranties on mufflers, catalytic converters, shock absorbers, strut assemblies, strut cartridges, brake shoes and pads, and variable rate springs. The warranty terms for these products are stated on separate printed warranty certificates issued to you, together with the invoice, upon the purchase of the appropriate warranted product. The terms of all warranties are in the Midas Warranty Binder on display in each Midas location.

All other products and workmanship are warranted for ninety (90) days from the date of installation. There are no other warranties issued by Midas International Corporation.

*This warranty gives you specific legal rights; you may also have other rights which vary from state to state.*

Warranty work will be performed at any Midas location in the USA or Canada offering the warranted product of service. For the address of your nearest Midas location, see the Yellow pages of the local telephone directory or write Midas Consumer Relations, 1300 Arlington Heights Road, Itasca, IL. 60143. I hereby authorize you and/or your agents to contact me regarding the products and services provided at Midas.

**Thank You For Your Patronage!**

Labor :	\$134.52
Parts :	\$23.90
Sublet :	\$0.00
Other Fees :	\$0.00
	\$0.00
Subtotal :	\$158.42
Sales Tax :	\$1.91
Paid By :	Total :
MSTR CHARG VISA	\$160.33
Pay Ref :	Paid :
	\$160.33
	Due :
	\$0.00



**MIDAS SHOP**  
**131 COLLEGE AVE.**  
**SANTA ROSA, CA 95401**  
**707-527-9310**

Repair Order # **0058219**

Date : **6/29/05**

Page : **1**

Center :

EPA# **000018266**

BAR# **AG234970**

Customer :

Address : \_\_\_\_\_ A

City : **SANTA ROSA, CA 95409-**

Phone 1 : ( 707 \_\_\_\_\_ Ext :

Phone 2 : ( 707 ) - \_\_\_\_\_ Ext :

Vehicle : **1988 CHET SUBURBAN**

License : **2JHY101**

VIN :

Engine : **V8/7.4/454**

Trans : **AUTO**

Mileage : **39502**

Op	Tech	Description	Part Description	Reason for Replacement	Labor	Parts	Subtotal
OH	Quan	Part Number				Price	
Estimate Approvals: Original Approval Date: 6/29/2005 10:15:00 AM Reason: EXHAUST INSPECTION Amount: \$0.00 Auth By: REX VAN NOY Contacted In Person Phone: (707) 542-8070 By: DENNIS Revised Approval: 6/29/2005 10:26:00 AM Reason: EXHAUST GASKETS, LABOR Amount: \$160.33 Auth By: REX VAN NOY Contacted By Phone Difference from Previous Approval: \$160.33 Phone: (707) 542-8070 By: DENNIS							
00	00	21	INSPECT EXHAUST SYSTEM FOR LEAKS/NOISE		0.00		
15	0	21	Labor Charged to Remove & Replave Exhaust Gaskets		134.52	23.90	158.42
	2	2.00	EN1945 FLANGE GASKET	FRONT-BOTH		23.90	
1	00	21	Remove Resonator and Replace with Pipe		Decline	0.00	
	0	1.00	1E10009 EXHAUST PIPE	LOWER		Declined	

**Experience The Midas Touch**  
 Install protective coverings on steering wheel, seats and floor mats  
 Inspect lighting system, inspect tires and adjust tire pressure  
 Check oil level and Perform Midas Courtesy Check Inspection

**WARRANTY INFORMATION**

Midas International Corporation issues written warranties on mufflers, catalytic converters, shock absorbers, strut assemblies, strut cartridges, brake shoes and pads, and variable rate springs. The warranty terms for these products are stated on separate printed warranty certificates issued to you, together with the invoice, upon the purchase of the appropriate warranted product. The terms of all warranties are in the Midas Warranty Binder on display in each Midas location.

All other products and workmanship are warranted for ninety (90) days from the date of installation. There are no other warranties issued by Midas International Corporation.

*This warranty gives you specific legal rights; you may also have other rights which vary from state to state.*

Warranty work will be performed at any Midas location in the USA or Canada offering the warranted product of service. For the address of your nearest Midas location, see the Yellow pages of the local telephone directory or write Midas Consumer Relations, 1300 Arlington Heights Road, Itasca, IL. 60143. I hereby authorize you and/or your agents to contact me regarding the products and services provided at Midas.

**Thank You For Your Patronage!**

Labor : \$134.52  
 Parts : \$23.90  
 Sublet : \$0.00  
 Other Fees : \$0.00  
 Subtotal : \$158.42  
 Sales Tax : \$1.91

Paid By : Total : \$160.33  
 Pay Ref : Paid : \$0.00  
 Due : \$160.33



**MIDAS SHOP**  
 131 COLLEGE AVE.  
 SANTA ROSA, CA 95401  
 707-527-9310

Repair Order #**0058219**  
 Date : 6/29/05  
 Page : 1  
 Center :

EPA# 000018266

BAR# AG234970

<b>Customer :</b> <b>Address :</b> City : SANTA ROSA, CA 95409- Phone 1 : ( 707 )                      Ext : Phone 2 : ( 707 )                      Ext :	<b>Vehicle :</b> 1988 CHET SUBURBAN <b>License :</b> 2JHY101 <b>VIN :</b> <b>Engine :</b> V8/7.4/454 <b>Mileage :</b> 39502 <b>Trans :</b> AUTO
---	--

Op	Tech	Description	Labor	Parts	Subtotal
OH	Quan	Part Number	Part Description	Reason for Replacement	Price
Estimate Approvals: Original Approval Date: 6/29/2005 10:15:00 AM Reason: EXHAUST INSPECTION Amount: \$0.00 Auth By: REX VAN NOY Contacted In Person Phone: (707) 542-8070 By: DENNIS					
00	00	21	INSPECT EXHAUST SYSTEM FOR LEAKS/NOISE		0.00

**Experience The Midas Touch**  
 Install protective coverings on steering wheel, seats and floor mats  
 Inspect lighting system, inspect tires and adjust tire pressure  
 Check oil level and Perform Midas Courtesy Check Inspection

**WARRANTY INFORMATION**

Midas International Corporation issues written warranties on mufflers, catalytic converters, shock absorbers, strut assemblies, strut cartridges, brake shoes and pads, and variable rate springs. The warranty terms for these products are stated on separate printed warranty certificates issued to you, together with the invoice, upon the purchase of the appropriate warranted product. The terms of all warranties are in the Midas Warranty Binder on display in each Midas location.

All other products and workmanship are warranted for ninety (90) days from the date of installation. There are no other warranties issued by Midas International Corporation.

*This warranty gives you specific legal rights; you may also have other rights which vary from state to state.*

Warranty work will be performed at any Midas location in the USA or Canada offering the warranted product of service. For the address of your nearest Midas location, see the Yellow pages of the local telephone directory or write Midas Consumer Relations, 1300 Arlington Heights Road, Itasca, IL. 60143. I hereby authorize you and/or your agents to contact me regarding the products and services provided at Midas.

**Thank You For Your Patronage!**

Labor :	\$0.00
Parts :	\$0.00
Sublet :	\$0.00
Other Fees :	\$0.00
Subtotal :	\$0.00
Sales Tax :	\$0.00
Paid By :	Total : \$0.00
Pay Ref :	Paid : \$0.00
	Due : \$0.00



# CUSTOMER SERVICE REQUEST

## CSR NO. E 777963

STORE STAMP

NAME		TELEPHONE (HOME)	TELEPHONE (WORK)	EXT.	DATE
		( ) ( ) ( )	( ) ( ) ( )		6-29-05
Have you been in our Midas shop before?			Have we serviced this vehicle before?		
<input type="checkbox"/> Yes <input checked="" type="checkbox"/> No			<input type="checkbox"/> Yes <input checked="" type="checkbox"/> No		
ADDRESS		CITY-STATE/PROVINCE		ZIP/POSTAL CODE	
3935 ALTA VISTA		SA		09	
YEAR	MAKE	MODEL	VIN	ENGINE/DISPLACEMENT	
88	Chev	Suburban 20		7.4 A	
ESTIMATE NO.		ODOMETER	LICENSE NO. & STATE/PROVINCE		
		39502	2JHY101		
		TIME			
		APPT.	ARRIVED	INSP.	PROMISED
		NO	1005		
		COMPLETED			

Customer's Description of Symptoms or Needs: EXHAUST INSP

Is there an alarm system?.....	<input type="checkbox"/> YES	<input type="checkbox"/> NO	<input type="checkbox"/> <b>CUSTOMER WAITING</b>
Locked hubcaps?.....	<input type="checkbox"/> YES	<input type="checkbox"/> NO	
If yes, where is the key?.....			
Aluminum wheels?.....	<input type="checkbox"/> YES	<input type="checkbox"/> NO	
Do you need an oil change?.....	<input type="checkbox"/> YES	<input type="checkbox"/> NO	<input type="checkbox"/> Call with estimate _____
			<input type="checkbox"/> Will call _____

PLEASE PERFORM THE FOLLOWING:

Brake Inspection _____	Exhaust Inspection _____	Suspension Inspection _____	Maintenance Inspection _____
Oil & Lube Service _____	Air Conditioning Inspection _____	Other _____	



MIDAS AUTO SERVICE EXPERTS

EXHAUST, SUSPENSION,  
MAINTENANCE  
INSPECTION REPORT

No. C 2452573

YEAR <i>88</i>	MAKE <i>Chev</i>	MODEL <i>Suburban</i>	CSR NO.	LICENSE NO. & STATE/PROVINCE
----------------	------------------	-----------------------	---------	------------------------------

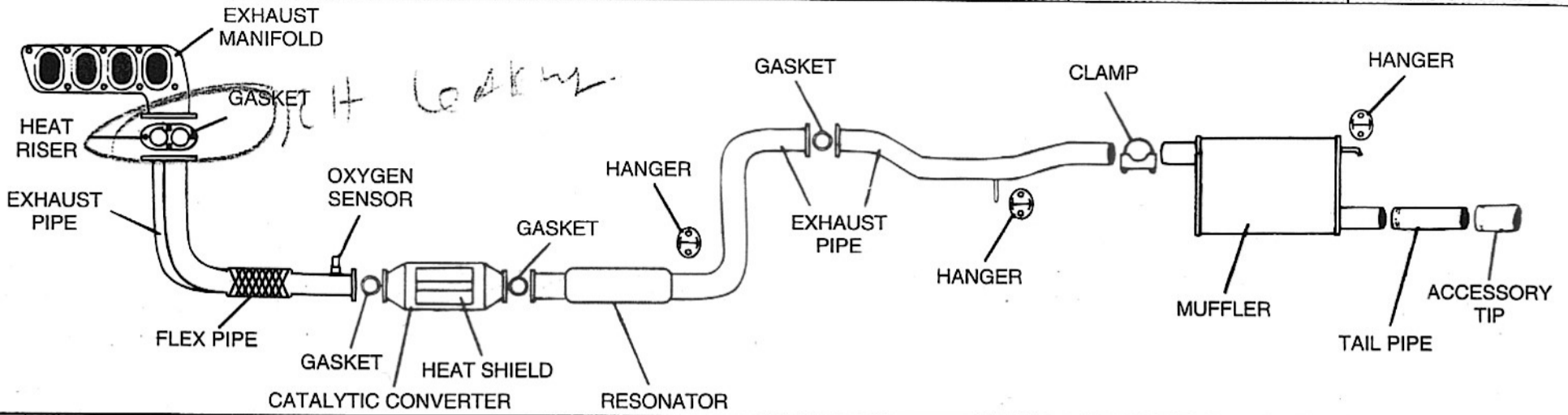

INSPECTED	OPTIONAL	REQUIRED	QUANTITY	INSPECTIONS														
				EXHAUST				SUSPENSION				MAINTENANCE						
				CODE	COMPONENT	CONDITION/LOCATION		CODE	COMPONENT	CONDITION/LOCATION		CODE	COMPONENT	CONDITION/LOCATION				
✓					Manifold						Wheel Nuts Studs				<b>OIL AND LUBE</b>			
					Heat Riser						Wheel Bearings						Oil Service Due	Mi/Km
					Studs/Bolts						Upper Ball Joints	R	Spec	Actual			Oil	
✓	✓				Gaskets/Flanges	<i>Leaking</i>					Lower Ball Joints	L	Spec	Actual			Oil Filter	
					O <sub>2</sub> Sensor						Chassis Height	R	Spec	Actual			Drain Plug Gasket	
					Check Valve						Inner Tie Rod End/Sleeve	R					Oil Pan Gasket	
					Catalytic Converter						Outer Tie Rod End/Sleeve	L					Transmission Pan Gasket	
					Air Tubes						Outer Tie Rod End/Sleeve	R					Grease Fittings	
					Exhaust Pipes						Springs/Torsion Bars						<b>FLUIDS</b>	
					Mufflers, Resonators						Shocks/Struts	LF					Engine Coolant	
					Tail Pipes						Shocks/Struts	RF					Brake	
					Accessory Tips						Shocks/Struts	LR					Windshield Washer	
					Hangers						Strut Bearing Plate	RR					Power Steering	
					Clamps						CV Joint Half Shaft Boot	R					Transmission	
					Engine/Trans Mounts						U-Joint	L					Transfer Case	
											Power Steering Pump						Differential	
											Power Steering Hoses						<b>MAINTENANCE</b>	
											Bushings						Dash Warning Lights	
											Sway Bar Link						Horn	
											Steering Gear Rack						Wiper Blades/Arms	
											Pitman Arm Idler Arm						Exterior Lamps	
											Steering Damper						Drive Belts	
											Tires						Power Steering	
																	Pulleys/Tensioner	
																	Air Filter/Breather	
																	PCV Valve	
																	Hoses	
																	Fuel Filter	
																	Battery	
																	Starter	
																	Alternator	

**SUGGESTED SERVICES**

**WHY?**

- Alignment Check
- Rotate Tires
- Wheel Balance
- Brake Inspection
- Manufacturer's Scheduled Maintenance
- Fuel system service

Technician Notes: \_\_\_\_\_

TECHNICIAN SIGNATURE

*CD*

TECHNICIAN NO.

MGR.

*DE*



The West's Largest Independent Tire Dealer

228420

SOLD TO: REX VAN NOY 542-8070

LES SCHWAB TIRE CENTER  
 1914 Mendocino Ave  
 Santa Rosa, CA 95401 3631  
 707-541-7332 BAR# AC238352

ACCT 655 99998 INVOICE 10089

DATE 06-29-2005 TIME 9:38:11

SOLD BY	TRANSACTION TYPE	WORK ORDER #	CUSTOMER PO #	LICENSE	MILEAGE	YEAR / MAKE / MODEL
JC	CASH	870				1988 GMC TRUCK R+V 1500-3500 PU,SUB

QTY.	PRODUCT CODE	PRODUCT DESCRIPTION	PRICE	FET	AMOUNT
		All Parts New Unless Specified			
1	57280220	51-7522 REMANUFACTURED ST. GEAR	235.91		235.9
1	00680350	STEERING GEARS INSTALLATION	84.50		84.5
1	00680112	THRUST ANGLE ALIGNMENT - DOMESTIC/IMPORT CARS, PICKUPS, VANS	45.95		45.9
		Paid By: VISA CARD	385.23		
		XXXXXXXXXXXX5946	057984		
		PREPAID SPECIAL ORDER			
		Parts: 235.91 Labor: 130.45			

**NOTICE: The following conditions apply to all sales except where Seller issues a written warranty.**  
 SELLER ASSIGNS TO PURCHASER ALL RIGHTS AND REMEDIES UNDER MFRS. EXPRESS AND IMPLIED WARRANTIES, BUT OTHERWISE EXCLUDES ALL LIABILITY FOR WARRANTY DAMAGES. SPECIAL AND CONSEQUENTIAL DAMAGES FOR LES SCHWAB MFRD. PRODUCTS EXCLUDED TO EXTENT LAW ALLOWS. ALL CLAIMS AND RETURNED GOODS MUST BE ACCOMPANIED BY THIS INVOICE.  
 Purchaser acknowledges having received the goods described above and having read and received a copy of the Security Agreement and Warning (when applicable) contained on the reverse side hereof.

SALES TAX	18.8
TIRE TAX	.0
<b>TOTAL</b>	<b>385.2</b>

PURCHASER X

CUSTOMER COPY

Tires **LES SCHWAB**



# Alignment and Automotive Parts

716679

## SERVICE & WARRANTY CONTRACT (This is a Limited Warranty)

The alignment, automotive parts and service listed on the attached invoice is covered by the **LES SCHWAB SERVICE AND WARRANTY CONTRACT**, and will be given service or remedied under this warranty upon bringing the vehicle and presenting this contract with invoice attached to any Les Schwab Tire Center with under car service listed on the reverse side of this warranty.

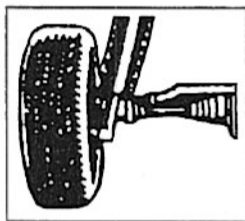

**ALIGNMENT SERVICE**

Les Schwab complete alignment service includes setting caster, camber and toe to individual vehicle specifications when factory adjustable. Les Schwab warrants our alignment for a period of 30 days. Should incorrect alignment be detected within this 30 day period, Les Schwab will re-align your vehicle to specifications free of charge.

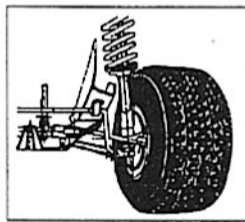

**ALIGNMENT AND CHASSIS PARTS**

The alignment and chassis parts listed on the attached invoice when sold and installed by Les Schwab, are covered by this warranty for a period of 12 months. Parts that fail during this time period due to defects in materials or workmanship and show no signs of service neglect or abuse will be replaced absolutely free of charge. Mis-alignment or damage caused by abuse or collision is excluded.

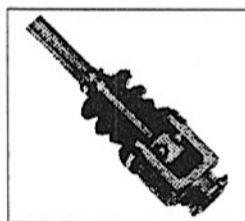

**COMPLETE FWD DRIVE AXLE SHAFT REPLACEMENT**

Les Schwab warrants complete FWD Drive Axle Shaft Replacement for a period of 25,000 miles or 36 months, whichever comes first from date of purchase. Should a failure in materials or workmanship occur during this period of time, Les Schwab will replace the defective parts and labor absolutely free. Single CV joint and boot replacement are covered by this warranty for a period of 12 months.



**PERFORMANCE SUSPENSION SYSTEMS**

Les Schwab offers a one year warranty on our performance suspension systems (including lifting/lowering kits) to the original purchaser. Should a failure in parts or labor occur in this time period, the parts and labor will be replaced free of charge. This warranty does not cover parts that have been damaged due to service neglect, abuse or collision. Les Schwab requires you to return and have all your nuts and bolts retorqued to specifications within 100 miles after original installation.

**FREE INSPECTION ANYTIME:** Les Schwab reminds its customers once your vehicles alignment is set to specifications, increased tire mileage can be expected. To help insure correct alignment and tire mileage, Les Schwab will inspect for tire wear anytime during normal store hours free of charge upon customer request.

**CONSEQUENTIAL DAMAGES ARE EXCLUDED:** Les Schwab will not be responsible for any consequential damages arising out of alignment, automotive parts or service failure, except for injuries to the person. This service and warranty contract gives you specific rights, and you may also have other rights which vary from state to state. For instance, some states do not allow the exclusion or limitation of consequential damages, so the above exclusion may not apply to you.

This warranty contract is not valid unless accompanied by Invoice No.

OVER 380 LOCATIONS TO SERVE YOU IN OREGON-WASHINGTON-IDAHO-MONTANA-CALIFORNIA-NEVADA-UTAH-ALASKA  
Les Schwab Tire Centers P.O. Box 667 Prineville, Oregon 97754

**\* SHILOH  
\* AUTO  
\* REPAIR**

3-2-05

1244 CENTRAL AVENUE  
SANTA ROSA, CA 95401

PHONE: (707) 523-4242

E Mail: shilohauto@juno.com

Bar #ACI38098

**SERVICE ORDER**

<p><b>* DOMESTIC *</b> <b>* IMPORTS *</b> <b>* OIL CHANGES *</b> <b>* SMOG CHECK &amp; REPAIR *</b> <b>* COMPLETE AUTO REPAIR *</b> <b>* BRAKES *</b></p>		<p>CUSTOMER NAME &amp; ADDRESS Boring</p>		<p>DATE &amp; TIME 3/2/05</p>	<p>LABOR IS GUARANTEED FOR (WHICHEVER COMES FIRST) MILES: DAYS: DAILY STORAGE FEE AFTER 72 HOURS HOURLY LABOR RATE DIAGNOSTIC FEE ALL PARTS ARE NEW UNLESS SPECIFIED AS USED (U) OR REBUILT (R) NEW TIRE TAX \$1.00 EACH</p>
<p>VEHICLE LICENSE NO. ZJHY101</p>	<p>ODOMETER 39006</p>	<p>VEHICLE DESCRIPTION 88 Chev</p>	<p>VEHICLE IDENTIFICATION NO.</p>	<p>WRITTEN BY</p>	
<p>PAYMENT METHOD</p>		<p>CREDIT AUTHORIZATION</p>		<p>PROMISED</p>	
<p><b>SERVICE REPAIR INSTRUCTIONS / SYMPTOMS</b></p>					<p><input type="checkbox"/> DELIVER <input type="checkbox"/> WILL CALL <input type="checkbox"/> PHONE WHEN READY</p>
					<p>PREPARED BY</p>
					<p>CERTIFIED BY</p>

TECH.	QTY	PART NO.	REPAIR / SERVICE DESCRIPTION	PARTS	LABOR
			<p>Safety Inspr Cert</p>		<p>60.00 8.25</p>

<p>CUSTOMER REQUESTED RETURNED PARTS <input type="checkbox"/> YES <input type="checkbox"/> NO</p> <p>I, the registered owner, authorize you to perform the above repairs and furnish necessary materials. I understand any cost quoted heretofore is an estimate only. Your employees may operate vehicle for inspection, testing, delivery at my risk. You will not be responsible for loss or damage to vehicle or articles left in it. I agree to pay reasonable storage on vehicle left more than 48 hours after notification that repairs are completed. An express Mechanic's Lien is acknowledged on above vehicle to secure the amount of repairs thereto, including those from any prior work or repair contract on this vehicle. In the event an attorney is retained to foreclose this lien or to bring suit to collection of any sums due, I agree to pay costs of collection and any reasonable attorney fees. Receipt of a copy of this order is hereby acknowledged.</p> <p>CUSTOMER'S SIGNATURE X B. Van Noy</p> <p>Warranty repairs based on guaranteed labor for this invoice must be performed at this location.</p>	<p><b>SAFETY RECOMMENDATIONS</b></p>	<p><b>TOTALS</b></p> <p>LABOR 60.00</p> <p>PARTS</p> <p>SALE TAX</p> <p>GASOLINE Cert 8.25</p> <p>SUB-LET ( )</p> <p>DEPOSIT</p> <p><b>TOTAL 68.25</b></p>
---	--------------------------------------	--

Thank You!

<p>REVISSED ESTIMATE</p>	<p>PARTS BY</p>	<p>LABOR AUTHORIZED BY CUSTOMER</p>	<p>TOTAL</p>	<p>DATE</p>	<p>TIME</p>	<p>PHONE NO.</p>	<p>I ACKNOWLEDGE NOTICE AND ORAL APPROVAL OF AN INCREASE IN THE ORIGINAL ESTIMATED PRICE.</p>
--------------------------	-----------------	-------------------------------------	--------------	-------------	-------------	------------------	---



## Smog Check Vehicle Inspection Report (VIR) Vehicle Information

Test Date/Time: 03/02/2005 @ 08:51 AM	Make: CHEVROLET	Model: K20 SUBURBAN
Model-Year: 1988	State: CA	VIN: 1GNR26N3JF131139
License: 2JHY101	Type: TRUCK	Transmission: AUTOMATIC
Engine Size: 7.4L	Test Weight: 5250	Cylinders: 08
GVWR: 08600	Certification: CALIFORNIA	VLT Record #: 40615
Odometer: 039006	Exhaust: Single	Inspection Reason: Biennial Inspection
Fuel-Type: GASOLINE		

### Overall Test Results - PASS

Congratulations! Your vehicle passed the enhanced Smog Check inspection, which helps California reach its daily goal of removing an extra 100 tons of smog-forming emissions from the air. Thank you for keeping your vehicle well maintained.

Comprehensive Visual Inspection: PASS      Functional Check: PASS      Emissions Test: PASS

Smog Check Certificate Number: FS489777  
DMV ID Number: 3306S818F209

Your Smog Check certificate has been electronically transmitted to DMV.  
Your certificate is valid for 90 days from date of issuance.

Please keep this copy for your records.

### Emission Control Systems Visual Inspection/Functional Check Results

( Visual/Functional tests are used to assist in the identification of crankcase and cold start emissions which are not measured during the ASM test.)

<u>RESULT</u>	<u>ECS</u>	<u>RESULT</u>	<u>ECS</u>	<u>RESULT</u>	<u>ECS</u>
PASS	PCV	PASS	Thermostatic Air Cleaner	PASS	Fuel Evaporative Controls
PASS	Catalytic Converter	PASS	Air Injection	PASS	Oxygen Sensor
PASS	Exhaust Gas Recirculation	NOT APPL	Spark Controls	PASS	Carb./Fuel Injection
PASS	Wiring to Sensors	PASS	Vacuum Lines to Sensors/Switches	PASS	Other Emission Related Components
PASS	Fuel Cap Visual Test	PASS	Ignition Timing: B06	PASS	System Malfunction Light
PASS	Fuel Cap Functional Test	NOT APPL	EGR Functional Test	PASS	Liquid Fuel Leaks
NOT APPL	Fuel EVAP Test				

### ASM Emission Test Results

Test	RPM	%CO2		HC (PPM)			CO (%)			NO (PPM)			Results
		MEAS	MEAS	MAX	AVE	MEAS	MAX	AVE	MEAS	MAX	AVE	MEAS	
15 mph	1416	14.86	0.19	134	62	24	1.34	0.18	0.08	2213	437	0104	PASS
25 mph	1400	14.82	0.12	107	45	13	1.60	0.12	0.03	2163	338	0119	PASS

MAX=Maximum Allowable Emissions

AVE=Average Emissions For Passing Vehicles

MEAS=Amount measured

### Smog Check Inspection Station Information

SHILOH AUTO REPAIR 1244 CENTRAL AVE. SANTA ROSA, CA 95401-0000 (707) 523-4242	Station Number: RC138098	Technician Name/Number: WOFFORD PERRY LEE /EA095929 Repair Tech Name/Number: N/A Software Version/EIS Number: 0306/S0400800
--	--------------------------	---

I certify, under penalty of perjury under the laws of the State of California, that I inspected the vehicle described above, that I performed the inspection in accordance with all bureau requirements, and that the information listed on this vehicle inspection report is true and correct.

\_\_\_\_\_  
Date

\_\_\_\_\_  
Technician's Signature

# \* SHILOH \* AUTO \* REPAIR

1244 CENTRAL AVENUE  
SANTA ROSA, CA 95401

PHONE: (707) 523-4242

E Mail: shilohauto@juno.com

Bar #ACI38098

02/04 10:55 AM

## SERVICE ORDER # 15721

<p>* DOMESTIC * * IMPORTS * * OIL CHANGES * * SMOG CHECK &amp; REPAIR * * COMPLETE AUTO REPAIR * * BRAKES *</p>		<p>CUSTOMER NAME &amp; ADDRESS SANTA ROSA, CA. 95409</p>		<p>DATE &amp; TIME 07/02/04</p>	<p>LABOR IS GUARANTEED FOR (WHICHEVER COMES FIRST) MILES: 4000 DAYS: 90</p>
<p>VEHICLE LICENSE NO. 2JHY101</p>	<p>ODOMETER 35965 / 35965</p>	<p>VEHICLE DESCRIPTION 1998 Chevrolet Subar</p>	<p>VEHICLE IDENTIFICATION NO. 1GN9R28N3JF131139</p>	<p>WRITTEN BY</p>	<p>DAILY STORAGE FEE AFTER 72 HOURS 20.00</p>
<p>PAYMENT METHOD Ck</p>		<p>CREDIT AUTHORIZATION A</p>		<p>PROMISED 07/02/04</p>	<p>HOURLY LABOR RATE 95.00</p>
<p><b>SERVICE REPAIR INSTRUCTIONS / SYMPTOMS</b></p>				<p><input type="checkbox"/> DELIVER <input type="checkbox"/> WILL CALL <input type="checkbox"/> PHONE WHEN READY</p>	<p>DIAGNOSTIC FEE 150.00</p>
				<p>PREPARED BY</p>	<p>ALL PARTS ARE NEW UNLESS SPECIFIED AS USED (U) OR REBUILT (R)</p>
				<p>CERTIFIED BY</p>	<p>NEW TIRE TAX \$1.00 EACH 0.00</p>

TECH.	QTY	PART NO.	REPAIR / SERVICE DESCRIPTION	PARTS	LABOR
	1.0		R&R FRONT SHOCKS		42.50
	2.00	KYB KG5409	GAS-A-JUST SHOCK	171.95	



CUSTOMER REQUESTED RETURNED PARTS  YES  NO

I, the registered owner, authorize you to perform the above repairs and furnish necessary materials. I understand any cost quoted heretofore is an estimate only. Your employees may operate vehicle for inspection, testing, delivery at my risk. You will not be responsible for loss or damage to vehicle or articles left in it. I agree to pay reasonable storage on vehicle left more than 48 hours after notification that repairs are completed. An express Mechanic's Lien is acknowledged on above vehicle to secure the amount of repairs thereto, including those from any prior work or repair contract on this vehicle. In the event an attorney is retained to foreclose this lien or to bring suit to collection of any sums due, I agree to pay costs of collection and any reasonable attorney fees. Receipt of a copy of this order is hereby acknowledged.

CUSTOMER'S SIGNATURE  
*[Signature]*

Warranty repairs based on guaranteed labor for this invoice must be performed at this location.

**SAFETY RECOMMENDATIONS**

*Thank You!*

TOTALS	
LABOR	
PARTS	
SALE TAX	
GASOLINE	
	42.50
SUB-LET	( 171.95)
DEPOSIT	12.90
<b>TOTAL</b>	

REVISSED ESTIMATE	PARTS	LABOR	TOTAL	DATE	TIME	I ACKNOWLEDGE NOTICE AND ORAL APPROVAL OF AN INCREASE IN THE ORIGINAL ESTIMATED PRICE.
BY	AUTHORIZED BY CUSTOMER		PHONE NO.			

0.00  
0.00

# \* SHILOH \* AUTO \* REPAIR

1244 CENTRAL AVENUE  
SANTA ROSA, CA 95401

PHONE: (707) 523-4242

E Mail: shilohauto@juno.com

Bar #ACI38098

02/04 11:12 AM

## SERVICE ORDER PRICE 15721

<p><b>* DOMESTIC *</b> <b>* IMPORTS *</b> <b>* OIL CHANGES *</b> <b>* SMOG CHECK &amp; REPAIR *</b> <b>* COMPLETE AUTO REPAIR *</b> <b>* BRAKES *</b></p>		<p>CUSTOMER NAME &amp; ADDRESS</p> <p>SANTA ROSA, CA. 95409</p>		<p>DATE &amp; TIME</p> <p>07/02/04</p>	<p>LABOR IS GUARANTEED FOR (WHICHEVER COMES FIRST)</p> <p>MILES: 4000</p> <p>DAYS: 90</p>
<p>VEHICLE LICENSE NO. 2JHY1D1</p> <p>ODOMETER 55365 / 55365</p> <p>VEHICLE DESCRIPTION 1985 Chevrolet Subar</p> <p>VEHICLE IDENTIFICATION NO. 1GNCR28N3JF131199</p>		<p>PAYMENT METHOD CK4520</p> <p>CREDIT AUTHORIZATION 4</p>		<p>WRITTEN BY</p> <p>PROMISED 07/02/04</p> <p>DELIVER <input type="checkbox"/></p> <p>WILL CALL <input type="checkbox"/></p> <p>PHONE WHEN READY <input type="checkbox"/></p>	<p>DAILY STORAGE FEE AFTER 72 HOURS 20.00</p> <p>HOURLY LABOR RATE 95.00</p> <p>DIAGNOSTIC FEE 150.00</p> <p>ALL PARTS ARE NEW UNLESS SPECIFIED AS USED (U) OR REBUILT (R)</p> <p>NEW TIRE TAX \$1.00 EACH 0.00</p>
<b>SERVICE REPAIR INSTRUCTIONS / SYMPTOMS</b>					
<p>PREPARED BY</p> <p>CERTIFIED BY</p>					

TECH.	QTY	PART NO.	REPAIR / SERVICE DESCRIPTION	PARTS	LABOR
	1.0		R&R FRONT SHOCKS		42.50
	2.00	KYB KG5409	GAS-A-JUST SHOCK	171.98	
	1.0		ADJUST STEERING BOX		25.50

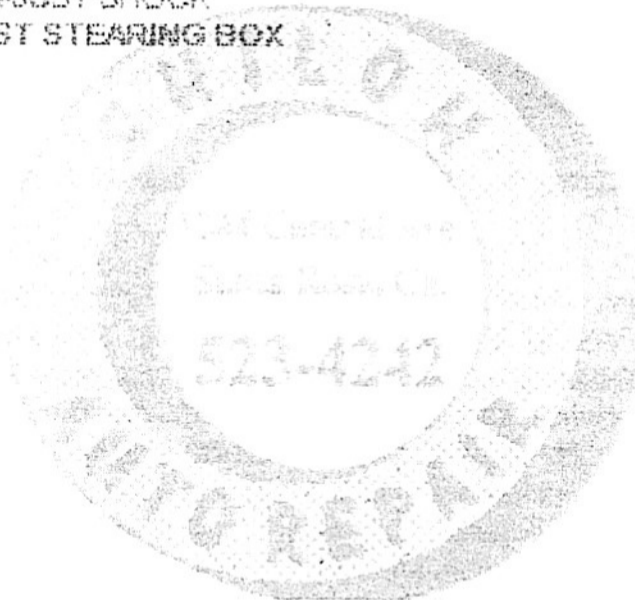

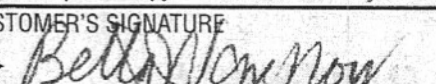
<p>CUSTOMER REQUESTED RETURNED PARTS <input type="checkbox"/> YES <input type="checkbox"/> NO</p> <p>I, the registered owner, authorize you to perform the above repairs and furnish necessary materials. I understand any cost quoted heretofore is an estimate only. Your employees may operate vehicle for inspection, testing, delivery at my risk. You will not be responsible for loss or damage to vehicle or articles left in it. I agree to pay reasonable storage on vehicle left more than 48 hours after notification that repairs are completed. An express Mechanic's Lien is acknowledged on above vehicle to secure the amount of repairs thereto, including those from any prior work or repair contract on this vehicle. In the event an attorney is retained to foreclose this lien or to bring suit to collection of any sums due, I agree to pay costs of collection and any reasonable attorney fees. Receipt of a copy of this order is hereby acknowledged.</p> <p>CUSTOMER'S SIGNATURE  </p> <p>Warranty repairs based on guaranteed labor for this invoice must be performed at this location.</p>		<p><b>SAFETY RECOMMENDATIONS</b></p>		<p><b>TOTALS</b></p> <p>LABOR</p> <p>PARTS</p> <p>SALE TAX</p> <p>GASOLINE 68.00</p> <p>SUB-LET ( 171.98)</p> <p>DEPOSIT 12.90</p> <p><b>TOTAL</b></p>	
<p>REVISOR</p> <p>ESTIMATE BY</p>	<p>PARTS</p> <p>LABOR</p> <p>TOTAL</p> <p>AUTHORIZED BY CUSTOMER</p>	<p>DATE</p> <p>TIME</p> <p>PHONE NO.</p>	<p>I ACKNOWLEDGE NOTICE AND ORAL APPROVAL OF AN INCREASE IN THE ORIGINAL ESTIMATED PRICE.</p> <p style="text-align: right;">0.00 0.00</p>		

*Thank You!*

# NORTH BAY RADIATOR & A/C

1239 CLEVELAND AVE.  
SANTA ROSA, CA 95401  
B.A.R.# AM 202811  
707-542-5778

INVOICE #

12845

DATE

8/3/2004

## INVOICE

BILL TO

CASH CUSTOMER

88 CHEVY SUBURBAN 454  
ENGINE

P.O.#/MILE...

37445.2

TERMS

CASH

LICENSE #

2JHY101

DESCRIPTION	QTY	RATE	AMOUNT
RADIATOR RODOUT/CLEAN/REPAIR	1	100.00	100.00
WASTE ANTIFREEZE DISPOSAL	1	8.00	8.00
ANTI-FREEZE/COOLANT	2	12.00	24.00T
REMOVE & REPLACE RADIATOR	1	110.00	110.00
NEW UPPER-LOWER RADIATOR HOSES	2	28.00	56.00T
HOSE CLAMPS	4	1.50	6.00T
SALES TAX		7.50%	6.45

AUTHORIZED BY;

# \_\_\_\_\_

Thank you for your business.

Total

\$310.45

CUSTOMER INFORMATION		TAG #	VEHICLE INFORMATION		YEAR / MAKE / MODEL	INITIAL ESTIMATE	REVISED ESTIMATE	CREATED BY	
NAME: ADDRESS: CITY/ST/ZIP: HOME PHONE:			LICENSE #	COLOR		PARTS			
STORE IN:			38890	WHITE BLUE		LABOR			
6718 - SEARS 98 Santa Rosa Plaza Santa Rosa, CA 95401 (707) 571-5628			131139	INCOMETER OUT		OTHER \$49.17		INVOICED BY 517193	
WAITING EPA Number: Repair Number: AF022606		PROMISED TIME	TIRE INSTALLATION INSTRUCTIONS		LOCKS	TAX \$12.99	DATE/TIME OF ESTIMATE 10/01/2007 11:21 AM	DATE/TIME OF REVISED	PAYMENT TYPE
REFERENCE NUMBER NO YES		PRINTED ON 10/01/2007 12:01 PM	<input type="checkbox"/> LF <input type="checkbox"/> RF <input type="checkbox"/> SP <input type="checkbox"/> BW <input type="checkbox"/> WW <input type="checkbox"/> LR <input type="checkbox"/> RR <input type="checkbox"/> ROWL		<input type="checkbox"/> Y <input type="checkbox"/> N	TOTAL \$66.09			CASH <input type="checkbox"/> CREDIT <input type="checkbox"/> CHECK <input type="checkbox"/>
CUSTOMER COMMENTS WD4462350 LFP# 482350 REPLACE BATTERY #4912559 8-26-03		10/01/2007 11:21 AM	AIR PRESSURE FRONT / REAR						See reverse for important warranty terms and other information.
			WHL. TORQUE SPECIFICATION REFER TO TIRE GUIDE						CUSTOMER WORK AUTHORIZATION <i>Betty W...</i>

QTY.	ITEM #	DESCRIPTION OF MERCHANDISE	PRICE EA.	EXTENSION	TECH.
1	PS 22833078	DIENARD, GOLD GRP 78	\$99.99	\$99.99	ASSOC. 517193
1	AC 082027	CORE VALUE TAX	\$0.80	\$0.80	517193
1	LB 19021010	DIENARD, SERVICE BATTERY	\$12.99	\$12.99	517193
1	RT 22833078	BATTERY ADJUSTMENT	-\$50.82	-\$50.82	517193
1	RT 082027	CORE VALUE TAX	-\$0.80	-\$0.80	517193

**See reverse for important warranty terms and other information.**

CUSTOMER WORK AUTHORIZATION  
*Betty W...*

This is a WORKORDER, with your authorization we will perform the services you have approved. Thank you for the opportunity to serve you.

This is a WORKORDER, with your authorization we will perform the services you have approved. Thank you for the opportunity to serve you.

This is a WORKORDER, with your authorization we will perform the services you have approved. Thank you for the opportunity to serve you.

This is a WORKORDER, with your authorization we will perform the services you have approved. Thank you for the opportunity to serve you.

A 15% Restocking Fee may apply on returned merchandise  
A 15% Cancellation Fee may apply on Special Ordered merchandise cancelled after 24 hours  
See Salesperson for details

RETURN OLD PARTS TO CUSTOMER  Y  N

ALL NEW, NON-OEM PARTS UNLESS OTHERWISE SPECIFIED.

ITEM / WARRANTY INFORMATION / CSA COMMENTS / TECHNICIAN COMMENTS

Aftermarket TPMS Available. Verify TPMS.  
WARRANTY:  
22833078 : 36 Months Full Replacement Warranty - 100 Months Prorated Warranty

ALL LUG NUTS ON CUSTOM AND ALLOY WHEELS MUST BE RE-TORQUED AFTER 25 MILES AND CHECKED PERIODICALLY.

ITEM COMMENTS:  
22833078: Designed for your climate. CCA's and RC's are determined in accordance with Industry Standards at time of manufacture. BATTERIES INCLUDE A CORE VALUE AND ARE ASSESSED TAX BASED ON STATE REQUIREMENTS. 795CCA - RESERVE MIN. = 110 - AUXILIARY GROUP 78 BATTERY RATED 540A - DEM AMPS: 630 - BCI GROUP: 78 - 100 MO WET BATTERY  
19021010: STARTING AND CHARGING SERVICE: ADJUST BELTS IF REQUIRED, STARTING & CHARGING SYSTEMS TEST, CORROSION PROTECTION, CLEAN CABLE ENDS, TRAY IF REQUIRED. INCLUDES R&R OF BATTERY IF NEEDED.

**Thank you for the opportunity to serve you.**  
Our goal is to provide Fast, Expert Service.  
Please keep us in mind for your future automotive needs.

# \* SHILOH \* AUTO \* REPAIR

1244 CENTRAL AVENUE  
SANTA ROSA, CA 95401

PHONE: (707) 523-4242

E Mail: shilohauto@juno.com

Bar #ACI38098

Page 1

## SERVICE ORDER

14443

<p>* DOMESTIC * * IMPORTS * * OIL CHANGES * * SMOG CHECK &amp; REPAIR * * COMPLETE AUTO REPAIR * * BRAKES *</p>		<p>CUSTOMER NAME &amp; ADDRESS 39 AL... E SANTA ROSA, CA. 95409</p>		<p>DATE &amp; TIME 10:28 AM 03/12/2003</p>	<p>LABOR IS GUARANTEED FOR (WHICHEVER COMES FIRST) MILES: 2000 DAYS: 180</p>
<p>VEHICLE LICENSE NO. 2JHY101 ODOMETER 31712 VEHICLE DESCRIPTION 1988 Chevrolet Suburb VEHICLE IDENTIFICATION NO. 1GNER26N3JF131139</p>		<p>PAYMENT METHOD <i>CA SH</i> CREDIT AUTHORIZATION</p>		<p>WRITTEN BY PROMISED 03/10/2003</p>	<p>DAILY STORAGE FEE AFTER 72 HOURS 19.00 HOURLY LABOR RATE 85.00 DIAGNOSTIC FEE 85.00 ALL PARTS ARE NEW UNLESS SPECIFIED AS USED (U) OR REBUILT (R) NEW TIRE TAX \$1.00 EACH</p>
<p><b>SERVICE REPAIR INSTRUCTIONS / SYMPTOMS</b></p> <p>CHARGING SYSTEM TEST</p>					

TECH.	QTY	PART NO.	REPAIR / SERVICE DESCRIPTION	PARTS	LABOR
			TEST CHARGING SYSTEM		42.50
			CHARGE BATTERY, TEST CHARGING SYSTEM. NEEDS ALT. REPAIRED RR SPRING KEEPER		75.00
	1	BOLT	BOLT	1.89	
	1	7802N	REPLACE ALTERNATOR 7802N ALTERNATOR	210.11	75.00

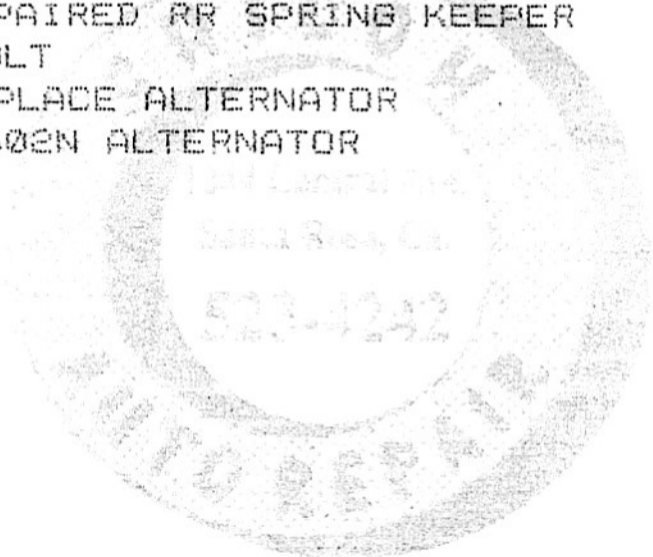

<p>CUSTOMER REQUESTED RETURNED PARTS <input type="checkbox"/> YES <input type="checkbox"/> NO</p> <p>I, the registered owner, authorize you to perform the above repairs and furnish necessary materials. I understand any cost quoted heretofore is an estimate only. Your employees may operate vehicle for inspection, testing, delivery at my risk. You will not be responsible for loss or damage to vehicle or articles left in it. I agree to pay reasonable storage on vehicle left more than 48 hours after notification that repairs are completed. An express Mechanic's Lien is acknowledged on above vehicle to secure the amount of repairs thereto, including those from any prior work or repair contract on this vehicle. In the event an attorney is retained to foreclose this lien or to bring suit to collection of any sums due, I agree to pay costs of collection and any reasonable attorney fees. Receipt of a copy of this order is hereby acknowledged.</p>		<p><b>SAFETY RECOMMENDATIONS</b></p>		<p><b>TOTALS</b></p>	
<p>CUSTOMER'S SIGNATURE <i>[Signature]</i></p>		<p>LABOR 192.50 PARTS 212.00 SALE TAX 15.90 GASOLINE SUB-LET ( ) DEPOSIT</p>		<p><b>TOTAL 420.40</b></p>	
<p>Warranty repairs based on guaranteed labor for this invoice must be performed at this location.</p>		<p>REVISSED ESTIMATE BY</p>		<p>LABOR 192.50 PARTS 212.00 TOTAL 404.50</p>	
<p>DATE 03/11/03 TIME 1:32 PM</p>		<p>PHONE NO. 542-0070</p>		<p>I ACKNOWLEDGE NOTICE AND ORAL APPROVAL OF AN INCREASE IN THE ORIGINAL ESTIMATED PRICE.</p>	

*Thank You!*

**\* SHILOH  
\* AUTO  
\* REPAIR**

1244 CENTRAL AVENUE  
SANTA ROSA, CA 95401

PHONE: (707) 523-4242

E Mail: shilohauto@juno.com

Bar #AC138098

**SERVICE ORDER**

14470

Page 1

<p><b>* DOMESTIC *</b> <b>* IMPORTS *</b> <b>* OIL CHANGES *</b> <b>* SMOG CHECK &amp; REPAIR *</b> <b>* COMPLETE AUTO REPAIR *</b> <b>* BRAKES *</b></p>		<p>CUSTOMER NAME &amp; ADDRESS VAN NOY E SANTA ROSA, CA. 95409 (7...) (7...)</p>		<p>DATE &amp; TIME 11:42 AM 03/17/2003</p>	<p>LABOR IS GUARANTEED FOR (WHICHEVER COMES FIRST) MILES: 2000 DAYS: 180</p>
<p>VEHICLE LICENSE NO. 2JHY101 ODOMETER 31722 VEHICLE DESCRIPTION 1988 Chevrolet Suburb VEHICLE IDENTIFICATION NO. 1GNBR26N3JF131139</p>		<p>PAYMENT METHOD CASH # 4046 CREDIT AUTHORIZATION</p>		<p>WRITTEN BY PROMISED 03/17/2003</p>	<p>DAILY STORAGE FEE AFTER 72 HOURS 19.00 HOURLY LABOR RATE 85.00 DIAGNOSTIC FEE 85.00</p>
<p><b>SERVICE REPAIR INSTRUCTIONS / SYMPTOMS</b></p> <p>SMOG</p>				<p><input type="checkbox"/> DELIVER <input type="checkbox"/> WILL CALL <input type="checkbox"/> PHONE WHEN READY</p>	<p>ALL PARTS ARE NEW UNLESS SPECIFIED AS USED (U) OR REBUILT (R) NEW TIRE TAX \$1.00 EACH</p>

TECH.	QTY	PART NO.	REPAIR / SERVICE DESCRIPTION	PARTS	LABOR
	1	SMOG DE	SMOG INSPECTION CUSTOMER DECLINES PRE T SMOG CERTIFICATE	8.25	60.00



<p>CUSTOMER REQUESTED RETURNED PARTS <input type="checkbox"/> YES <input type="checkbox"/> NO</p> <p>I, the registered owner, authorize you to perform the above repairs and furnish necessary materials. I understand any cost quoted heretofore is an estimate only. Your employees may operate vehicle for inspection, testing, delivery at my risk. You will not be responsible for loss or damage to vehicle or articles left in it. I agree to pay reasonable storage on vehicle left more than 48 hours after notification that repairs are completed. An express Mechanic's Lien is acknowledged on above vehicle to secure the amount of repairs thereto, including those from any prior work or repair contract on this vehicle. In the event an attorney is retained to foreclose this lien or to bring suit to collection of any sums due, I agree to pay costs of collection and any reasonable attorney fees. Receipt of a copy of this order is hereby acknowledged.</p>		<p><b>SAFETY RECOMMENDATIONS</b></p>		<p><b>TOTALS</b></p>	
<p>CUSTOMER'S SIGNATURE X Byron Noy</p> <p>Warranty repairs based on guaranteed labor for this invoice must be performed at this location.</p>		<p>LABOR 60.00 PARTS 8.25 SALE TAX 0.00 GASOLINE STATE CERT. 8.25 SUB-LET ( ) DEPOSIT ( )</p>		<p><b>TOTAL 68.25</b></p>	
<p>REVISED ESTIMATE BY</p>	<p>PARTS 8.25 LABOR 60.00 TOTAL 68.25</p>	<p>DATE 03/17/03 TIME 11:05 AM</p>	<p>I ACKNOWLEDGE NOTICE AND ORAL APPROVAL OF AN INCREASE IN THE ORIGINAL ESTIMATED PRICE.</p>	<p>Thank You!</p>	
<p>AUTHORIZED BY CUSTOMER VAN NOY</p>		<p>PHONE NO. 542-8070</p>	<p>➔</p>		

**NORTH BAY AUTO CENTER**

BAR #: AK201859

EPA# CAL 000205358

440 DUTTON AVE #3

SANTA ROSA, CA 95407

Phone: (707) 578-0200 FAX: 523-0206

*Leaf Springs*  
Invoice No.  
**120418004**

Order Date 04/18/02 08:26 am Page 1  
Paid: 05/08/02 03:22 pm

Y  
SANTA ROSA CA 95409  
Hm:  
Wk: 9

**88 CHEVROLET SUBURBAN**  
Mileage in:28289 out:28289  
Lic: 2JHY101 Cyl Eng  
Vin:  
Equipment:  
Profile:

Quotes  
1 04/18/02 11:14am 960.00  
BETTY in person.

**Job01 CHECK AND ADVISE REAR SHOCKS Labor: \$0.00**

CHECK AND ADVISE REAR SHOCKS. LEFT REAR IS HANGING LOW.

VEHICLE NEEDS REAR LEAF SPRINGS. ESTIMATED COST OF REAR LEAF SPRINGS REPLACEMENT IS \$960.00 PARTS AND LABOR.

REAR SHOCKS ARE FINE AT THIS TIME.

Status: Completed Tech: GARY

Job Subtotal: \$0.00

**Job02 R&R REAR LEAF SPRINGS Labor: \$400.00**

REMOVE AND REPLACE REAR LEAF SPRINGS

22-547 LEAF SPRINGS-S 2.0 @ 280.00 =\$ 560.00 560.00

Status: Completed Tech: GARY

Job Subtotal: \$960.00

All parts are new unless stated.

ALL REPAIRS ARE WARRANTED FOR 12 MONTHS OR 12,000 MILES, WHICHEVER OCCURS FIRST, UNLESS OTHERWISE STATED IN WRITING ON THIS REPAIR ORDER. THIS IS A NATION WIDE WARRANTY GOOD AT ANY NAPA AUTO CARE CENTER.

IF YOU ARE WITHIN TWENTY FIVE (25) MILES OF THIS REPAIR FACILITY YOU MUST RETURN HERE FOR WARRANTY REPAIRS. IF YOU ARE BEYOND TWENTY FIVE (25) MILES YOU MUST CALL 1-800-452-NAPA TO AUTHORIZE REPAIRS.

I HEREBY ACKNOWLEDGE THAT I HAVE RECEIVED A COPY OF THE WARRANTY AND UNDERSTAND THE TERMS AND CONDITIONS OF THE WARRANTY.



NORTH BAY AUTO CENTER

BAR #: AK201859

EPA# CAL 000205358

440 DUTTON AVE #3

SANTA ROSA, CA 95407

Phone: (707) 578-0200 FAX: 523-0206

Invoice No.

120418004

Page 2

Order Date 04/18/02 08:26 am

Paid: 05/08/02 03:22 pm

CUSTOMER SIGNATURE \_\_\_\_\_

ALL ESTIMATES INCLUDE A \$3.75 CHARGE FOR HAZARDOUS WASTE DISPOSAL FEE. IF THERE ARE NO HAZARDOUS MATERIALS ASSOCIATED WITH THIS REPAIR THEN THIS FEE WILL BE REMOVED FROM THE FINAL INVOICE.

N=New, U=Used, R=Rebuilt

NO WARRANTY ON CUSTOMER SUPPLIED PARTS. LABOR WARRANTY APPLIES ONLY TO REPAIRS DONE AT THIS SHOP. LABOR WARRANTY DOES NOT APPLY UNLESS REPAIRS ARE DONE AT THIS SHOP. WARRANTY DOES NOT INCLUDE TOWING OR RENTAL VEHICLE.

All Parts are new unless otherwise stated.

Payments to NORTH BAY AUTO CENTER		Cost Summary	
Status: Paid Work Order		Labor	400.00
		Parts	560.00
Payments: \$1,005.75		HAZARDIOUS WASTE	3.75
1 4/18/02 560.00 Check		Subtotal	963.75
2 5/8/02 445.75 Check		Tax	42.00
		Total	\$1,005.75
		Payments	1,005.75
		Bal Due	0.00

Thank you for choosing NORTH BAY AUTO CENTER

# \* SHILOH \* AUTO \* REPAIR

1244 CENTRAL AVENUE  
SANTA ROSA, CA 95401

PHONE: (707) 523-4242

E Mail: shilohauto@juno.com

Bar #ACI38098

Page 1

## SERVICE ORDER

13617

<p>* DOMESTIC * * IMPORTS * * OIL CHANGES * * SMOG CHECK &amp; REPAIR * * COMPLETE AUTO REPAIR * * BRAKES *</p>		<p>CUSTOMER NAME &amp; ADDRESS SANTA ROSA, CA. 95409 (707) 523-4242</p>		<p>DATE &amp; TIME 2:34 PM 07/16/2002</p>	<p>LABOR IS GUARANTEED FOR (WHICHEVER COMES FIRST) MILES: 2000 DAYS: 100</p>
VEHICLE LICENSE NO. 2JHY101	ODOMETER 127196	VEHICLE DESCRIPTION 1988 Chevrolet Suburb	VEHICLE IDENTIFICATION NO.	WRITTEN BY	DAILY STORAGE FEE AFTER 72 HOURS 19.00
PAYMENT METHOD CK 3773		CREDIT AUTHORIZATION		PROMISED 07/16/2002	HOURLY LABOR RATE 75.00
<p><b>SERVICE REPAIR INSTRUCTIONS / SYMPTOMS</b></p> <p>BRAKES</p>				<input type="checkbox"/> DELIVER <input type="checkbox"/> WILL CALL <input type="checkbox"/> PHONE WHEN READY	DIAGNOSTIC FEE 75.00
				PREPARED BY	ALL PARTS ARE NEW UNLESS SPECIFIED AS USED (U) OR REBUILT (R)
				CERTIFIED BY	NEW TIRE TAX \$1.00 EACH

TECH.	QTY	PART NO.	REPAIR / SERVICE DESCRIPTION	PARTS	LABOR
	1	MKD153FM	REPLACE FRONT BRAKE PADS MKD153FM	0.00	75.00
	1	PH1218	LUBE, OIL & FILTER OIL FILTER	6.03	20.00
	8	10W30	10W30 MOTOR OIL	20.00	
	1.2	GEAR OIL	GEAR OIL	6.83	
	3	HAZ	HAZARDOUS WASTE CHARGE	0.00	

<p>CUSTOMER REQUESTED RETURNED PARTS <input type="checkbox"/> YES <input type="checkbox"/> NO</p> <p>I, the registered owner, authorize you to perform the above repairs and furnish necessary materials. I understand any cost quoted heretofore is an estimate only. Your employees may operate vehicle for inspection, testing, delivery at my risk. You will not be responsible for loss or damage to vehicle or articles left in it. I agree to pay reasonable storage on vehicle left more than 48 hours after notification that repairs are completed. An express Mechanic's Lien is acknowledged on above vehicle to secure the amount of repairs thereto, including those from any prior work or repair contract on this vehicle. In the event an attorney is retained to foreclose this lien or to bring suit to collection of any sums due, I agree to pay costs of collection and any reasonable attorney fees. Receipt of a copy of this order is hereby acknowledged.</p>		<p><b>SAFETY RECOMMENDATIONS</b></p>		<p><b>TOTALS</b></p>	
<p>CUSTOMER'S SIGNATURE <i>Besta Van Noy</i></p>		<p>Warranty repairs based on guaranteed labor for this invoice must be performed at this location.</p>		LABOR	95.00
				PARTS	32.86
				SALE TAX	2.46
				GASOLINE	
				HAZ CHRG.	3.00
				SUB-LET	( )
				DEPOSIT	
				<b>TOTAL</b>	<b>133.32</b>
REVISSED ESTIMATE	PARTS 32.86	LABOR 95.00	TOTAL 130.86	DATE 07/16/02	TIME 2:34 PM
BY	AUTHORIZED BY CUSTOMER VAN NOY		PHONE NO. 542-8070	I ACKNOWLEDGE NOTICE AND ORAL APPROVAL OF AN INCREASE IN THE ORIGINAL ESTIMATED PRICE.	

Thank You!

**\* SHILOH  
\* AUTO  
\* REPAIR**

1244 CENTRAL AVENUE  
SANTA ROSA, CA 95401  
**BAR ARD #AC138098**

PHONE: (707) 523-4242

E Mail: shilohauto@juno.com

Page 1

**SERVICE ORDER**

11112

<p><b>* DOMESTIC *</b> <b>* IMPORTS *</b> <b>* OIL CHANGES *</b> <b>* SMOG CHECK &amp; REPAIR *</b> <b>* COMPLETE AUTO REPAIR *</b> <b>* BRAKES *</b></p>		<p>CUSTOMER NAME &amp; ADDRESS                  VAN JOY                  39 _____ AVE                  SANTA ROSA, CA. 95409                  (707) _____ 39</p>		<p>DATE &amp; TIME                  1:18 PM                  02/20/2002</p>	<p>LABOR IS GUARANTEED FOR (WHICHEVER COMES FIRST)                  MILES: 2000                  DAYS: 150</p>
<p>VEHICLE LICENSE NO. 2JHY101</p>	<p>ODOMETER 127196</p>	<p>VEHICLE DESCRIPTION 1988 Chevrolet Suburb</p>	<p>VEHICLE IDENTIFICATION NO.</p>	<p>WRITTEN BY</p>	<p>DAILY STORAGE FEE AFTER 72 HOURS 19.00</p>
<p>PAYMENT METHOD                  CK 3625</p>			<p>CREDIT AUTHORIZATION</p>	<p>PROMISED 02/20/2002</p>	<p>HOURLY LABOR RATE 75.00</p>
<p><b>SERVICE REPAIR INSTRUCTIONS / SYMPTOMS</b>                  STALLING                  DIAGNOSTIC</p>				<p><input type="checkbox"/> DELIVER  <input type="checkbox"/> WILL CALL  <input type="checkbox"/> PHONE WHEN READY</p>	<p>DIAGNOSTIC FEE 75.00</p>
				<p>PREPARED BY</p>	<p>ALL PARTS ARE NEW UNLESS SPECIFIED AS USED (U) OR REBUILT (R)</p>
				<p>CERTIFIED BY</p>	<p>NEW TIRE TAX \$1.00 EACH</p>

TECH.	QTY	PART NO.	REPAIR / SERVICE DESCRIPTION	PARTS	LABOR
			DIAGNOSTIC-STALLS		37.50
			replace fuel filter		75.00
	1	BF481	FUEL FILTER	23.18	

<p>CUSTOMER REQUESTED RETURNED PARTS <input type="checkbox"/> YES <input type="checkbox"/> NO</p>		<p><b>SAFETY RECOMMENDATIONS</b></p>			<p><b>TOTALS</b></p>	
<p>I, the registered owner, authorize you to perform the above repairs and furnish necessary materials. I understand any cost quoted heretofore is an estimate only. Your employees may operate vehicle for inspection, testing, delivery at my risk. You will not be responsible for loss or damage to vehicle or articles left in it. I agree to pay reasonable storage on vehicle left more than 48 hours after notification that repairs are completed. An express Mechanic's Lien is acknowledged on above vehicle to secure the amount of repairs thereto, including those from any prior work or repair contract on this vehicle. In the event an attorney is retained to foreclose this lien or to bring suit for collection of any sums due, I agree to pay costs of collection and any reasonable attorney fees. Receipt of a copy of this order is hereby acknowledged.</p>					<p>LABOR 112.50</p>	<p>PARTS 23.18</p>
<p>CUSTOMER'S SIGNATURE                  Rex &amp; Betty Van Joy</p>					<p>SALE TAX 1.74</p>	<p>GASOLINE</p>
<p>Warranty repairs based on guaranteed labor for this invoice must be performed at this location.</p>					<p>SUB-LET ( )</p>	<p>DEPOSIT</p>
<p>REVISED ESTIMATE BY</p>					<p><b>TOTAL 137.42</b></p>	
<p>PARTS 23.18</p>		<p>LABOR 112.50</p>		<p>TOTAL 135.68</p>		
<p>DATE 02/20/02</p>		<p>TIME 1:18 PM</p>		<p>I ACKNOWLEDGE NOTICE AND ORAL APPROVAL OF AN INCREASE IN THE ORIGINAL ESTIMATED PRICE.</p>		
<p>AUTHORIZED BY CUSTOMER                  REX &amp; BETTY VAN</p>		<p>PHONE NO. 542-8070</p>		<p><b>Thank You!</b></p>		

# \* SHILOH \* AUTO \* REPAIR

1244 CENTRAL AVENUE  
SANTA ROSA, CA 95401

PHONE: (707) 523-4242

E Mail: shilohauto@juno.com

Bar #ACI38098

Page 1

## SERVICE ORDER

* DOMESTIC * * IMPORTS * * OIL CHANGES * * SMOG CHECK & REPAIR * * COMPLETE AUTO REPAIR * * BRAKES *			CUSTOMER NAME & ADDRESS 3935 ... SANTA ROSA, CA. 95409 (7... ) (707... )		DATE & TIME 4:50 PM 09/05/2002 WRITTEN BY PROMISED 09/05/2002	LABOR IS GUARANTEED FOR (WHICHEVER COMES FIRST) MILES: DAYS: 2000 190 DAILY STORAGE FEE AFTER 72 HOURS 19.00 HOURLY LABOR RATE 75.00 DIAGNOSTIC FEE 75.00 ALL PARTS ARE NEW UNLESS SPECIFIED AS USED (U) OR REBUILT (R) NEW TIRE TAX \$1.00 EACH
VEHICLE LICENSE NO. 2JHY101	ODOMETER 127196	VEHICLE DESCRIPTION 1988 Chevrolet Suburb	VEHICLE IDENTIFICATION NO.		<input type="checkbox"/> DELIVER <input type="checkbox"/> WILL CALL <input type="checkbox"/> PHONE WHEN READY	
PAYMENT METHOD CK 3838		CREDIT AUTHORIZATION				
<b>SERVICE REPAIR INSTRUCTIONS / SYMPTOMS</b> BRAKES						

TECH.	QTY	PART NO.	REPAIR / SERVICE DESCRIPTION	PARTS	LABOR
			CHECK BRAKES FOR LOCKING UP		0.00
			A/C SYST. SERVICE		75.00
			TURNED BOTH FRONT ROTORS		60.00
			REPACKED WHEEL BEARINGS		0.00
			R&R ROTORS		75.00
	1	R-12	R-12 REFRIDGERENT	90.00	
	1	FLOURO DYE	FLOURO DYE Installed dye to test for leaks. System has 3 pounds, requires 7. Compressor noisy.	18.95	

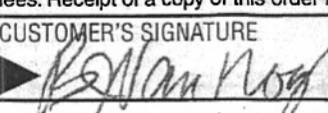
CUSTOMER REQUESTED RETURNED PARTS <input type="checkbox"/> YES <input type="checkbox"/> NO			<b>SAFETY RECOMMENDATIONS</b>			<b>TOTALS</b>	
I, the registered owner, authorize you to perform the above repairs and furnish necessary materials. I understand any cost quoted heretofore is an estimate only. Your employees may operate vehicle for inspection, testing, delivery at my risk. You will not be responsible for loss or damage to vehicle or articles left in it. I agree to pay reasonable storage on vehicle left more than 48 hours after notification that repairs are completed. An express Mechanic's Lien is acknowledged on above vehicle to secure the amount of repairs thereto, including those from any prior work or repair contract on this vehicle. In the event an attorney is retained to foreclose this lien or to bring suit to collection of any sums due, I agree to pay costs of collection and any reasonable attorney fees. Receipt of a copy of this order is hereby acknowledged.						LABOR	210.00
CUSTOMER'S SIGNATURE 						PARTS	108.95
Warranty. repairs based on guaranteed labor for this invoice must be performed at this location.						SALE TAX	8.17
REVISED ESTIMATE BY						GASOLINE	
PARTS 108.95 LABOR 210.00 TOTAL 320.95			DATE 09/05/02 TIME 4:19 PM		HAZ CHRG.	2.00	
AUTHORIZED BY CUSTOMER VAN NOY			PHONE NO. 542-8070		SUB-LET	( )	
I ACKNOWLEDGE NOTICE AND ORAL APPROVAL OF AN INCREASE IN THE ORIGINAL ESTIMATED PRICE.						DEPOSIT	
Thank You!						<b>TOTAL</b>	<b>329.12</b>



**\*TIRE CENTER FINAL MEMBER INVOICE\***

INVOICE# 0410011452

DATE 8/08/2002

NAME E

PHONE 7-0 ALT PHONE

MEMBERSHIP# 803414976000

ADDRESS

CITY SANTA ROSA

ST CA ZIP 95409

YEAR 1988 MAKE CHEVY TRUCKS

MODEL C20 Chevy

OPTION 4x2

ODOMETER READING 29466

COLOR BLUE

VEH. LIC# 2JHY101

SALESPERSON VIC

RECOMMENDED AIR PRESSURE FRONT 44 REAR 80 WHEEL TORQUE 120 WEIGHT BALANCE ALLOY STEEL X

QTY	DESCRIPTION	SLIP PRINT
4	<b>ITEM#</b> 94066 <b>MANUF</b> <b>TYPE</b> MICHELIN X RADIAL LT <b>SIZE</b> ALL SEASON ORBL LT235/85R16 10 PLY	
	<b>ITEM#</b> <b>MANUF</b> <b>TYPE</b> <b>SIZE</b>	
4	<b>6850 Auto and Light Truck/Van</b> <b>Installation includes:</b> Lifetime balance and rotation (per wheel on same wheel), new valve stem	
4	<b>7023 CW Disposal Fee</b>	
	<b>6841 Seasonal Exchange</b>	
	<b>8399 Stud Fee</b>	
	<b>6861 Extra Balance</b>	
	<b>Flat Repair</b>	N/C
	<b>Rotation</b>	N/C
	<b>Rebalance</b>	N/C
	<b>Road Hazard Warranty</b>	
	<b>Mileage Adjustment</b>	
	<b>Manuf. Defect</b>	
	<b>Member Services</b>	

DOT 1 B7EMBN5X2702  
 DOT 2 B7EMBN5X2702  
 DOT 3 B7EMBN5X2702  
 DOT 4 B7EMBN5X2702  
 DOT 5  
 DOT 6  
 DOT 7  
 DOT 8

WORK TO BE DONE

SERVICE NOTES

L/F      R/F  
 L/R      R/R  
 S

DINGS AND SCRATCHES ON VEHICLE AND WHEELS MIKE

VICTOR STOKES

\_\_\_ Best to Spare  
 \_\_\_ Static \_\_\_ Dynamic  
 \_\_\_ Blackwall  
 \_\_\_ Whitewall

- Nine Point Quality Assurance Release
- Rotate and Rebalance every 7,500 miles.
  - It is recommended that lug nuts be re-tightened after first 25 miles.
  - Costco Wholesale is not responsible for valuables left in vehicle.



# TIRE CENTER MEMBER INVOICE

INVOICE# 0410011452  
DATE 8/08/2002

NAME \_\_\_\_\_ PHONE \_\_\_\_\_ ALT PHONE \_\_\_\_\_ MEMBERSHIP# 803414976000  
ADDRESS 39: \_\_\_\_\_ CITY SANTA ROSA ST CA ZIP 95409  
YEAR 1988 MAKE CHEVY TRUCKS MODEL C20 Chevy OPTION 4x2  
ODOMETER READING 29,446.3 COLOR BLUE VEH. LIC# 2JHY101 SALESPERSON VIC

RECOMMENDED AIR PRESSURE FRONT 44 REAR 80 WHEEL TORQUE 120 WEIGHT BALANCE ALLOY STEEL X

QTY	DESCRIPTION
4	ITEM# 94066 MANUF MICHELIN X RADIAL LT TYPE ALL SEASON ORBL SIZE LT235/85R16 10 PLY
4	6850 Auto and Light Truck/Van Installation includes: Lifetime balance and rotation (per wheel on same wheel), new valve stem
4	7023 CW Disposal Fee
	6841 Seasonal Exchange
	8399 Stud Fee
	6861 Extra Balance
	Flat Repair N/C
	Rotation N/C
	Rebalance N/C
	Road Hazard Warranty
	Mileage Adjustment
	Manuf. Defect
	Member Services

SLIP PRINT

\*ECOLOGSTAR MEMBER #803414976000  
 \* 14 # 139.99  
 \* 94066 XLT235/85R16 559.96 T  
 \* 4 @ 1.00  
 \* STATE FEE 4.00 T  
 \* 4 @ 9.00  
 \* MNT/BALANCE 36.00  
 \* 4 @ 1.00  
 \* TIRE DISPOSAL 4.00  
 \* 7.50% TAX RATE 42.30  
 \* TOTAL 646.26  
 \* American Express 646.26  
 \* CHANGE .00  
 \* TOTAL NUMBER OF ITEMS SOLD = 4  
 \* CASHIER: BRET TIRES REG#97  
 \* 8/08/2002 10:29 0041 77 0008 69

DOT 1 B7EMBN5X2702  
 DOT 2 B7EMBN5X2702  
 DOT 3 B7EMBN5X2702  
 DOT 4 B7EMBN5X2702  
 DOT 5  
 DOT 6  
 DOT 7  
 DOT 8

WORK TO BE DONE

SERVICE NOTES

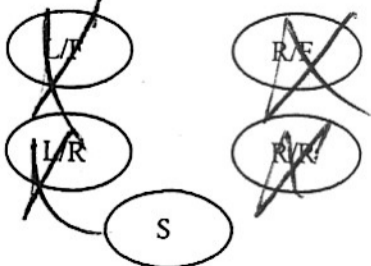

- Best to Spare
- Static  Dynamic
- Blackwall
- Whitewall

- Rotate and Rebalance every 7,500 miles.
- It is recommended that lug nuts be re-tightened after first 25 miles.
- Costco Wholesale is not responsible for valuables left in vehicle.

BAR #: AK201859  
EPA# CAL 000205358  
440 DUTTON AVE #9  
SANTA ROSA, CA 95407  
Phone: (707) 578-0200 FAX: 523-0206

Work Order No. **120418004** Order Date: **04/18/02** 08:26 am Page 1

3: ISTA  
SANTA ROSA CA 95409  
Hm: ! 0  
Wk: 900 2000

88 CHEVROLET SUBURBAN  
Mileage in:28289 out:  
Lic: 2JHY101 Cyl Eng  
Vin:  
Equipment:  
Profile:

Quotes  
1 04/18/02 11:14am 960.00  
BETTY in person.

**Job01 CHECK AND ADVISE REAR SHOCKS Labor: \$80.00**

CHECK AND ADVISE REAR SHOCKS. LEFT REAR IS HANGING LOW.

VEHICLE NEEDS REAR LEAF SPRINGS. ESTIMATED COST OF REAR LEAF SPRINGS REPLACEMENT IS \$960.00 PARTS AND LABOR.

Status: Not started Tech: JOHN 14

Job Subtotal: \$80.00

**Job02 R&R REAR LEAF SPRINGS Labor: \$400.00**

EST LEAF SPRINGS-S 2.0 @ 280.00 =\$ 560.00 560.00

Status: Not started Tech: JOHN 14

Job Subtotal: \$960.00

All parts are new unless stated.

ALL REPAIRS ARE WARRANTED FOR 12 MONTHS OR 12,000 MILES, WHICHEVER OCCURS FIRST, UNLESS OTHERWISE STATED IN WRITING ON THIS REPAIR ORDER. THIS IS A NATION WIDE WARRANTY GOOD AT ANY NAPA AUTO CARE CENTER.

IF YOU ARE WITHIN TWENTY FIVE (25) MILES OF THIS REPAIR FACILITY YOU MUST RETURN HERE FOR WARRANTY REPAIRS. IF YOU ARE BEYOND TWENTY FIVE (25) MILES YOU MUST CALL 1-800-452-NAPA TO AUTHORIZE REPAIRS.

I HEREBY ACKNOWLEDGE THAT I HAVE RECEIVED A COPY OF THE WARRANTY AND UNDERSTAND THE TERMS AND CONDITIONS OF THE WARRANTY.

28,413.3  
4-25-02

CUSTOMER SIGNATURE

ALL ESTIMATES INCLUDE A \$3.75 CHARGE FOR HAZARDOUS WASTE DISPOSAL FEE. IF

----->----->----->---Continued on the next page--->----->----->----->

BAR #: AK201859

120418004

EPA# CAL 000205358

440 DUTTON AVE #9

SANTA ROSA, CA 95407

Phone: (707) 578-0200 FAX: 523-0206

THERE ARE NO HAZARDOUS MATERIALS ASSOCIATED WITH THIS REPAIR THEN THIS FEE WILL BE REMOVED FROM THE FINAL INVOICE.

N=New, U=Used, R=Rebuilt

NO WARRANTY ON CUSTOMER SUPPLIED PARTS. LABOR WARRANTY APPLIES ONLY TO REPAIRS DONE AT THIS SHOP. LABOR WARRANTY DOES NOT APPLY UNLESS REPAIRS ARE DONE AT THIS SHOP. WARRANTY DOES NOT INCLUDE TOWING OR RENTAL VEHICLE.

All Parts are new unless otherwise stated.

Payments to NORTH BAY AUTO CENTER

Cost Summary

Status: New Work Order

Payments: \$560.00

1 4/18/02 560.00 Check

Labor	480.00
Parts	560.00
HAZARDIOUS WASE	3.75
Subtotal	1,043.75
Tax	42.00
Total	\$1,085.75
Payments	560.00
Bal Due	525.75

Thank you for choosing NORTH BAY AUTO CENTER



# \* SHILOH \* AUTO \* REPAIR

1244 CENTRAL AVENUE  
SANTA ROSA, CA 95401

PHONE: (707) 523-4242

E Mail: shilohauto@juno.com

Page 1

## SERVICE ORDER

<p>* DOMESTIC * * IMPORTS * * OIL CHANGES * * SMOG CHECK &amp; REPAIR * * COMPLETE AUTO REPAIR * * BRAKES *</p>		<p>CUSTOMER NAME &amp; ADDRESS L. Y. 3944 AL AVE SANTA ROSA, CA. 95409 (707) 523-7070 (707) 523-7070</p>		<p>DATE &amp; TIME 12:59 PM 02/09/2001 WRITTEN BY PROMISED 02/09/2001</p>		<p>LABOR IS GUARANTEED FOR (WHICHEVER COMES FIRST) MILES: 2000 DAYS: 90 DAILY STORAGE FEE AFTER 72 HOURS: 19.00 HOURLY LABOR RATE: 59.82 DIAGNOSTIC FEE: 75.00 ALL PARTS ARE NEW UNLESS SPECIFIED AS USED (U) OR REBUILT (R) NEW TIRE TAX \$1.00 EACH</p>	
VEHICLE LICENSE NO. EJHY101	ODOMETER 19737	VEHICLE DESCRIPTION 1988 Chevrolet Suburb	VEHICLE IDENTIFICATION NO.		<input type="checkbox"/> DELIVER <input type="checkbox"/> WILL CALL <input type="checkbox"/> PHONE WHEN READY PREPARED BY CERTIFIED BY		
PAYMENT METHOD Cash			CREDIT AUTHORIZATION				
<p><b>SERVICE REPAIR INSTRUCTIONS / SYMPTOMS</b></p> <p>OIL CHANGE</p>							

TECH.	QTY	PART NO.	REPAIR / SERVICE DESCRIPTION	PARTS	LABOR
			CAR CARE SERVICE		20.00
	8	10W30	10W30 OIL	20.00	
	1	PH29	PH29 OIL FILTER	5.93	
	1	WASHER	WASHER FLUID	4.05	
	1	115045	REPLACE FAN CLUTCH 115045 FAN CLUTCH	114.46	60.00
	1	MA	REPLACE SHOCKS (AIR SHOCKS) MA743\SUB643 AIR SHOCK KIT	166.16	90.77
	2.5	HAZ	HAZARDOUS WASTE CHARGE	0.00	
	1	AF348	AF348 AIR FILTER	6.44	

CUSTOMER REQUESTED RETURNED PARTS <input type="checkbox"/> YES <input type="checkbox"/> NO		<b>SAFETY RECOMMENDATIONS</b>		<b>TOTALS</b>	
I, the registered owner, authorize you to perform the above repairs and furnish necessary materials. I understand any cost quoted heretofore is an estimate only. Your employees may operate vehicle for inspection, testing, delivery at my risk. You will not be responsible for loss or damage to vehicle or articles left in it. I agree to pay reasonable storage on vehicle left more than 48 hours after notification that repairs are completed. An express Mechanic's Lien is acknowledged on above vehicle to secure the amount of repairs thereto, including those from any prior work or repair contract on this vehicle. In the event an attorney is retained to foreclose this lien or to bring suit for collection of any sums due, I agree to pay costs of collection and any reasonable attorney fees. Receipt of a copy of this order is hereby acknowledged.				LABOR	180.59
CUSTOMER'S SIGNATURE 				PARTS	317.94
Warranty repairs based on guaranteed labor for this invoice must be performed at this location.				SALE TAX	23.05
				GASOLINE	
				HAZ CHRG.	5.50
				SUB-LET	( )
				DEPOSIT	
				<b>TOTAL</b>	<b>527.08</b>

Thank You!

REVISED ESTIMATE	PARTS 317.94	LABOR 180.59	TOTAL 504.03	DATE 02/09/01	TIME 12:59 PM	I ACKNOWLEDGE NOTICE AND ORAL APPROVAL OF AN INCREASE IN THE ORIGINAL ESTIMATED PRICE.
BY	AUTHORIZED BY CUSTOMER VAN NOY		PHONE NO. 542-8070			

# \* SHILOH \* AUTO \* REPAIR

1244 CENTRAL AVENUE  
SANTA ROSA, CA 95401

PHONE: (707) 523-4242

E Mail: shilohauto@juno.com

Page 1

## SERVICE ORDER

5517

<p>* DOMESTIC * * IMPORTS * * OIL CHANGES * * SMOG CHECK &amp; REPAIR * * COMPLETE AUTO REPAIR * * BRAKES *</p>		<p>CUSTOMER NAME &amp; ADDRESS 3937 7A AVE SANTA ROSA, CA. 95409 (707) 523-4242 (707) 523-4242</p>		<p>DATE &amp; TIME 8:42 AM 04/05/2001 WRITTEN BY PROMISED 04/05/2001</p>		<p>LABOR IS GUARANTEED FOR (WHICHEVER COMES FIRST) MILES: 2000 DAYS: 90 DAILY STORAGE FEE AFTER 72 HOURS: 19.00 HOURLY LABOR RATE: 69.00 DIAGNOSTIC FEE: 75.00 ALL PARTS ARE NEW UNLESS SPECIFIED AS USED (U) OR REBUILT (R) NEW TIRE TAX \$1.00 EACH</p>	
VEHICLE LICENSE NO. 2JHY101	ODOMETER 20554	VEHICLE DESCRIPTION 1988 Chevrolet Suburb	VEHICLE IDENTIFICATION NO.		<input type="checkbox"/> DELIVER <input type="checkbox"/> WILL CALL <input type="checkbox"/> PHONE WHEN READY		
PAYMENT METHOD ck 3189			CREDIT AUTHORIZATION		PREPARED BY		
<p><b>SERVICE REPAIR INSTRUCTIONS / SYMPTOMS</b></p> <p>SMDG</p>							
CERTIFIED BY				LABOR			

TECH.	QTY	PART NO.	REPAIR / SERVICE DESCRIPTION	PARTS	LABOR
			SMDG CHECK CUSTOMER DECLINES PRE TEST		44.75
	1	SMDG CERT	SMDG CERTIFICATE	8.25	
	1	31615	31615 GAS CAP	12.80	

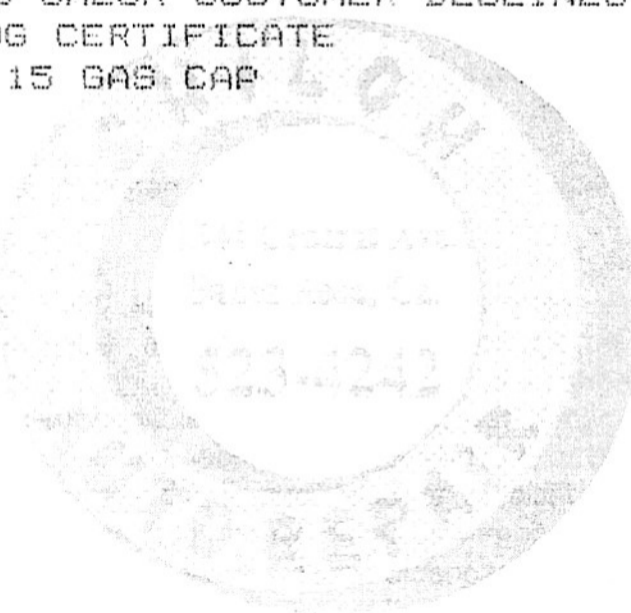

<p>CUSTOMER REQUESTED RETURNED PARTS <input type="checkbox"/> YES <input type="checkbox"/> NO</p> <p>I, the registered owner, authorize you to perform the above repairs and furnish necessary materials. I understand any cost quoted heretofore is an estimate only. Your employees may operate vehicle for inspection, testing, delivery at my risk. You will not be responsible for loss or damage to vehicle or articles left in it. I agree to pay reasonable storage on vehicle left more than 48 hours after notification that repairs are completed. An express Mechanic's Lien is acknowledged on above vehicle to secure the amount of repairs thereto, including those from any prior work or repair contract on this vehicle. In the event an attorney is retained to foreclose this lien or to bring suit for collection of any sums due, I agree to pay costs of collection and any reasonable attorney fees. Receipt of a copy of this order is hereby acknowledged.</p>		<p><b>SAFETY RECOMMENDATIONS</b></p>		<p><b>TOTALS</b></p>	
<p>CUSTOMER'S SIGNATURE ▶ <i>[Signature]</i></p> <p>Warranty repairs based on guaranteed labor for this invoice must be performed at this location.</p>				<p>LABOR 44.75 PARTS 12.80 SALE TAX 0.93 GASOLINE STATE CERT 8.25 SUB-LET ( ) DEPOSIT</p>	
				<p><b>TOTAL 66.73</b></p>	

*Thank You!*

REVISED ESTIMATE	PARTS 21.05	LABOR 44.75	TOTAL 65.80	DATE 04/05/01	TIME 8:42 AM	<p>I ACKNOWLEDGE NOTICE AND ORAL APPROVAL OF AN INCREASE IN THE ORIGINAL ESTIMATED PRICE. ▶ <i>[Signature]</i></p>
BY	AUTHORIZED BY CUSTOMER VAN NOY		PHONE NO. 542-8070			

# \* SHILOH \* AUTO \* REPAIR

1244 CENTRAL AVENUE  
SANTA ROSA, CA 95401  
PHONE: (707) 523-4242  
CA. BAR# AC138098

E Mail: shilohauto@juno.com



Page 1

## SERVICE ORDER 10201

* DOMESTIC * * IMPORTS * * OIL CHANGES * * SMOG CHECK & REPAIR * * COMPLETE AUTO REPAIR * * BRAKES *		CUSTOMER NAME & ADDRESS 393 VISTA AVE SANTA ROSA, CA. 95409 (707) 807 (7 3-1 89		DATE & TIME 2:44 PM 08/20/2001	LABOR IS GUARANTEED FOR (WHICHEVER COMES FIRST) MILES: 2000 DAYS: 180	
VEHICLE LICENSE NO.	ODOMETER	VEHICLE DESCRIPTION	VEHICLE IDENTIFICATION NO.	WRITTEN BY	DAILY STORAGE FEE AFTER 72 HOURS	
2JHY101	24489	1988 Chevrolet Suburb			19.00	
PAYMENT METHOD			CREDIT AUTHORIZATION	PROMISED	HOURLY LABOR RATE	
Ck 3392				08/20/2001	59.82	
<b>SERVICE REPAIR INSTRUCTIONS / SYMPTOMS</b>  REPLACE O2 SENSOR					<input type="checkbox"/> DELIVER <input type="checkbox"/> WILL CALL <input type="checkbox"/> PHONE WHEN READY	DIAGNOSTIC FEE 75.00
					PREPARED BY  CERTIFIED BY	ALL PARTS ARE NEW UNLESS SPECIFIED AS USED (U) OR REBUILT (R)  NEW TIRE TAX \$1.00 EACH

TECH.	QTY	PART NO.	REPAIR / SERVICE DESCRIPTION	PARTS	LABOR
	1	AF521	REPLACE O2 SENSOR AF521 O2 SENSOR	52.50	60.00

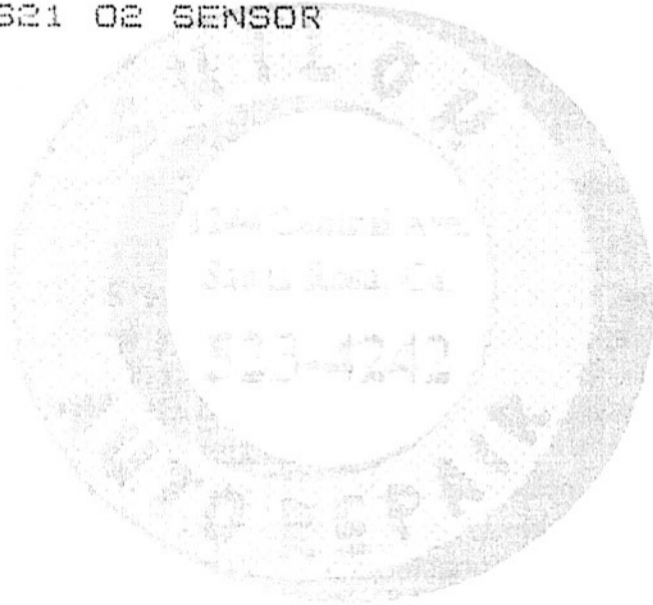

<b>SAFETY RECOMMENDATIONS</b>			CUSTOMER REQUESTED RETURNED PARTS <input type="checkbox"/> YES <input type="checkbox"/> NO		<b>TOTALS</b>	
I, the registered owner, authorize you to perform the above repairs and furnish necessary materials. I understand any cost quoted heretofore is an estimate only. Your employees may operate vehicle for inspection, testing, delivery at my risk. You will not be responsible for loss or damage to vehicle or articles left in it. I agree to pay reasonable storage on vehicle left more than 48 hours after notification that repairs are completed. An express Mechanic's Lien is acknowledged on above vehicle to secure the amount of repairs thereto, including those from any prior work or repair contract on this vehicle. In the event an attorney is retained to foreclose this lien or to bring suit for collection of any sums due, I agree to pay costs of collection and any reasonable attorney fees. Receipt of a copy of this order is hereby acknowledged.			CUSTOMER'S SIGNATURE <b>X</b> <i>Van Noy</i>		LABOR 60.00	
			SUB-LET ( )		PARTS 52.50	
			DEPOSIT		SALE TAX 3.51	
			<b>TOTAL</b>		GASOLINE	
REVISED ESTIMATE	PARTS 52.50 LABOR 60.00 TOTAL 112.50	DATE 08/20/01 TIME 2:44 PM	I ACKNOWLEDGE NOTICE AND ORAL APPROVAL OF AN INCREASE IN THE ORIGINAL ESTIMATED PRICE.		<b>Thank You!</b>	
BY	AUTHORIZED BY CUSTOMER VAN NOY	PHONE NO. 542-8070				

Warranty repairs based on guaranteed labor for this invoice must be performed at this location.

# \* SHILOH \* AUTO \* REPAIR

1244 CENTRAL AVENUE  
SANTA ROSA, CA 95401

PHONE: (707) 523-4242

E Mail: shilohauto@juno.com

Page 1

## SERVICE ORDER 10747

<p>* DOMESTIC * * IMPORTS * * OIL CHANGES * * SMOG CHECK &amp; REPAIR * * COMPLETE AUTO REPAIR * * BRAKES *</p>		<p>CUSTOMER NAME &amp; ADDRESS 3100 ... AVE SANTA ROSA, CA. 95409</p>		<p>DATE &amp; TIME 11:53 AM 11/29/2001</p>		<p>LABOR IS GUARANTEED FOR (WHICHEVER COMES FIRST) MILES: 2000 DAYS: 180</p>	
<p>VEHICLE LICENSE NO. EJHY101 ODOMETER 126386 VEHICLE DESCRIPTION 1989 Chevrolet Suburb VEHICLE IDENTIFICATION NO.</p>		<p>WRITTEN BY</p>		<p>PROMISED 11/29/2001</p>		<p>DAILY STORAGE FEE AFTER 72 HOURS 19.00</p>	
<p>PAYMENT METHOD <del>CASH</del> CK# 3520</p>		<p>CREDIT AUTHORIZATION</p>		<p><input type="checkbox"/> DELIVER <input type="checkbox"/> WILL CALL <input type="checkbox"/> PHONE WHEN READY</p>		<p>HOURLY LABOR RATE 75.00</p>	
<p><b>SERVICE REPAIR INSTRUCTIONS / SYMPTOMS</b></p>						<p>DIAGNOSTIC FEE 75.00</p>	
<p>LOF, HEADLIGHTS</p>						<p>ALL PARTS ARE NEW UNLESS SPECIFIED AS USED (U) OR REBUILT (R)</p>	
<p>PREPARED BY</p>						<p>NEW TIRE TAX \$1.00 EACH</p>	
<p>CERTIFIED BY</p>							

TECH.	QTY	PART NO.	REPAIR / SERVICE DESCRIPTION	PARTS	LABOR
			LOF OIL CHANGE		20.00
	8	10W30	10W30 OIL	20.00	
	1	PH1218	PH1218 OIL FILTER	6.03	
	0.5	WASHER	WASHER FLUID	3.60	
			ADJUST HEADLAMPS		37.50
			needs tires, front brakes-4000 miles		

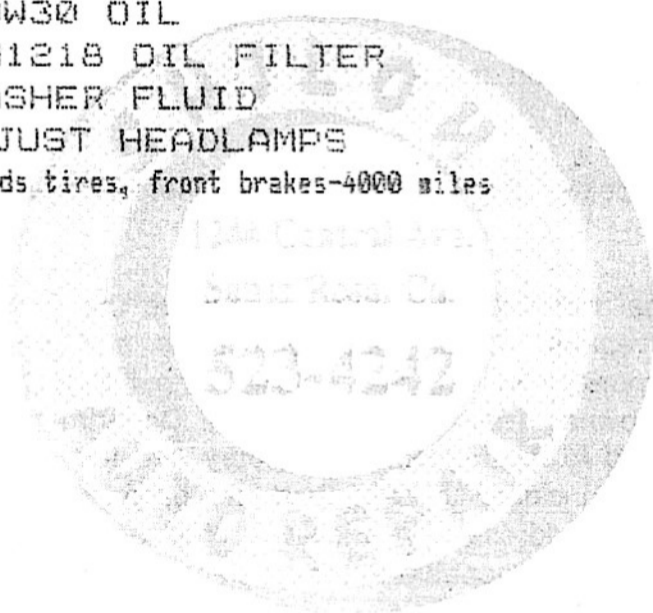

<p>CUSTOMER REQUESTED RETURNED PARTS <input type="checkbox"/> YES <input type="checkbox"/> NO</p>		<p><b>SAFETY RECOMMENDATIONS</b></p>				<p><b>TOTALS</b></p>	
<p>I, the registered owner, authorize you to perform the above repairs and furnish necessary materials. I understand any cost quoted heretofore is an estimate only. Your employees may operate vehicle for inspection, testing, delivery at my risk. You will not be responsible for loss or damage to vehicle or articles left in it. I agree to pay reasonable storage on vehicle left more than 48 hours after notification that repairs are completed. An express Mechanic's Lien is acknowledged on above vehicle to secure the amount of repairs thereto, including those from any prior work or repair contract on this vehicle. In the event an attorney is retained to foreclose this lien or to bring suit for collection of any sums due, I agree to pay costs of collection and any reasonable attorney fees. Receipt of a copy of this order is hereby acknowledged.</p>						<p>LABOR 20.00</p>	
<p>CUSTOMER'S SIGNATURE X [Signature]</p>						<p>PARTS 29.63</p>	
<p>Warranty repairs based on guaranteed labor for this invoice must be performed at this location.</p>						<p>SALE TAX 2.10</p>	
<p>REVISSED ESTIMATE BY</p>						<p>GASOLINE</p>	
<p>PARTS 29.63</p>		<p>LABOR 57.50</p>		<p>TOTAL 87.13</p>		<p>SUB-LET ( )</p>	
<p>DATE 11/29/01</p>		<p>TIME 11:53 AM</p>		<p>PHONE NO. 542-8070</p>		<p>DEPOSIT</p>	
<p>I ACKNOWLEDGE NOTICE AND ORAL APPROVAL OF AN INCREASE IN THE ORIGINAL ESTIMATED PRICE.</p>						<p><b>TOTAL 89.28</b></p>	

Thank You!

# \* SHILOH \* AUTO \* REPAIR

1244 CENTRAL AVENUE  
SANTA ROSA, CA 95401

PHONE: (707) 523-4242

E Mail: shilohauto@juno.com

Page 1

## SERVICE ORDER

9896

<p>* DOMESTIC * * IMPORTS * * OIL CHANGES * * SMOG CHECK &amp; REPAIR * * COMPLETE AUTO REPAIR * * BRAKES *</p>		<p>CUSTOMER NAME &amp; ADDRESS  AVE SANTA ROSA, CA. 95409 / 707-523-4242 172</p>		<p>DATE &amp; TIME 10:41 AM 06/26/2001</p>	<p>LABOR IS GUARANTEED FOR (WHICHEVER COMES FIRST) MILES: 2000 DAYS: 180 DAILY STORAGE FEE AFTER 72 HOURS: 19.00 HOURLY LABOR RATE: 69.82 DIAGNOSTIC FEE: 75.00 ALL PARTS ARE NEW UNLESS SPECIFIED AS USED (U) OR REBUILT (R) NEW TIRE TAX \$1.00 EACH</p>
VEHICLE LICENSE NO. 2JHY101	ODOMETER 122030	VEHICLE DESCRIPTION 1988 Chevrolet Suburb	VEHICLE IDENTIFICATION NO.	<p>WRITTEN BY</p>	<p>PROMISED 06/18/2001</p> <p><input type="checkbox"/> DELIVER <input type="checkbox"/> WILL CALL <input type="checkbox"/> PHONE WHEN READY</p>
PAYMENT METHOD CK# 1022		CREDIT AUTHORIZATION		<p>PREPARED BY</p>	
<p><b>SERVICE REPAIR INSTRUCTIONS / SYMPTOMS</b></p> <p>LOF</p>					

TECH.	QTY	PART NO.	REPAIR / SERVICE DESCRIPTION	PARTS	LABOR
			CAR CARE SERVICE		20.00
	1	PH1218	PH1218 OIL FILTER	6.93	
	0	10W30	10W30 OIL	20.00	
	0.5	COOLANT	COOLANT	6.00	
			REPLACE THERMOSTAT & HOUSING		55.86
	1	33008	33008 THERMOSTAT	9.20	
	1	GASKET	GASKET	4.70	
	1	15-1461	15-1461 WATER OUTLET HOUSING	9.62	
			REPLACE LOWER CONTROL ARM, R & L		349.10
	1	12548033	12548033 CONTROL ARM	396.98	
	1	12548034	12548034 CONTROL ARM	396.98	
			ALIGNMENT		104.93
			FREIGHT		60.00
	3	HAZ	HAZARDOUS WASTE CHARGE	0.00	

<p>CUSTOMER REQUESTED RETURNED PARTS <input type="checkbox"/> YES <input type="checkbox"/> NO</p> <p>I, the registered owner, authorize you to perform the above repairs and furnish necessary materials. I understand any cost quoted heretofore is an estimate only. Your employees may operate vehicle for inspection, testing, delivery at my risk. You will not be responsible for loss or damage to vehicle or articles left in it. I agree to pay reasonable storage on vehicle left more than 48 hours after notification that repairs are completed. An express Mechanic's Lien is acknowledged on above vehicle to secure the amount of repairs thereto, including those from any prior work or repair contract on this vehicle. In the event an attorney is retained to foreclose this lien or to bring suit for collection of any sums due, I agree to pay costs of collection and any reasonable attorney fees. Receipt of a copy of this order is hereby acknowledged.</p> <p>CUSTOMER'S SIGNATURE <i>B. Van Noy</i></p> <p>Warranty repairs based on guaranteed labor for this invoice must be performed at this location.</p>	<p><b>SAFETY RECOMMENDATIONS</b></p>	<p><b>TOTALS</b></p> <p>LABOR 589.89 PARTS 850.41 SALE TAX 61.65 GASOLINE HAZ CHRG. 3.00 SUB-LET ( ) DEPOSIT <b>TOTAL 1504.95</b></p>
---	--------------------------------------	---

Thank You!

REVISED ESTIMATE	PARTS 850.41	LABOR 589.89	TOTAL 1443.30	DATE 06/26/01	TIME 10:41 AM	<p>I ACKNOWLEDGE NOTICE AND ORAL APPROVAL OF AN INCREASE IN THE ORIGINAL ESTIMATED PRICE.</p> <p><i>B</i></p>
BY	AUTHORIZED BY CUSTOMER VAN NOY		PHONE NO. 542-8070			

# \* SHILOH \* AUTO \* REPAIR

1244 CENTRAL AVENUE  
SANTA ROSA, CA 95401

PHONE: (707) 523-4242

E Mail: shilohauto@juno.com

Page 1

## SERVICE ORDER

7958

<p>* DOMESTIC * * IMPORTS * * OIL CHANGES * * SMOG CHECK &amp; REPAIR * * COMPLETE AUTO REPAIR * * BRAKES *</p>		<p>CUSTOMER NAME &amp; ADDRESS VAN NOY 1244 CENTRAL AVE SANTA ROSA, CA. 95401 (707) 542-8070</p>		<p>DATE &amp; TIME 10:35 AM 05/25/2000 WRITTEN BY PROMISED 05/25/2000</p>		<p>LABOR IS GUARANTEED FOR (WHICHEVER COMES FIRST) MILES: 2000 DAYS: 90 DAILY STORAGE FEE AFTER 72 HOURS: 19.00 HOURLY LABOR RATE: 64.92 DIAGNOSTIC FEE: 75.00 ALL PARTS ARE NEW UNLESS SPECIFIED AS USED (U) OR REBUILT (R) NEW TIRE TAX \$1.00 EACH</p>	
VEHICLE LICENSE NO. 2JHY101	ODOMETER 12550	VEHICLE DESCRIPTION 88 CHEVY SUBURBAN	VEHICLE IDENTIFICATION NO.		<input type="checkbox"/> DELIVER <input type="checkbox"/> WILL CALL <input type="checkbox"/> PHONE WHEN READY		
PAYMENT METHOD <i>cash</i>		CREDIT AUTHORIZATION		PREPARED BY		CERTIFIED BY	

### SERVICE REPAIR INSTRUCTIONS / SYMPTOMS

LOF / COOLANT

TECH.	QTY	PART NO.	REPAIR / SERVICE DESCRIPTION	PARTS	LABOR
			LOF OIL CHANGE		18.00
	1	2098	AIR FILTER 2098	11.30	
	6	10W30	10W30 OIL	15.00	
	1	21061	21061 OIL FILTER	5.90	
	0.5	WASHER	WASHER FLUID	1.25	
			R&R COOLANT RECOVERY RESERVOIR		51.94
	1	15531514	15531514 COOLANT RECOVERY RESERVOIR	13.25	
	2.5	HAZ	HAZARDOUS WASTE CHARGE	0.00	

CUSTOMER REQUESTED RETURNED PARTS  YES  NO

### SAFETY RECOMMENDATIONS

### TOTALS

I, the registered owner, authorize you to perform the above repairs and furnish necessary materials. I understand any cost quoted heretofore is an estimate only. Your employees may operate vehicle for inspection, testing, delivery at my risk. You will not be responsible for loss or damage to vehicle or articles left in it. I agree to pay reasonable storage on vehicle left more than 48 hours after notification that repairs are completed. An express Mechanic's Lien is acknowledged on above vehicle to secure the amount of repairs thereto, including those from any prior work or repair contract on this vehicle. In the event an attorney is retained to foreclose this lien or to bring suit for collection of any sums due, I agree to pay costs of collection and any reasonable attorney fees. Receipt of a copy of this order is hereby acknowledged.

CUSTOMER'S SIGNATURE  
*[Signature]*

Warranty repairs based on guaranteed labor for this invoice must be performed at this location.

LABOR	69.94
PARTS	46.70
SALE TAX	3.50
GASOLINE	
HAZ CHRG.	2.50
SUB-LET	( )
DEPOSIT	
<b>TOTAL</b>	<b>122.64</b>

*Thank You!*

REVISED ESTIMATE	PARTS 46.70	LABOR 69.94	TOTAL 119.14	DATE 05/25/00	TIME 10:35 AM	I ACKNOWLEDGE NOTICE AND ORAL APPROVAL OF AN INCREASE IN THE ORIGINAL ESTIMATED PRICE.
BY	AUTHORIZED BY CUSTOMER VAN NOY		PHONE NO. 542-8070			

# \* SHILOH \* AUTO \* REPAIR

1244 CENTRAL AVENUE  
SANTA ROSA, CA 95401

PHONE: (707) 523-4242

E Mail: shilohauto@juno.com

Page 1

## SERVICE ORDER

5806

<p>* DOMESTIC * * IMPORTS * * OIL CHANGES * * SMOG CHECK &amp; REPAIR * * COMPLETE AUTO REPAIR * * BRAKES *</p>		<p>CUSTOMER NAME &amp; ADDRESS</p> <p>AVE SANTA ROSA, CA. 95409 (707) (707)</p>		<p>DATE &amp; TIME</p> <p>3:42 PM 10/24/2000</p>	<p>LABOR IS GUARANTEED FOR (WHICHEVER COMES FIRST)</p> <p>MILES: 2000 DAYS: 90</p>
<p>VEHICLE LICENSE NO. 2JHY101</p>		<p>ODOMETER 115570</p>	<p>VEHICLE DESCRIPTION 1988 Chevrolet Suburb</p>	<p>VEHICLE IDENTIFICATION NO.</p>	<p>LABOR IS GUARANTEED FOR (WHICHEVER COMES FIRST)</p> <p>DAILY STORAGE FEE AFTER 72 HOURS 19.00</p>
<p>PAYMENT METHOD <i>David B. ...</i></p>		<p>CREDIT AUTHORIZATION</p>		<p>PROMISED 10/24/2000</p>	<p>HOURLY LABOR RATE 69.82</p>
<p><b>SERVICE REPAIR INSTRUCTIONS / SYMPTOMS</b></p> <p>IGNITION SWITCH</p>					<p>DIAGNOSTIC FEE 75.00</p>
<p>TECH. QTY PART NO. REPAIR / SERVICE DESCRIPTION PARTS LABOR</p>					<p>ALL PARTS ARE NEW UNLESS SPECIFIED AS USED (U) OR REBUILT (R)</p>
<p>1 LOCK REPLACE IGNITION SWITCH L3C LOCK SWITCH &amp; EXTRA KEYS</p>					<p>NEW TIRE TAX \$1.00 EACH</p>



<p>CUSTOMER REQUESTED RETURNED PARTS <input type="checkbox"/> YES <input type="checkbox"/> NO</p>		<p><b>SAFETY RECOMMENDATIONS</b></p>			<p><b>TOTALS</b></p>	
<p>I, the registered owner, authorize you to perform the above repairs and furnish necessary materials. I understand any cost quoted heretofore is an estimate only. Your employees may operate vehicle for inspection, testing, delivery at my risk. You will not be responsible for loss or damage to vehicle or articles left in it. I agree to pay reasonable storage on vehicle left more than 48 hours after notification that repairs are completed. An express Mechanic's Lien is acknowledged on above vehicle to secure the amount of repairs thereto, including those from any prior work or repair contract on this vehicle. In the event an attorney is retained to foreclose this lien or to bring suit for collection of any sums due, I agree to pay costs of collection and any reasonable attorney fees. Receipt of a copy of this order is hereby acknowledged.</p>		<p><b>Thank You!</b></p>			<p>LABOR 140.00</p>	<p>PARTS 43.00</p>
<p>CUSTOMER'S SIGNATURE <i>D. Van Noy</i></p>		<p>Warranty repairs based on guaranteed labor for this invoice must be performed at this location.</p>			<p>SALE TAX 3.23</p>	<p>GASOLINE</p>
<p>REVISED ESTIMATE</p>	<p>PARTS 43.00</p>	<p>LABOR 140.00</p>	<p>TOTAL 183.00</p>	<p>DATE 10/24/00</p>	<p>TIME 3:42 PM</p>	<p>SUB-LET ( )</p>
<p>BY AUTHORIZED BY CUSTOMER VAN NOY</p>		<p>PHONE NO. 542-8070</p>			<p>DEPOSIT</p>	<p><b>TOTAL</b></p>
<p>I ACKNOWLEDGE NOTICE AND ORAL APPROVAL OF AN INCREASE IN THE ORIGINAL ESTIMATE</p>						

# \* SHILOH \* AUTO \* REPAIR

1244 CENTRAL AVENUE  
SANTA ROSA, CA 95401

PHONE: (707) 523-4242

E Mail: shilohauto@juno.com

BAR ARD #AC1380

## SERVICE ORDER

<p>Page 1</p> <p>* DOMESTIC * * IMPORTS * * OIL CHANGES * * SMOG CHECK &amp; REPAIR * * COMPLETE AUTO REPAIR * * BRAKES *</p>		<p>CUSTOMER NAME &amp; ADDRESS</p> <p>39 _____ A AVE SANTA ROSA, CA. 95409 (707) _____ (707) _____</p>		<p>DATE &amp; TIME</p> <p>11:33 AM 08/29/2000</p>		<p>LABOR IS GUARANTEED FOR (WHICHEVER COMES FIRST)</p> <p>MILES: _____ DAYS: 2000 90</p>	
<p>VEHICLE LICENSE NO. ODOMETER VEHICLE DESCRIPTION VEHICLE IDENTIFICATION NO.</p> <p>2THV101 11381A 1988 Chevrolet Suburb</p>		<p>PROMISED</p> <p>08/29/2000</p>		<p>DAILY STORAGE FEE AFTER 72 HOURS</p> <p>15.00</p>		<p>HOURLY LABOR RATE</p> <p>63.32</p>	
<p>PAYMENT METHOD</p> <p>Check # 2583 \$ 5479.71</p>		<p>CREDIT AUTHORIZATION</p>		<p><input type="checkbox"/> DELIVER <input type="checkbox"/> WILL CALL <input type="checkbox"/> PHONE WHEN READY</p>		<p>DIAGNOSTIC FEE</p> <p>75.00</p>	
<p><b>SERVICE REPAIR INSTRUCTIONS / SYMPTOMS</b></p> <p>REPLACE ENGINE AND TRANSMISS.</p>						<p>ALL PARTS ARE NEW UNLESS SPECIFIED AS USED (U) OR REBUILT (R)</p>	
<p>PREPARED BY</p>						<p>NEW TIRE TAX \$1.00 EACH</p>	
<p>CERTIFIED BY</p>							

TECH.	QTY	PART NO.	REPAIR / SERVICE DESCRIPTION	PARTS	LABOR
			REPLACE ENGINE <i>Crate</i>		1326.58
			REBUILD TRANSMISSION		400.00
			REMOVE AND REPLACE TRANSMISSION		237.39
	1	MASTER OVERHAUL	140 TRANSMISSION MASTER OVERHAUL KIT	280.00	
	1	9500	9500 REBUILT TORQUE CONVERTER	190.00	
	1	10955	10955 HEATER HOSE	8.13	
	1	15637109	15637109 ENGINE KIT	65.75	
	1	15637106	15637106 ENGINE KIT	282.20	
	1	125314543	12531454 L19 ENGINE	3825.00	
	1	RR250	RR250 IGNITION ROTOR	6.38	
	6	24	24 SPARK PLUG	18.00	
	1	7580	7580 LOWER HOSE	24.63	
	1	55-1002	55-1002 WATER PUMP	98.62	
	1	10955	10955 HEATER HOSE	8.13	
	1	MS-15188 N	MS-15188 NGA MANIFOLD	12.42	
	1	RR249	RR249 DIST. CAP	30.55	
	1	183	183 THERMOSTAT	10.06	

<p>CUSTOMER REQUESTED RETURNED PARTS <input type="checkbox"/> YES <input type="checkbox"/> NO</p>		<p><b>SAFETY RECOMMENDATIONS</b></p>		<p><b>TOTALS</b></p>	
<p>I, the registered owner, authorize you to perform the above repairs and furnish necessary materials. I understand any cost quoted heretofore is an estimate only. Your employees may operate vehicle for inspection, testing, delivery at my risk. You will not be responsible for loss or damage to vehicle or articles left in it. I agree to pay reasonable storage on vehicle left more than 48 hours after notification that repairs are completed. An express Mechanic's Lien is acknowledged on above vehicle to secure the amount of repairs thereto, including those from any prior work or repair contract on this vehicle. In the event an attorney is retained to foreclose this lien or to bring suit for collection of any sums due, I agree to pay costs of collection and any reasonable attorney fees. Receipt of a copy of this order is hereby acknowledged.</p>		<p>CUSTOMER'S SIGNATURE</p> <p>Warranty repairs based on guaranteed labor for this invoice must be performed at this location.</p>		<p>LABOR</p>	
				<p>PARTS</p>	
				<p>SALE TAX</p>	
				<p>GASOLINE</p>	
				<p>SUB-LET ( )</p>	
				<p>DEPOSIT</p>	
				<p><b>TOTAL</b></p>	

*Thank You!*

REVISSED ESTIMATE	PARTS	LABOR	TOTAL	DATE	TIME	<p>I ACKNOWLEDGE NOTICE AND ORAL APPROVAL OF AN INCREASE IN THE ORIGINAL ESTIMATED PRICE.</p>
BY	AUTHORIZED BY CUSTOMER		PHONE NO.			



# \* SHILOH \* AUTO \* REPAIR

1244 CENTRAL AVENUE  
SANTA ROSA, CA 95401

PHONE: (707) 523-4242

E Mail: shilohauto@juno.com

## SERVICE ORDER

<p>* DOMESTIC * * IMPORTS * * OIL CHANGES * * SMOG CHECK &amp; REPAIR * * COMPLETE AUTO REPAIR * * BRAKES *</p>		<p>CUSTOMER NAME &amp; ADDRESS LY 39 [unclear] 1244 AVE SANTA ROSA, CA. 95401 (707) [unclear]</p>		<p>DATE &amp; TIME 11:33 AM 08/29/2000</p>	<p>LABOR IS GUARANTEED FOR (WHICHEVER COMES FIRST) MILES: [unclear] DAYS: [unclear]</p>
VEHICLE LICENSE NO.	ODOMETER	VEHICLE DESCRIPTION	VEHICLE IDENTIFICATION NO.	WRITTEN BY	DAILY STORAGE FEE AFTER 72 HOURS
PAYMENT METHOD			CREDIT AUTHORIZATION	PROMISED 08/29/2000	HOURLY LABOR RATE
<p><b>SERVICE REPAIR INSTRUCTIONS / SYMPTOMS</b></p>				<input type="checkbox"/> DELIVER <input type="checkbox"/> WILL CALL <input type="checkbox"/> PHONE WHEN READY	DIAGNOSTIC FEE
				PREPARED BY	ALL PARTS ARE NEW UNLESS SPECIFIED AS USED (U) OR REBUILT (R)
				CERTIFIED BY	NEW TIRE TAX \$1.00 EACH

TECH.	QTY	PART NO.	REPAIR / SERVICE DESCRIPTION	PARTS	LABOR
	1	G-17797	G-17797 INJ. GASKET	3.25	
	2	F-20423 EX	F-20423 EXH GASKT	35.45	
	3	401-6300	401-6300 RFD CAP SCRE	2.55	
	1	G-31411	G-31411 THR BODY GASKET	3.15	
	1	SUB V8-454	SUB V8-454 A/C FAN & P/S BELT	21.72	
	1	7612 A/P,	7612 A/P, ALT & FAN BELT	31.34	
	1	7410	7410 POWER STEERING BELT	15.50	
	1	36-6029	36-6029 POWER STEERING PUMP	138.94	
			REMOVE AND REPLACE FRONT BRAKES		174.50
	2	4156SB BRA	4156SB BRAKE CAL	179.60	
	1	SSR-D153	SSR-D153 SEVERE DUTY PADS	89.61	
	2	105010	105010 F HUB/ROTOR ASSY	197.20	
	1	11592494	11592494 HOSE P/S	48.00	
	2.7	BRAKE FLUI	BRAKE FLUID	16.20	
	16	ATF	ATF	40.00	
	7	10/30 OIL	10/30 OIL	17.50	
	1	21061	21061 OIL FILTER	5.90	

<p>CUSTOMER REQUESTED RETURNED PARTS <input type="checkbox"/> YES <input type="checkbox"/> NO</p>		<p><b>SAFETY RECOMMENDATIONS</b></p>		<p><b>TOTALS</b></p>	
<p>I, the registered owner, authorize you to perform the above repairs and furnish necessary materials. I understand any cost quoted heretofore is an estimate only. Your employees may operate vehicle for inspection, testing, delivery at my risk. You will not be responsible for loss or damage to vehicle or articles left in it. I agree to pay reasonable storage on vehicle left more than 48 hours after notification that repairs are completed. An express Mechanic's Lien is acknowledged on above vehicle to secure the amount of repairs thereto, including those from any prior work or repair contract on this vehicle. In the event an attorney is retained to foreclose this lien or to bring suit for collection of any sums due, I agree to pay costs of collection and any reasonable attorney fees. Receipt of a copy of this order is hereby acknowledged.</p>		<p>CUSTOMER'S SIGNATURE [Signature]</p>		LABOR	
				PARTS	
				SALE TAX	
				GASOLINE	
<p>Warranty repairs based on guaranteed labor for this invoice must be performed at this location.</p>		<p>Thank You!</p>		SUB-LET	( )
				DEPOSIT	
				<b>TOTAL</b>	
REVISED ESTIMATE	PARTS	LABOR	TOTAL	DATE	TIME
BY	AUTHORIZED BY CUSTOMER		PHONE NO.	I ACKNOWLEDGE NOTICE AND ORAL APPROVAL OF AN INCREASE IN THE ORIGINAL ESTIMATED PRICE.	

# \* SHILOH \* AUTO \* REPAIR

1244 CENTRAL AVENUE  
SANTA ROSA, CA 95401

PHONE: (707) 523-4242

E Mail: shilohauto@juno.com

Page 3

## SERVICE ORDER

AREA

<p>* DOMESTIC * * IMPORTS * * OIL CHANGES * * SMOG CHECK &amp; REPAIR * * COMPLETE AUTO REPAIR * * BRAKES *</p>		<p>CUSTOMER NAME &amp; ADDRESS</p> <p>393 STA AVE SANTA ROSA, CA. 95409 (707) (707)</p>		<p>DATE &amp; TIME</p> <p>11:33 AM 08/29/2000</p>		<p>LABOR IS GUARANTEED FOR (WHICHEVER COMES FIRST)</p> <p>MILES: 2000 DAYS: 90</p>	
<p>VEHICLE LICENSE NO. ODOMETER VEHICLE DESCRIPTION VEHICLE IDENTIFICATION NO.</p> <p>2JHY101 11381A 1988 Chevrolet Suburb</p>		<p>WRITTEN BY</p>		<p>PROMISED</p> <p>08/29/2000</p>		<p>DAILY STORAGE FEE AFTER 72 HOURS</p> <p>19.00</p>	
<p>PAYMENT METHOD</p>		<p>CREDIT AUTHORIZATION</p>		<p><input type="checkbox"/> DELIVER <input type="checkbox"/> WILL CALL <input type="checkbox"/> PHONE WHEN READY</p>		<p>HOURLY LABOR RATE</p> <p>59.00</p>	
<p><b>SERVICE REPAIR INSTRUCTIONS / SYMPTOMS</b></p>						<p>DIAGNOSTIC FEE</p> <p>75.00</p>	
<p>PREPARED BY</p>						<p>ALL PARTS ARE NEW UNLESS SPECIFIED AS USED (U) OR REBUILT (R)</p>	
<p>CERTIFIED BY</p>						<p>NEW TIRE TAX \$1.00 EACH</p>	

TECH.	QTY	PART NO.	REPAIR / SERVICE DESCRIPTION	PARTS	LABOR
	6	HOSE CLAMP	HOSE CLAMPS	9.00	
	1	HEATER HOSE	HEATER HOSE 3 5/8"	10.95	
	4	O-	O RINGS	4.92	
	1	VACUUM TEE	VACUUM TEE	4.90	
	1	VACUUM HOS	VACUUM HOSE	0.50	
	1.5	FREON	FREON	57.00	
	3	COOLANT	COOLANT	36.00	
	5	CLEANER	CLEANER	29.50	
	11	HAZ	HAZARDOUS WASTE CHARGE	0.00	
	1	HAZ	----	0.00	

<p>CUSTOMER REQUESTED RETURNED PARTS <input type="checkbox"/> YES <input type="checkbox"/> NO</p>		<p><b>SAFETY RECOMMENDATIONS</b></p>		<p><b>TOTALS</b></p>	
<p>I, the registered owner, authorize you to perform the above repairs and furnish necessary materials. I understand any cost quoted heretofore is an estimate only. Your employees may operate vehicle for inspection, testing, delivery at my risk. You will not be responsible for loss or damage to vehicle or articles left in it. I agree to pay reasonable storage on vehicle left more than 48 hours after notification that repairs are completed. An express Mechanic's Lien is acknowledged on above vehicle to secure the amount of repairs thereto, including those from any prior work or repair contract on this vehicle. In the event an attorney is retained to foreclose this lien or to bring suit for collection of any sums due, I agree to pay costs of collection and any reasonable attorney fees. Receipt of a copy of this order is hereby acknowledged.</p>		<p>CUSTOMER'S SIGNATURE</p> <p><i>Bob Ken Hoy</i></p>		<p>LABOR 2134.50 PARTS 5000.55 SALE TAX 441.50 GASOLINE 407 CHRG 11.00 SUB-LET ( ) DEPOSIT</p>	
<p>Warranty repairs based on guaranteed labor for this invoice must be performed at this location.</p>		<p>5,479.71 paid upon finish 3,000 paid previous</p> <p><b>Thank You!</b></p>		<p><b>TOTAL 9479.71</b></p>	
<p>REVISED ESTIMATE BY</p> <p>5888 55</p>	<p>LABOR</p> <p>2134.50</p>	<p>TOTAL</p> <p>8038.07</p>	<p>DATE</p> <p>08/29/00</p>	<p>TIME</p> <p>11:19 AM</p>	<p>I ACKNOWLEDGE NOTICE AND ORAL APPROVAL OF AN INCREASE IN THE ORIGINAL ESTIMATED PRICE.</p>
<p>AUTHORIZED BY CUSTOMER</p> <p>UON NOV</p>		<p>PHONE NO.</p> <p>523-4242</p>		<p>→</p>	

# \* SHILOH \* AUTO \* REPAIR

1244 CENTRAL AVENUE  
SANTA ROSA, CA 95401

PHONE: (707) 523-4242

E Mail: shilohauto@juno.com

## SERVICE ORDER

6878

* DOMESTIC * * IMPORTS * * OIL CHANGES * * SMOG CHECK & REPAIR * * COMPLETE AUTO REPAIR * * BRAKES *		CUSTOMER NAME & ADDRESS  _____ IE AVE SANTA ROSA, CA. 95409 (707) _____ (707) _____		DATE & TIME 3:51 PM 11/03/1999 WRITTEN BY  PROMISED 11/03/1999	LABOR IS GUARANTEED FOR (WHICHEVER COMES FIRST)  MILES: 4000 DAYS: 90 DAILY STORAGE FEE AFTER 72 HOURS 19.00 HOURLY LABOR RATE 64.92 DIAGNOSTIC FEE 70.00 ALL PARTS ARE NEW UNLESS SPECIFIED AS USED (U) OR REBUILT (R) NEW TIRE TAX \$1.00 EACH
VEHICLE LICENSE NO.	ODOMETER	VEHICLE DESCRIPTION	VEHICLE IDENTIFICATION NO.		
9TLY101	100798	99 CHEVY SUBAN			
PAYMENT METHOD		CREDIT AUTHORIZATION			
CV 2493					
SERVICE REPAIR INSTRUCTIONS / SYMPTOMS					
BROWN COUPON SPECIAL					
TECH.			LABOR		

TECH.	QTY	PART NO.	REPAIR / SERVICE DESCRIPTION	PARTS	LABOR
	1	BROWN COUP	BROWN COUPON SPECIAL	29.95	
	9	HAZ	HAZARDOUS WASTE CHARGE	0.00	
	1	703-2447	703-2447 RADIATOR CAP	6.44	
	1	730 RADIAT	730 RADIATOR	408.90	
			R&R RADIATOR		116.86
	2.5	COOLANT	COOLANT	30.00	
	1	10W30	10W30 OIL	0.00	
	1	21061	OIL FILTER 21061	0.00	

CUSTOMER REQUESTED RETURNED PARTS <input type="checkbox"/> YES <input type="checkbox"/> NO I, the registered owner, authorize you to perform the above repairs and furnish necessary materials. I understand any cost quoted heretofore is an estimate only. Your employees may operate vehicle for inspection, testing, delivery at my risk. You will not be responsible for loss or damage to vehicle or articles left in it. I agree to pay reasonable storage on vehicle left more than 48 hours after notification that repairs are completed. An express Mechanic's Lien is acknowledged on above vehicle to secure the amount of repairs thereto, including those from any prior work or repair contract on this vehicle. In the event an attorney is retained to foreclose this lien or to bring suit for collection of any sums due, I agree to pay costs of collection and any reasonable attorney fees. Receipt of a copy of this order is hereby acknowledged.		<b>SAFETY RECOMMENDATIONS</b>		<b>TOTALS</b>	
CUSTOMER'S SIGNATURE 		I ACKNOWLEDGE NOTICE AND ORAL APPROVAL OF AN INCREASE IN THE ORIGINAL ESTIMATED PRICE.		LABOR 116.86 PARTS 475.29 SALE TAX 35.65 GASOLINE HAZ CHRG. 9.00 SUB-LET ( ) DEPOSIT <b>TOTAL 636.80</b>	
Warranty repairs based on guaranteed labor for this invoice must be performed at this location.		Thank You!			

REVISED ESTIMATE	PARTS	LABOR	TOTAL	DATE	TIME	
BY	475.29	116.86	601.15	11/03/99	3:51 PM	
	AUTHORIZED BY CUSTOMER			PHONE NO.		
	VAN NOY			542-8070		

# SHILOH AUTO REPAIR THANK YOU FOR CHOOSING US

1244 CENTRAL AVE

SANTA ROSA, CA 95401

523-4242

BAR#AC138098 EPA#CAL717803347

==== CUSTOMER =====

3:52 PM  
E  
39  
SANTA ROSA, CA. 95409

==== VEHICLE =====

SYMPTOM:  
SERVICE:  
YR/MAKE: 88 CHEVY SUBAN  
LICENSE: 2JHY101  
VIN  
MLE : 98, 574

Date: 06/18/98

Due Date: 06/16/98

WORK ORDER: 2859

2JHY101

PAGE: 1

COMMENTS AND DESCRIPTION OF CHARGES	PRICE	PARTS & LUBRICANTS USED	QTY.	PRICE	TOTAL
LOF-CAP CARE SERVICE	22.00	21061 OIL FILTER	1	5.36	5.36
AIR CONDITION SERVICE	45.00	20450 OIL	6	2.50	15.00
REPLACE UPPER HOSE	20.00	COOLANT, ANTI FREEZE	1	6.00	6.00
REPLACE FUEL FILTER	20.00	8396 UPPER HOSE	1	22.90	22.90
REMOVE AND REINSTALL DRIVE LINE	35.00	HOSE CLAMPS	2	1.50	3.00
DRIVE SHAFT REPAIR AND BALANCE	215.00	FREON	12.25	48.00	108.00
		18" WIPERS	1	15.90	15.90
		3484 FUEL FILTER	1	21.65	21.65

*Paul B. VanNoy*  
1843

LABOR	358.00	PARTS	197.81
SUBLET	0.00	SHOP SUPPLIES	0.00
		HAZ WASTE	2.95

This vehicle will be reassembled within  
3 days of the date shown above if I do  
not authorize the recommended services.

QUOTE (paying by ARRANGEMENT)  
THANK YOU FOR YOUR BUSINESS.

SUB-TOTAL	558.76
SALES TAX	14.84
TOTAL	573.60

Estimate Record

ACCEPTANCE SIGNATURE *Paul B. VanNoy*

DATE	TIME	PHONE	APPROVED BY	TOTAL	PARTS(add)	LABOR(add)	INCREASE	CALLER	REASON FOR ESTIMATE INCREASE
06/16/98	2:56P	-	BJ VANNOY	64.92	0.00	64.92			original estimate
06/18/98	3:51P	-	BJ VANNOY	571.60	197.81	293.08	490.89		
06/18/98	3:52P	-	BJ VANNOY	573.60	0.00	0.00	0.00		

I authorize the above repairs and necessary materials. Your employees may operate vehicle for inspection, testing, delivery at my risk. You will not be responsible for loss or damage to vehicle or items left in it. I agree to pay reasonable storage on vehicle left more than 48 hours after notification that repairs are completed. An express Mechanics Lien is acknowledged on above vehicle to secure the amount of repairs thereto. Labor is guaranteed for 90 days or 4000 miles whichever occurs first. All other guarantees are those made exclusively by the manufacturer. Warranty work that is based on this repair order must be performed at this shop. ALL ORDERED PARTS WILL BE RETURNED UNLESS INITIALLY WERE

**SERVICE ORDER**

3547

SHILOH AUTO REPAIR 1244 CENTRAL AVE SANTA ROSA, CA 95401 BAR#AC138098 EPA#CAL717803347 523-4242		CUSTOMER NAME & ADDRESS 31 F... SANTA ROSA, CA. 95409 (707) ... 70 (7) ... 389		DATE & TIME 9:24 AM 08/05/98	LABOR IS GUARANTEED FOR (WHICHEVER COMES FIRST) MILES: 2000 DAYS: 90 DAILY STORAGE FEE AFTER 72 HOURS 15.00 HOURLY LABOR RATE 64.92 DIAGNOSTIC FEE 64.92 ALL PARTS ARE NEW UNLESS SPECIFIED AS USED(U) OR REBUILT(R) COMPUTER ESTIMATING SYSTEM ACCESS CHARGE
VEHICLE LICENSE NO. 2JHY101 ODOMETER 100908 VEHICLE DESCRIPTION 88 CHEVY SUBAN VEHICLE IDENTIFICATION NO.		PROMISED 08/04/98 DELIVER <input type="checkbox"/> WILL CALL <input type="checkbox"/> PHONE WHEN READY <input type="checkbox"/> PREPARED BY CERTIFIED BY			
PAYMENT METHOD ESTIMATE CREDIT AUTHORIZATION		<b>SERVICE REPAIR INSTRUCTIONS / SYMPTOMS</b> OK ALTERNATOR			

TECH.	QTY	PART NO.	REPAIR / SERVICE DESCRIPTION	PARTS	LABOR
	1	7890-11	REPLACE ALTERNATER		65.00
	1	552	7890-11 REBUILT ALTERNATER 552 FLASHER	164.22 7.90	

*PAID  
CHK # 1903  
THANK YOU*

CUSTOMER REQUESTED RETURNED PARTS <input type="checkbox"/> YES <input type="checkbox"/> NO		<b>SAFETY RECOMMENDATIONS</b>				<b>TOTALS</b>		
I, the registered owner, authorize you to perform the above repairs and furnish necessary materials. I understand any cost quoted heretofore is an estimate only. Your employees may operate vehicle for inspection, testing, delivery at my risk. You will not be responsible for loss or damage to vehicle or articles left in it. I agree to pay reasonable storage on vehicle left more than 48 hours after notification that repairs are completed. An express Mechanic's Lien is acknowledged on above vehicle to secure the amount of repairs thereto, including those from any prior work or repair contract on this vehicle. In the event an attorney is retained to foreclose this lien or to bring suit for collection of any sums due, I agree to pay costs of collection and any reasonable attorney fees. Receipt of a copy of this order is hereby acknowledged.		<b>TIRES, BRAKES, BATTERY &amp; COOLANT</b>				LABOR	65.00	
		TIRES	RF	LF	RR	LR	SPARE	PARTS
CUSTOMER'S SIGNATURE <i>BJ Vannoy</i>		PSI					SALES TAX	12.91
Warantee repairs based on guaranteed labor for this invoice must be performed at this location.		BRAKES-F			BRAKES-R		GASOLINE	
		BATTERY					SUB-LET	( )
		COOLANT					DEPOSIT	
						<b>TOTAL</b>	<b>250.03</b>	
REVISED ESTIMATE BY	PARTS 172.12 LABOR 65.00 TOTAL 237.12	DATE 08/05/98 TIME 9:24 AM	I ACKNOWLEDGE NOTICE AND ORAL APPROVAL OF AN INCREASE IN THE ORIGINAL ESTIMATED PRICE.		AUTHORIZED BY CUSTOMER BJ VANNOY	PHONE NO. 542-0070		

# SERVICE ORDER

3760

SHILOH AUTO REPAIR 1244 CENTRAL AVE SANTA ROSA, CA 95401 BAR#AC138098 EPA#CAL717803347 523-4242		CUSTOMER NAME & ADDRESS 39 AVE. SANTA ROSA, CA. 95409 ( ) (70)		DATE & TIME 3:12 PM 08/21/98	LABOR IS GUARANTEED FOR (WHICHEVER COMES FIRST) MILES: 2000 DAYS: 90
VEHICLE LICENSE NO. 2JHY101	ODOMETER 03112	VEHICLE DESCRIPTION 88 CHEVY SUBAN	VEHICLE IDENTIFICATION NO.	WRITTEN BY	DAILY STORAGE FEE AFTER 72 HOURS 19.00
PAYMENT METHOD ESTIMATE		CREDIT AUTHORIZATION		PROMISED 08/21/98	HOURLY LABOR RATE 64.92
SERVICE REPAIR INSTRUCTIONS / SYMPTOMS OIL CHANGE & FRONT BRAKES				<input type="checkbox"/> DELIVER <input type="checkbox"/> WILL CALL <input type="checkbox"/> PHONE WHEN READY	DIAGNOSTIC FEE 64.92
				PREPARED BY	ALL PARTS ARE NEW UNLESS SPECIFIED AS USED(U) OR REBUILT(R)
				CERTIFIED BY	COMPUTER ESTIMATING SYSTEM ACCESS CHARGE

TECH.	QTY	PART NO.	REPAIR / SERVICE DESCRIPTION	PARTS	LABOR
	1	8891	8891 GREASE SEALS (2)	14.00	
	1	BRK CLN	BRAKE CLEAN, CHEMICAL CLEANER	7.90	
	1	AE-7084A-M	AE-7084A-M BRAKE PADS	65.15	
	1	BRAKE FLUID	BRAKE FLUID	4.00	
	6	10W30	10W30 OIL	12.00	
	1	21061	21061 OIL FILTER	5.36	
	1	2069	2069 AIR FILTER	10.60	
			REPLACE FRONT BRAKE PADS & REPACK WHEEL TURN ROTORS		90.00
	2.5	HAZ	HAZARDOUS WASTE CHARGE	0.00	80.00

Paid w/ check  
ck# 1938

CUSTOMER REQUESTED RETURNED PARTS <input type="checkbox"/> YES <input type="checkbox"/> NO		SAFETY RECOMMENDATIONS				TOTALS			
I, the registered owner, authorize you to perform the above repairs and furnish necessary materials. I understand any cost quoted heretofore is an estimate only. Your employees may operate vehicle for inspection, testing, delivery at my risk. You will not be responsible for loss or damage to vehicle or articles left in it. I agree to pay reasonable storage on vehicle left more than 48 hours after notification that repairs are completed. An express Mechanic's Lien is acknowledged on above vehicle to secure the amount of repairs thereto, including those from any prior work or repair contract on this vehicle. In the event an attorney is retained to foreclose this lien or to bring suit for collection of any sums due, I agree to pay costs of collection and any reasonable attorney fees. Receipt of a copy of this order is hereby acknowledged.		TIRES, BRAKES, BATTERY & COOLANT				LABOR	170.00		
		TIRES	RF	LF	RR	LR	SPARE	PARTS	119.01
		TREAD						SALES TAX	8.93
		PSI						GASOLINE	
		BRAKES-F			BRAKES-R			HAZ CHRG.	2.50
CUSTOMER'S SIGNATURE <i>Billy Abunoy</i>		BATTERY				SUB-LET	( )		
Warantee repairs based on guaranteed labor for this invoice must be performed at this location.		COOLANT				DEPOSIT			
						<b>TOTAL</b>	300.44		
REVISED ESTIMATE	PARTS 119.01	LABOR 170.00	TOTAL 291.51	DATE 08/21/98	TIME 3:13 PM	I ACKNOWLEDGE NOTICE AND ORAL APPROVAL OF AN INCREASE IN THE ORIGINAL ESTIMATED PRICE.			
BY	AUTHORIZED BY CUSTOMER BJ VANNDY		PHONE NO. 542-8070						

**SERVICE ORDER**

4207

SHILOH AUTO REPAIR 1244 CENTRAL AVE SANTA ROSA, CA 95401 BAR#AC138098 EPA#CAL717883347 523-4242		CUSTOMER NAME & ADDRESS L 393 AVE. SANTA ROSA, CA. 95409 (71 (70 19		DATE & TIME 4:57 PM 10/15/98	LABOR IS GUARANTEED FOR (WHICHEVER COMES FIRST) MILES: 2000 DAYS: 90
VEHICLE LICENSE NO. 2JHY101	ODOMETER 3894	VEHICLE DESCRIPTION 88 CHEVY SUBAN	VEHICLE IDENTIFICATION NO.	WRITTEN BY	DAILY STORAGE FEE AFTER 72 HOURS 15.00
PAYMENT METHOD ESTIMATE		CREDIT AUTHORIZATION		PROMISED 10/15/98	HOURLY LABOR RATE 64.92
<b>SERVICE REPAIR INSTRUCTIONS / SYMPTOMS</b>				<input type="checkbox"/> DELIVER <input type="checkbox"/> WILL CALL <input type="checkbox"/> PHONE WHEN READY	DIAGNOSTIC FEE 64.92
REPLACE HEATER HOSE				PREPARED BY	ALL PARTS ARE NEW UNLESS SPECIFIED AS USED(U) OR REBUILT(R)
				CERTIFIED BY	COMPUTER ESTIMATING SYSTEM ACCESS CHARGE

TECH.	QTY	PART NO.	REPAIR / SERVICE DESCRIPTION	PARTS	LABOR
	1	HEATER HOSES	REPLACE HEATER HOSE AS NEEDED HEATER HOSES (2.5)	6.50	15.00

*100  
200*

CUSTOMER REQUESTED RETURNED PARTS <input type="checkbox"/> YES <input type="checkbox"/> NO		<b>SAFETY RECOMMENDATIONS</b>				<b>TOTALS</b>				
I, the registered owner, authorize you to perform the above repairs and furnish necessary materials. I understand any cost quoted heretofore is an estimate only. Your employees may operate vehicle for inspection, testing, delivery at my risk. You will not be responsible for loss or damage to vehicle or articles left in it. I agree to pay reasonable storage on vehicle left more than 48 hours after notification that repairs are completed. An express Mechanic's Lien is acknowledged on above vehicle to secure the amount of repairs thereto, including those from any prior work or repair contract on this vehicle. In the event an attorney is retained to foreclose this lien or to bring suit for collection of any sums due, I agree to pay costs of collection and any reasonable attorney fees. Receipt of a copy of this order is hereby acknowledged.		<b>TIRES, BRAKES, BATTERY &amp; COOLANT</b>				LABOR	15.00			
						TIRES	RF	LF	RR	LR
		CUSTOMER'S SIGNATURE		TREAD					SALES TAX	0.49
		Warantee repairs based on guaranteed labor for this invoice must be performed at this location.		PSI					GASOLINE	
		BRAKES-F			BRAKES-R		SUB-LET	( )		
		BATTERY					DEPOSIT			
		COOLANT					<b>TOTAL</b>	21.99		
REVISED ESTIMATE	PARTS 6.50	LABOR 15.00	TOTAL 21.50	DATE	TIME	I ACKNOWLEDGE NOTICE AND ORAL APPROVAL OF AN INCREASE IN THE ORIGINAL ESTIMATED PRICE.				
BY	AUTHORIZED BY CUSTOMER		PHONE NO.							

# SERVICE ORDER

4330

SHILOH AUTO REPAIR 1244 CENTRAL AVE SANTA ROSA, CA 95401 BAR#AC138098 EPA#CAL717803347 523-4242		CUSTOMER NAME & ADDRESS [Blank]		DATE & TIME 3:47 PM 11/02/98 WRITTEN BY [Blank]		LABOR IS GUARANTEED FOR (WHICHEVER COMES FIRST) MILES: 6000 DAYS: 180	
VEHICLE LICENSE NO. 2THV101		ODOMETER 04169		VEHICLE DESCRIPTION 88 CHEVY SUBON		VEHICLE IDENTIFICATION NO. (707) - (707) -	
PAYMENT METHOD ESTIMATE		CREDIT AUTHORIZATION *		PROMISED 11/02/98		DAILY STORAGE FEE AFTER 72 HOURS 10.00	
SERVICE REPAIR INSTRUCTIONS / SYMPTOMS STEERING BOX, CHECK HOSES				<input type="checkbox"/> DELIVER <input type="checkbox"/> WILL CALL <input type="checkbox"/> PHONE WHEN READY		HOURLY LABOR RATE 64.92	
				PREPARED BY		DIAGNOSTIC FEE 64.92	
				CERTIFIED BY		ALL PARTS ARE NEW UNLESS SPECIFIED AS USED(U) OR REBUILT(R) COMPUTER ESTIMATING SYSTEM ACCESS CHARGE	

TECH.	QTY	PART NO.	REPAIR / SERVICE DESCRIPTION	PARTS	LABOR
	1	45220	REPLACED STEERING BOX 45220	251.80	181.78
	1	7-1782	7-1782 HOSE	30.90	
	1	7-1782	7-1782 HOSE	6.00	
	1	POWER STEE	POWER STEERING FLUID	2.50	
	1	HOSE CLAMPS	HOSE CLAMPS	3.00	

CUSTOMER REQUESTED RETURNED PARTS <input type="checkbox"/> YES <input type="checkbox"/> NO		SAFETY RECOMMENDATIONS				TOTALS			
I, the registered owner, authorize you to perform the above repairs and furnish necessary materials. I understand any cost quoted heretofore is an estimate only. Your employees may operate vehicle for inspection, testing, delivery at my risk. You will not be responsible for loss or damage to vehicle or articles left in it. I agree to pay reasonable storage on vehicle left more than 48 hours after notification that repairs are completed. An express Mechanic's Lien is acknowledged on above vehicle to secure the amount of repairs thereto, including those from any prior work or repair contract on this vehicle. In the event an attorney is retained to foreclose this lien or to bring suit for collection of any sums due, I agree to pay costs of collection and any reasonable attorney fees. Receipt of a copy of this order is hereby acknowledged.		TIRES, BRAKES, BATTERY & COOLANT		LABOR 181.78		PARTS 294.20			
		TIRES		TREAD		SALES TAX 22.87		GASOLINE	
		PSI		BRAKES-F		SUB-LET ( )		DEPOSIT	
		BRAKES-R		BATTERY COOLANT		TOTAL 498.85			
CUSTOMER'S SIGNATURE [Signature]		Warrantee repairs based on guaranteed labor for this invoice must be performed at this location.		I ACKNOWLEDGE NOTICE AND ORAL APPROVAL OF AN INCREASE IN THE ORIGINAL ESTIMATED PRICE.		[Signature]			
REVISSED ESTIMATE BY		PARTS 294.20		LABOR 181.78		TOTAL 475.98			
AUTHORIZED BY CUSTOMER [Signature]		DATE 11/02/98		TIME 3:47 PM		PHONE NO.			



NEW UNLESS OTHERWISE DESIGNATED

CODE N-NEW U-USED R-REBUILT

PART NO. OR DESCRIPTION

SALE

1 FH-29 8.90

1 Drain Valve Gasket 1.50

1 A41 Bush 2.00

1 CA336 Air Filter 10.50

1 FT TRAVS Filter Kit 12.95

2 16" Wipers 15.00

windsheild fluid 2.00

2025 ATF Coolant 3.00

1750

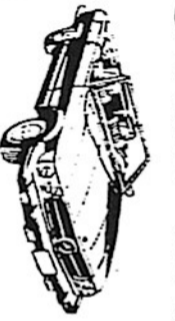

# TUNE-IN

CAR CARE & SERVICE... QUALITY REPAIR

1500 MENDOCINO AVENUE  
SANTA ROSA, CA 95404  
**(707) 542-8863**

ALL VEHICLES MUST BE PICKED UP WITHIN 1 DAY AFTER NOTIFICATION OF COMPLETION OF REPAIRS. . . . . UNLESS PREVIOUSLY ARRANGED A CHARGE OF \$20.00 PER DAY WILL BE MADE FOR STORAGE.

Service Order 28298

Year 88 Make Opel

Type or Model SUV

City S.R. State CA

Zip 95404

VEH I.D.#

License No 25T4Y101

Odomet 894255

ESTIMATE AMOUNT \$

REVISED AMOUNT

REVISED AMOUNT

DATE: TIME:  IN PERSON  PHONE

Authorized By: X

I ACKNOWLEDGE NOTICE AND ORAL APPROVAL OF AN INCREASE IN THE ORIGINAL ESTIMATED PRICE.

(Signature or Initials)

REPAIR ORDER LABOR INSTRUCTION

LAB. CHG. 10000

Car Care Service AOE

and Gasket Trans and Service Road Test

Replace Filter 3995

Pay by Cash

TOTAL PARTS

SUBLET REPAIRS

TOTAL LABOR 4995

PARTS 3985

SMOG CERTIFICATE HAZARDOUS WASTE 500

TOWING

SUBLET

RECOMMENDED SERVICE:

TOTAL 133.216 TAX 5416

TOTAL 133.216

Thank You!

BY LAW, YOU MAY CHOOSE ANOTHER AUTHORIZED FACILITY TO PERFORM ANY NEEDED REPAIRS OR ADJUSTMENTS WHICH THE SMOG CHECK TEST INDICATES ARE NECESSARY. A CUSTOMER WILL BE CHARGED FOR INSPECTION REGARDLESS OF PASS OR FAIL.

TOTAL PARTS	
SUBLET REPAIRS	
TOTAL LABOR	4995
PARTS	3985
SMOG CERTIFICATE HAZARDOUS WASTE	500
TOWING	
SUBLET	
RECOMMENDED SERVICE:	
TOTAL	133.216
TAX	5416
TOTAL	138.632

INTEREST WILL BE CHARGED AT A RATE OF 1 1/2% PER MONTH ON ACCOUNTS OVER 30 DAYS

• • • TERMS ARE CASH UNLESS OTHER PRIOR ARRANGEMENTS ARE MADE • • •

OFFICE COPY

ALL PARTS NEW UNLESS OTHERWISE DESIGNATED

★ CODE N-NEW U-USED R-REBUILT

QTY	★	PART NO. OR DESCRIPTION	SALE
7	OKS	39/50 oil	1750
1	PH29	oil filter	995
		washshield solvent	250
		codant	300
1	Ben	MRD153 pads	7180
		Brake fluid	300
		Brake clean	790
2		grease seals 897MS	1000
1		Grease seal 2081	1000

TOTAL PARTS 135 65

SUBLET REPAIRS

TOTAL SUBLET REPAIRS

INITIAL

RECOMMENDED SERVICE:

BY LAW, YOU MAY CHOOSE ANOTHER AUTHORIZED FACILITY TO PERFORM ANY NEEDED REPAIRS OR ADJUSTMENTS WHICH THE SMOG CHECK TEST INDICATES ARE NECESSARY. A CUSTOMER WILL BE CHARGED FOR INSPECTION REGARDLESS OF PASS OR FAIL.



# TUNE-IN

CAR CARE CENTER

1500 MENDOCINO AVENUE  
SANTA ROSA, CA 95404  
**(707) 542-8863**

QUALITY REPAIR & SERVICE

**ALL VEHICLES MUST BE PICKED UP WITHIN 1 DAY AFTER NOTIFICATION OF COMPLETION OF REPAIRS. . . . . UNLESS PREVIOUSLY ARRANGED A CHARGE OF \$20.00 PER DAY WILL BE MADE FOR STORAGE.**

Name \_\_\_\_\_ Date 1/2/97

Service Order 26354

L.O.F.
ROTATE TIRES
TUNE-UP
FUEL FILTER
TRANS. SERV.
DIFF. SERV.

Address \_\_\_\_\_

City \_\_\_\_\_

State \_\_\_\_\_

Zip \_\_\_\_\_

Year 88 Make Chevy Type or Model Suburban

Odometer 87543

Licenses 2 JHY 101

VEH I.D. # \_\_\_\_\_

ESTIMATE AMOUNT \$

REVISED AMOUNT

REVISED AMOUNT

REVISED AMOUNT

DATE: \_\_\_\_\_ TIME: \_\_\_\_\_

IN PERSON  PHONE

I hereby authorize the repair work below to be done along with necessary material, and hereby grant you and/or your employees permission to operate the car, truck or vehicle herein described on streets, highways or elsewhere for the purpose of testing and/or inspection. An express mechanic's lien is hereby acknowledged on above car, truck or vehicle to secure the amount of repairs thereto. You will not be held responsible for loss or damage to vehicle or articles left in the vehicle in case of fire, theft, accident or any other cause beyond your control.

Authorized By: **X**  
I ACKNOWLEDGE NOTICE AND ORAL APPROVAL OF AN INCREASE IN THE ORIGINAL ESTIMATED PRICE.  
(Signature or Initials)

REPAIR ORDER LABOR INSTRUCTION

Car Care Service ROF

LAB. CHG. 1000

Repair oil leak

ct. Rear and Brakes - Replace Front Brakes

② Rotors Turned

TOTAL LABOR	150 00
PARTS	135 65
SMOG CERTIFICATE HAZARDOUS WASTE	300
TOWING	
SUBLET	

TOTAL	298 83
TAX	10 18

----- Thank You!

INTEREST WILL BE CHARGED AT A RATE OF 1 1/2% PER MONTH ON ACCOUNTS OVER 30 DAYS

• • • TERMS ARE CASH UNLESS OTHER PRIOR ARRANGEMENTS ARE MADE • • •

OFFICE COPY

ALL PARTS NEW UNLESS OTHERWISE DESIGNATED

★ CODE N-NEW U-USED R-REBUILT

PART NO. OR DESCRIPTION

SALE

QTY	★	PART NO. OR DESCRIPTION	SALE
1		3510 ms Steaks License plate 9137D.4	<i>PK</i>



# TUNE-IN

CAR CARE CENTER

... QUALITY REPAIR & SERVICE ...



1500 MENDOCINO AVENUE  
SANTA ROSA, CA 95404  
**(707) 542-8863**

**ALL VEHICLES MUST BE PICKED UP WITHIN 1 DAY AFTER NOTIFICATION OF COMPLETION OF REPAIRS. . . . . UNLESS PREVIOUSLY ARRANGED A CHARGE OF \$20.00 PER DAY WILL BE MADE FOR STORAGE.**

Name *N* Date *6/10/97* SERVICE ORDER **27543**

Address *393 S. D. Ave* City *San* State *CA* Zip *95406* Year *88* Make *Chrysler* Type or Model *Suburban*

Odometer *91365* License No. *2FH Y101* VEH I.D. # *2580*

ESTIMATE AMOUNT \$  
REVISED AMOUNT  
REVISED AMOUNT

DATE: TIME:  IN PERSON  PHONE

I hereby authorize the repair work below to be done along with necessary material, and hereby grant you and/or your employees permission to operate the car, truck or vehicle herein described on streets, highways or elsewhere for the purpose of testing and/or inspection. An express mechanic's lien is hereby acknowledged on above car, truck or vehicle to secure the amount of repairs thereto. You will not be held responsible for loss or damage to vehicle or articles left in the vehicle in case of fire, theft, accident or any other cause beyond your control.

Authorized By: *X*

PHONE: *5280010*  
RES. *2580*  
BUS.  
Return Parts YES  NO

LAB. CHG. *PK*

REPAIR ORDER LABOR INSTRUCTION

*Replace Steaks*  
*Remove trans, Repair torque and*  
*Renshull*

TOTAL PARTS	TOTAL LABOR
	<i>25000</i>
SUBLET REPAIRS	

INITIAL HERE	TOTAL SUBLET REPAIRS

RECOMMENDED SERVICE:

TOTAL *25000*

BY LAW, YOU MAY CHOOSE ANOTHER AUTHORIZED FACILITY TO PERFORM ANY NEEDED REPAIRS OR ADJUSTMENTS WHICH THE SMOG CHECK TEST INDICATES ARE NECESSARY. A CUSTOMER WILL BE CHARGED FOR INSPECTION REGARDLESS OF PASS OR FAIL.

INSPECTION & REPAIR STA. #RC138098 • AC #AC138098  
★ ALL VEHICLES TESTED WILL BE CHARGED FOR PASS OR FAIL ★

----- Thank You!

INTEREST WILL BE CHARGED AT A RATE OF 1 1/2% PER MONTH ON ACCOUNTS OVER 30 DAYS

• • • TERMS ARE CASH UNLESS OTHER PRIOR ARRANGEMENTS ARE MADE • • •

ALL PARTS NEW UNLESS OTHERWISE DESIGNATED



# TUNE-IN

**CAR CARE CENTER**  
 1500 MENDOCINO AVENUE  
 SANTA ROSA, CA 95404  
**(707) 542-8863**

**ALL VEHICLES MUST BE PICKED UP WITHIN 1 DAY AFTER NOTIFICATION OF COMPLETION OF REPAIRS. . . . . UNLESS PREVIOUSLY ARRANGED A CHARGE OF \$20.00 PER DAY WILL BE MADE FOR STORAGE.**

L.O.F.

ROTATE TIRES

TUNE-UP

FUEL FILTER

TRANS. SERV.

DIFF. SERV.

QUALITY REPAIR & SERVICE

CAR CARE CENTER

Year	88
Make	CHEV
Type or Model	Suburban
Service Order	23805

Date: 3/6/96

Name: [blank]  
 Address: 2151 [blank]  
 City: Santa Rosa State: CA Zip: 95409  
 License No: JTHY 101

Odometer: 80837  
 ESTIMATE AMOUNT \$ 500.00

REVISED AMOUNT [blank]  
 REVISED AMOUNT [blank]  
 DATE: [blank] TIME: [blank]  IN PERSON  PHONE

REPAIR ORDER LABOR INSTRUCTION

LAB. CHG. [blank]

I hereby authorize the repair work below to be done along with necessary material, and hereby grant you and/or your employees permission to operate the car, truck or vehicle herein described on streets, highways or elsewhere for the purpose of testing and/or inspection. An express mechanic's lien is hereby acknowledged on above car, truck or vehicle to secure the amount of repairs thereto. You will not be held responsible for loss or damage to vehicle or articles left in the vehicle in case of fire, theft, accident or any other cause beyond your control.

Authorized By: X Betty Manley  
 I ACKNOWLEDGE NOTICE AND ORAL APPROVAL OF AN INCREASE IN THE ORIGINAL ESTIMATED PRICE:  
 (Signature or initials)  
 Return Parts: YES  NO

QTY	★ CODE N-NEW U-USED R-REBUILT	PART NO. OR DESCRIPTION	SALE
1		3510 MS Sticker	NYC
2		16-2 Wipers	2090
1		Trans S.I.Lv Kit Fluro	1270
1		6 Qts ATF	1200
1		6 Qts 10/30 oil	1350
1		PF 29 oil S.I.Lv	920
1		Idle Arm.	5353
8		NO. 24 spark plugs	2220
1		Dist cap DR 212	2550
1		Dist Rotor DR199	610
1		Suol S.I.Lv 63727	1962
2		Bottles Ing. cleaner	760
1		carb cleaner	790
1		par valve. P173	547
		TOTAL PARTS	251.22
		SUBLET REPAIRS	

Car Care Service				
Tune-up - Replace Sparkplugs,				180.00
Rotor, Cap, S.I.Lv and set to specs.				
Trans Servicing - Drain & Replace S.I.Lv				600.00
and Rosill and test drive truck				
Replace Idle Arm				50.00
Tire Repair (R)				15.00
Replace sticker warranties				NYC
TOTAL LABOR				225.00
PARTS				251.22
SMOG CERTIFICATE				
HAZARDOUS WASTE				4.00
TOWING				
SUBLET				
TOTAL				499.06
TAX				18.84

TOTAL → 499.06  
 TAX 18.84  
 ----- Thank You!

BY LAW, YOU MAY CHOOSE ANOTHER AUTHORIZED FACILITY TO PERFORM ANY NEEDED REPAIRS OR ADJUSTMENTS WHICH THE SMOG CHECK TEST INDICATES ARE NECESSARY. A CUSTOMER WILL BE CHARGED FOR INSPECTION REGARDLESS OF PASS OR FAIL.

INSPECTION & REPAIR STA. #RC138098 • AC #AC138098  
 ★ ALL VEHICLES TESTED WILL BE CHARGED FOR PASS OR FAIL ★

ALL PARTS NEW UNLESS OTHERWISE DESIGNATED

★ CODE N-NEW U-USED R-REBUILT

PART NO. OR DESCRIPTION

SALE

QTY	★	CODE N-NEW U-USED R-REBUILT	PART NO. OR DESCRIPTION	SALE
5			10/30 oil	
1			oil S.I.L.V. PH300	
8			NO. 303 sparkplugs 2720	



**TUNE-IN CAR CARE**  
**CENTER**  
 1500 MENDOCINO AVENUE  
 SANTA ROSA, CA 95404  
**(707) 542-8863**

**ALL VEHICLES MUST BE PICKED UP WITHIN 1 DAY AFTER NOTIFICATION OF COMPLETION OF REPAIRS. . . . . UNLESS PREVIOUSLY ARRANGED A CHARGE OF \$20.00 PER DAY WILL BE MADE FOR STORAGE.**

LAB. CHG.	
ROTATE TIRES	
TUNE-UP	
FUEL FILTER	
TRANS. SERV.	
DIFF. SERV.	

Name: *D. . . . .* Date: *3/28/96* SERVICE ORDER: *24021*

Address: *2425 . . . . .* City: *Santa Rosa* State: *CA* Zip: *95409*

Odometer: *38613* License No.: *768032* VEH I.D.#: *66* Make: *CHEV* Type or Model: *PV*

ESTIMATE AMOUNT \$

REVISED AMOUNT

REVISED AMOUNT

DATE: TIME:  IN PERSON  PHONE

Authorized By: *X B. Blumley*

REPAIR ORDER LABOR INSTRUCTION

*Car Care Service (CLOF)*

*CK Out - Replace sparkplugs 1000*

TOTAL PARTS

SUBLET REPAIRS

TOTAL SUBLET REPAIRS

RECOMMENDED SERVICE:

TOTAL LABOR	5000
PARTS	5215
SMOG CERTIFICATE HAZARDOUS WASTE	200
TOWING	
SUBLET	
TAX	391
<b>TOTAL</b>	<b>10506</b>

BY LAW, YOU MAY CHOOSE ANOTHER AUTHORIZED FACILITY TO PERFORM ANY NEEDED REPAIRS OR ADJUSTMENTS WHICH THE SMOG CHECK TEST INDICATES ARE NECESSARY. A CUSTOMER WILL BE CHARGED FOR INSPECTION REGARDLESS OF PASS OR FAIL.

INSPECTION & REPAIR STA. #RC138098 • AC #AC138098  
 ★ ALL VEHICLES TESTED WILL BE CHARGED FOR PASS OR FAIL ★

----- Thank You!

INTEREST WILL BE CHARGED AT A RATE OF 1 1/2% PER MONTH ON ACCOUNTS OVER 30 DAYS

• • • TERMS ARE CASH UNLESS OTHER PRIOR ARRANGEMENTS ARE MADE • • •

OFFICE COPY

ALL PARTS NEW UNLESS OTHERWISE DESIGNATED

★ CODE N-NEW U-USED R-REBUILT

PART NO. OR DESCRIPTION SALE



# TUNE-IN CAR CARE

... QUALITY REPAIR & SERVICE ...

1500 MENDOCINO AVENUE  
SANTA ROSA, CA 95404  
**(707) 542-8863**

ALL VEHICLES MUST BE PICKED UP WITHIN 1 DAY AFTER NOTIFICATION OF COMPLETION OF REPAIRS. . . . . UNLESS PREVIOUSLY ARRANGED A CHARGE OF \$20.00 PER DAY WILL BE MADE FOR STORAGE.

L.O.F.  
ROTATE TIRES  
TUNE-UP  
FUEL FILTER  
TRANS. SERV.  
DIFF. SERV.

Name: S. R. Sord Date: 6/20/92

Address: 24692 Year: 89

City: S.R. Ca State: 95404 Zip: 89 Sord

City: Santa Rosa State: Ca Zip: 95404

Odometer: 69942 License No.: 8M100487 VEH I.D.#:

ESTIMATE AMOUNT \$ 5000

REVISED AMOUNT

REVISED AMOUNT

DATE: TIME:  IN PERSON  PHONE

Authorized By: X B. J. Jammer

I hereby authorize the repair work below to be done along with necessary material, and hereby grant you and/or your employees permission to operate the car, truck or vehicle herein described on streets, highways or elsewhere for the purpose of testing and/or inspection. An express mechanic's lien is hereby acknowledged on above car, truck or vehicle to secure the amount of repairs thereto. You will not be held responsible for loss or damage to vehicle or articles left in the vehicle in case of fire, theft, accident or any other cause beyond your control.

I ACKNOWLEDGE NOTICE AND ORAL APPROVAL OF AN INCREASE IN THE ORIGINAL ESTIMATED PRICE.

(Signature or Initials)

REPAIR ORDER LABOR INSTRUCTION

Resur Face Rotor

LAB. CHG. 5000

PHONE: RES. BUS. Return Parts YES  NO

Type or Model: Escort

TOTAL PARTS	
SUBLET REPAIRS	
TOTAL LABOR	<u>5000</u>
TOTAL	<u>5000</u>
TAX	
TOTAL SUBLET REPAIRS	
RECOMMENDED SERVICE:	

BY LAW, YOU MAY CHOOSE ANOTHER AUTHORIZED FACILITY TO PERFORM ANY NEEDED REPAIRS OR ADJUSTMENTS WHICH THE SMOG CHECK TEST INDICATES ARE NECESSARY. A CUSTOMER WILL BE CHARGED FOR INSPECTION REGARDLESS OF PASS OR FAIL.

INSPECTION & REPAIR STA. #RC138098 • AC #AC138098  
★ ALL VEHICLES TESTED WILL BE CHARGED FOR PASS OR FAIL ★

TOTAL 5000  
Thank You!

ALL PARTS NEW UNLESS OTHERWISE DESIGNATED

★ CODE N-NEW U-USED R-REBUILT

PART NO. OR DESCRIPTION

SALE

1	PH 29 oil 5-11L	8895
2	oil 19/30	

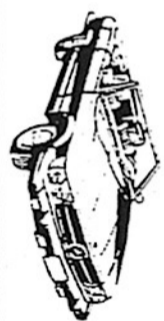

# TUNE-IN

**CAR CARE CENTER**  
1500 MENDOCINO AVENUE  
SANTA ROSA, CA 95404  
**(707) 542-8863**

ALL VEHICLES MUST BE PICKED UP WITHIN 1 DAY AFTER NOTIFICATION OF COMPLETION OF REPAIRS. . . . . UNLESS PREVIOUSLY ARRANGED A CHARGE OF \$20.00 PER DAY WILL BE MADE FOR STORAGE.

L.O.F.   
ROTATE TIRES  
TUNE-UP  
FUEL FILTER  
TRANS. SERV.  
DIFF. SERV.

Name: *Pull*

Date: *7/24/96*

Service Order: *24955*

Year: *88*

Make or Model: *Chery SUB*

Address: *Santa Rosa, CA 95409*

City: *Santa Rosa, CA*

Year: *88*

Make or Model: *Chery SUB*

Odometer: *65640*

VEH I.D. #

Year: *88*

Make or Model: *Chery SUB*

License No.: *85H412*

VEH I.D. #

Year: *88*

Make or Model: *Chery SUB*

ESTIMATE AMOUNT \$ *2895*

REVISED AMOUNT

REVISED AMOUNT

DATE: TIME:  IN PERSON  PHONE

Authorized By: *X B J N M*

REPAIR ORDER LABOR INSTRUCTION: *Car Care Service*

LAB. CHG. *1/2*

TOTAL PARTS	
SUBLET REPAIRS	
TOTAL SUBLET REPAIRS	

*Part Built*

RECOMMENDED SERVICE:

*Exhaust Part  
Carrier Bearing - U-Joint  
Front Brakes*

BY LAW, YOU MAY CHOOSE ANOTHER AUTHORIZED FACILITY TO PERFORM ANY NEEDED REPAIRS OR ADJUSTMENTS WHICH THE SMOG CHECK TEST INDICATES ARE NECESSARY. A CUSTOMER WILL BE CHARGED FOR INSPECTION REGARDLESS OF PASS OR FAIL.

INSPECTION & REPAIR STA. #RC138098 • AC #AC138098

TOTAL LABOR	<i>176</i>
PARTS	<i>2895</i>
SMOG CERTIFICATE HAZARDOUS WASTE	<i>200</i>
TOWING	
SUBLET	
TAX	<i>217</i>
<b>TOTAL</b>	<b><i>3312</i></b>

----- Thank You!

INTEREST WILL BE CHARGED AT A RATE OF 1 1/2% PER MONTH ON ACCOUNTS OVER 30 DAYS

• • • TERMS ARE CASH UNLESS OTHER PRIOR ARRANGEMENTS ARE MADE • • •

OFFICE COPY

ALL PARTS NEW UNLESS OTHERWISE DESIGNATED

QTY	PART NO. OR DESCRIPTION	SALE
1	Battery Engl	350
1	Voltage Regulator	4716

INITIAL HERE	TOTAL SUBLET REPAIRS
	TOTAL PARTS
	SUBLET REPAIRS

BY LAW, YOU MAY CHOOSE ANOTHER AUTHORIZED FACILITY TO PERFORM ANY NEEDED REPAIRS OR ADJUSTMENTS WHICH THE SMOG CHECK TEST INDICATES ARE NECESSARY. A CUSTOMER WILL BE CHARGED FOR INSPECTION REGARDLESS OF PASS OR FAIL.



# TUNE-IN

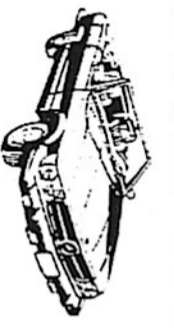

CAR CARE & SERVICE... QUALITY REPAIR CENTER

1500 MENDOCINO AVENUE  
SANTA ROSA, CA 95404  
(707) 542-8863

ALL VEHICLES MUST BE PICKED UP WITHIN 1 DAY AFTER NOTIFICATION OF COMPLETION OF REPAIRS. . . . . UNLESS PREVIOUSLY ARRANGED A CHARGE OF \$20.00 PER DAY WILL BE MADE FOR STORAGE.

Name: 0-11 Date: 8/16/96 SERVICE ORDER: 25254

Address: Santa Rosa City: Santa Rosa State: CA Year: 88

Odometer: 85,000 License No: 2JH4101 VEH I.D.#: 954079 Make: Chrysler

ESTIMATE AMOUNT \$            Type or Model: Suburban

REVISED AMOUNT            REVISED AMOUNT            PHONE:           

DATE:            TIME:             IN PERSON  PHONE            BUS.           

Authorized By: X Billy & Marjorie Return Parts YES  NO

(Signature or Initials)

REPAIR ORDER LABOR INSTRUCTION

Repair Alternator 9000  
Replace Battery cable Engl. 1200

RECOMMENDED SERVICE:	LAB. CHG.
TOTAL LABOR	102.00
PARTS	5066
SMOG CERTIFICATE	
HAZARDOUS WASTE	
TOWING	
SUBLET	
TAX	380
TOTAL	15646

INSPECTION & REPAIR STA. #RC138098 • AC #AC138098  
★ ALL VEHICLES TESTED WILL BE CHARGED FOR PASS OR FAIL ★

----- Thank You!

INTEREST WILL BE CHARGED AT A RATE OF 1 1/2% PER MONTH ON ACCOUNTS OVER 30 DAYS

• • • TERMS ARE CASH UNLESS OTHER PRIOR ARRANGEMENTS ARE MADE • • •

OFFICE COPY



ALL PARTS NEW UNLESS OTHERWISE DESIGNATED

★ CODE N-NEW U-USED R-REBUILT

QTY	PART NO. OR DESCRIPTION	SALE
1	used D.S. serpentine belt	35000
2	Seals 58335 5	980
4	pls gear oil	2300
1	Gascock	1428
1	Bake Slurid	300
1	Cleaner	790
TOTAL PARTS		
SUBLET REPAIRS		

*Paul  
R. [Signature]*



**TUNE-IN**  
CAR CARE  
CENTER  
1500 MENDOCINO AVENUE  
SANTA ROSA, CA 95404  
(707) 542-8863

ALL VEHICLES MUST BE PICKED UP WITHIN 1 DAY AFTER NOTIFICATION OF COMPLETION OF REPAIRS. . . . . UNLESS PREVIOUSLY ARRANGED A CHARGE OF \$20.00 PER DAY WILL BE MADE FOR STORAGE.

Date: 12/4/96

Service Order: 26178

LO.F.	
ROTATE TIRES	
TUNE-UP	
FUEL FILTER	
TRANS. SERV.	
DIFF. SERV.	

Name: [Blank]  
Address: 303 [Blank]  
City: Santa Rosa, CA State: CA Zip: 95404  
Odometer: 39183 License No. T68032 VEH ID.# [Blank]

ESTIMATE AMOUNT \$

REVISED AMOUNT

REVISED AMOUNT

DATE: TIME:  IN PERSON  PHONE

I hereby authorize the repair work below to be done along with necessary material, and hereby grant you and/or your employees permission to operate the car, truck or vehicle herein described on streets, highways or elsewhere for the purpose of testing and/or inspection. An express mechanic's lien is hereby acknowledged on above car, truck or vehicle to secure the amount of repairs thereto. You will not be held responsible for loss or damage to vehicle or articles left in the vehicle in case of fire, theft, accident or any other cause beyond your control.

Authorized By: [Signature] X

I ACKNOWLEDGE NOTICE AND ORAL APPROVAL OF AN INCREASE IN THE ORIGINAL ESTIMATED PRICE.

Return Parts YES  NO

REPAIR ORDER LABOR INSTRUCTION

Replace Rear D. Serpentine belt  
and install new seals,  
Repayment 1 clean brake system + Slush

LAB. CHG.

RECOMMENDED SERVICE:

TOTAL LABOR	30000
PARTS	40798
SMOG CERTIFICATE	
HAZARDOUS WASTE	200
TOWING	
SUBLET	
TAX	3060
<b>TOTAL</b>	<b>74058</b>

12-20-96  
PAID CHECK 01112 - \$350.00  
BALANCE \$39058

BY LAW, YOU MAY CHOOSE ANOTHER AUTHORIZED FACILITY TO PERFORM ANY NEEDED REPAIRS OR ADJUSTMENTS WHICH THE SMOG CHECK TEST INDICATES ARE NECESSARY. A CUSTOMER WILL BE CHARGED FOR INSPECTION REGARDLESS OF PASS OR FAIL.

INSPECTION & REPAIR STA. #RC138098 • AC #AC138098  
★ ALL VEHICLES TESTED WILL BE CHARGED FOR PASS OR FAIL ★

Thank You!

INTEREST WILL BE CHARGED AT A RATE OF 1 1/2% PER MONTH ON ACCOUNTS OVER 30 DAYS

• • • TERMS ARE CASH UNLESS OTHER PRIOR ARRANGEMENTS ARE MADE • • •

OFFICE COPY

ALL PARTS NEW UNLESS OTHERWISE DESIGNATED

★ CODE N-NEW U-USED R-REBUILT

QTY	PART NO. OR DESCRIPTION	SALE
1	MTD 153 Brake pads	6988
	Brake clevis	790
	Brake Stud	700
	Seals	1600



# TUNE-IN

CAR CARE CENTER  
1500 MENDOCINO AVENUE  
SANTA ROSA, CA 95404  
(707) 542-8863

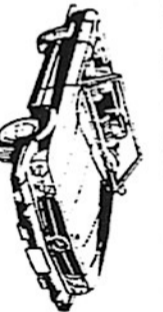

ALL VEHICLES MUST BE PICKED UP WITHIN 1 DAY AFTER NOTIFICATION OF COMPLETION OF REPAIRS. . . . . UNLESS PREVIOUSLY ARRANGED A CHARGE OF \$20.00 PER DAY WILL BE MADE FOR STORAGE.

Service Order: 21558

LOF.	
ROTATE TIRES	
TUNE-UP	
FUEL FILTER	
TRANS. SERV.	
DIFF. SERV.	

Name: \_\_\_\_\_ Date: 8/2/95

Address: \_\_\_\_\_

City: Santa Rosa State: CA License No: 22747101

Odometer: 24516 VEH I.D. #: 25409

Year: 88 Make: Chevy Type or Model: Cobalt

ESTIMATE AMOUNT \$ 200.00

REVISED AMOUNT

REVISED AMOUNT

DATE: \_\_\_\_\_ TIME: \_\_\_\_\_

IN PERSON  PHONE

REPAIR ORDER LABOR INSTRUCTION

LAB. CHG. 75

I hereby authorize the repair work below to be done along with necessary material, and hereby grant you and/or your employees permission to operate the car, truck or vehicle herein described on streets, highways or elsewhere for the purpose of testing and/or inspection. An express mechanic's lien is hereby acknowledged on above car, truck or vehicle to secure the amount of repairs thereto. You will not be held responsible for loss or damage to vehicle or articles left in the vehicle in case of fire, theft, accident or any other cause beyond your control.

Authorized By: *X B. Williams*

I ACKNOWLEDGE NOTICE AND ORAL APPROVAL OF AN INCREASE IN THE ORIGINAL ESTIMATED PRICE.

(Signature or Initials)

PHONE: 2170

RES:

BUS:

Return Parts YES  NO

Brake ok

Replace Front Brakes Repack wheel 2000

clean Rear Brake system.

2 Rotors Tuned 3600

TOTAL PARTS	106.00
SUBLET REPAIRS	100.78
TOTAL LABOR	2000
TOTAL	3600
TAX	75.60
TOTAL	3675.60

BY LAW, YOU MAY CHOOSE ANOTHER AUTHORIZED FACILITY TO PERFORM ANY NEEDED REPAIRS OR ADJUSTMENTS WHICH THE SMOG CHECK TEST INDICATES ARE NECESSARY. A CUSTOMER WILL BE CHARGED FOR INSPECTION REGARDLESS OF PASS OR FAIL.

INSPECTION & REPAIR STA. #RC138098 • AC #AC138098

★ ALL VEHICLES TESTED WILL BE CHARGED FOR PASS OR FAIL ★

TOTAL 3675.60

Thank You!

INTEREST WILL BE CHARGED AT A RATE OF 1 1/2% PER MONTH ON ACCOUNTS OVER 30 DAYS

• • • TERMS ARE CASH UNLESS OTHER PRIOR ARRANGEMENTS ARE MADE • • •

OFFICE COPY

ALL PARTS NEW UNLESS OTHERWISE DESIGNATED

★ CODE N-NEW U-USED R-REBUILT

PART NO. OR DESCRIPTION

SALE

QTY	★	PART NO. OR DESCRIPTION	SALE
1	15-	4593 Fan clutch	17816



# TUNE-IN CAR CARE CENTER

1500 MENDOCINO AVENUE  
SANTA ROSA, CA 95404  
**(707) 542-8863**

ALL VEHICLES MUST BE PICKED UP WITHIN 1 DAY AFTER NOTIFICATION OF COMPLETION OF REPAIRS. . . . . UNLESS PREVIOUSLY ARRANGED A CHARGE OF \$20.00 PER DAY WILL BE MADE FOR STORAGE.

LO.F.	
ROTATE TIRES	
TUNE-UP	
FUEL FILTER	
TRANS. SERV.	
DIFF. SERV.	

Name

Address

City

Odometer

State

License No.

VEH I.D. #

Year

Make

Service Order

Date

Zip

21985

88 Chevy

9/8/95

Suburban

76219

CA

95404

ESTIMATE AMOUNT \$

REVISED AMOUNT

REVISED AMOUNT

DATE:

TIME:

IN PERSON

PHONE

LAB. CHG.

5000

Replace Fan clutch

Authorized By:

I ACKNOWLEDGE NOTICE AND ORAL APPROVAL OF AN INCREASE IN THE ORIGINAL ESTIMATE PRICE.

Signature or Initials

PHONE:

RES.

BUS.

Return Parts

YES  NO

LAB. CHG.

5000

TOTAL PARTS	17816
SUBLET REPAIRS	
TOTAL SUBLET REPAIRS	

TOTAL LABOR	50 00
PARTS	178 16
SMOG CERTIFICATE	
HAZARDOUS WASTE	
TOWING	
SUBLET	
TOTAL	241 59
TAX	13 36

RECOMMENDED SERVICE:

INSPECTION & REPAIR STA. #RC138098 • AC #AC138098

★ ALL VEHICLES TESTED WILL BE CHARGED FOR PASS OR FAIL ★

----- Thank You!

BY LAW, YOU MAY CHOOSE ANOTHER AUTHORIZED FACILITY TO PERFORM ANY NEEDED REPAIRS OR ADJUSTMENTS WHICH THE SMOG CHECK TEST INDICATES ARE NECESSARY. A CUSTOMER WILL BE CHARGED FOR INSPECTION REGARDLESS OF PASS OR FAIL.

ALL PARTS NEW UNLESS OTHERWISE DESIGNATED

★ CODE N-NEW U-USED R-REBUILT

PART NO. OR DESCRIPTION

SALE

1 2510 S skelby

61600



# TUNE-IN

CAR CARE CENTER

... QUALITY REPAIR & SERVICE ...



1500 MENDOCINO AVENUE  
SANTA ROSA, CA 95404  
**(707) 542-8863**

ALL VEHICLES MUST BE PICKED UP WITHIN 1 DAY AFTER NOTIFICATION OF COMPLETION OF REPAIRS. ... UNLESS PREVIOUSLY ARRANGED A CHARGE OF \$20.00 PER DAY WILL BE MADE FOR STORAGE.

Name

Address

City

State

Zip

Date 11/26/85

SERVICE ORDER 22608

Type or Model

Year 88

Make Chevy

Suburban

Odometer 77052

License No. 2JHY 101

VEH I.D. #

PHONE:

RES.

BUS.

I hereby authorize the repair work below to be done along with necessary material, and hereby grant you and/or your employees permission to operate the car, truck or vehicle herein described on streets, highways or elsewhere for the purpose of testing and/or inspection. An express mechanic's lien is hereby acknowledged on above car, truck or vehicle to secure the amount of repairs thereto. You will not be held responsible for loss or damage to vehicle or articles left in the vehicle in case of fire, theft, accident or any other cause beyond your control.

ESTIMATE AMOUNT \$

REVISED AMOUNT

REVISED AMOUNT

DATE:

TIME:

IN PERSON

PHONE

I ACKNOWLEDGE NOTICE AND ORAL APPROVAL OF AN INCREASE IN THE ORIGINAL ESTIMATED PRICE.

Authorized By: X

(Signature or Initials)

REPAIR ORDER LABOR INSTRUCTION

Replace Sparkler

LAB. CHG. 4000

*Paul J. ...*

TOTAL PARTS

SUBLET REPAIRS

TOTAL SUBLET REPAIRS

RECOMMENDED SERVICE:

TAX

TOTAL

TOTAL LABOR 4000

PARTS 61600

SMOG CERTIFICATE HAZARDOUS WASTE

TOWING

SUBLET

4000

10600

Thank You!

BY LAW, YOU MAY CHOOSE ANOTHER AUTHORIZED FACILITY TO PERFORM ANY NEEDED REPAIRS OR ADJUSTMENTS WHICH THE SMOG CHECK TEST INDICATES ARE NECESSARY. A CUSTOMER WILL BE CHARGED FOR INSPECTION REGARDLESS OF PASS OR FAIL.

INSPECTION & REPAIR STA. #RC138098 • AC #AC138098  
★ ALL VEHICLES TESTED WILL BE CHARGED FOR PASS OR FAIL ★

INTEREST WILL BE CHARGED AT A RATE OF 1 1/2% PER MONTH ON ACCOUNTS OVER 30 DAYS

• • • TERMS ARE CASH UNLESS OTHER PRIOR ARRANGEMENTS ARE MADE • • •

OFFICE COPY



SMOG INSPECTION AND REPAIR SPECIALISTS

V.A.C.

1500 MENDOCINO AVENUE  
SANTA ROSA, CA 95401  
(707) 542-8863

CENTER

20799

INSPECTION & REPAIR STA. #RC138098 • AC #AC138098

NAME <i>Ben Van Roy</i>	PHONE-HOME (BUSINESS) <i>u</i>	YEAR, MAKE & MODEL <i>88 Chevy Suburban</i>	DATE <i>6-7-95</i>
ADDRESS <i>700 -</i>	CITY <i>S.R</i>	STATE <i>CA</i>	TIME <i>7:15 AM</i>
ODOMETER READING <i>73,000</i>	LICENSE NO. <i>2JHY101</i>	VIN	GVW (TRUCK ONLY)

**PARTS** ALL PARTS ARE NEW UNLESS OTHERWISE INDICATED      **LABOR**      **DESCRIPTION OF SERVICE AND OR ADJUSTMENT**

QTY.	PART NUMBER OR DESCRIPTION	AMOUNT	DESCRIPTION	AMOUNT
1	A/c Compressor <i>57273</i>	370.19	<input type="checkbox"/> I/M SMOG INSPECTION (PASS OR FAIL)	
1	Accumulator <i>33183</i>	79.22	<input type="checkbox"/> I/M SMOG CERTIFICATE	
	O-Rings	7.35	<input type="checkbox"/> LOW EMISSION SERVICE/ADJUSTMENTS	
6oz	A/c Oil	11.70	<input type="checkbox"/> ADJ DWELL <input type="checkbox"/> ADJ TIMING <input type="checkbox"/> ADJ CARBURETOR OR F.I.	
5/2	Freon	115.50	<input type="checkbox"/> RETEST	
	A/c Hose	146.96	<i>A/c Repair - Replace A/c Compressor &amp; High &amp; low side hoses O-Rings and Expansion tube and Replace Accumulator.</i>	
	Expansion tube	9.90		
<i>Pay by</i>			<input type="checkbox"/> ENGINE TUNE-UP	<input type="checkbox"/> SCOPE SERVICE (MIN. \$20)
<i>and check. 8922#</i>				
<i>\$600.00</i>		TOTAL PARTS		

NOTE: ACTUAL COST MAY BE LOWER THAN OUR ESTIMATE.

I hereby authorize the indicated repair work to be done along with necessary materials. You and your employees may operate vehicle for purposes of testing, inspection or delivery at my risk. An express mechanic's lien is acknowledged on vehicle to secure the amount of repairs thereto. You will not be held responsible for loss or damage to vehicle or articles left in vehicle in case of fire, theft, accident or any other cause beyond your control.

BY LAW, YOU MAY CHOOSE ANOTHER SMOG SHOP TO PERFORM ANY NEEDED REPAIRS OR ADJUSTMENTS WHICH THE SMOG CHECK TEST INDICATES ARE NECESSARY.

INITIAL ESTIMATE

\$ \_\_\_\_\_

DO YOU WANT THE OLD PARTS?  
YES  NO

*X* *Ben Van Roy*  
CUSTOMER'S SIGNATURE

ADDITIONAL REPAIR AUTHORIZATION

ESTIMATED COST OF ADDITIONAL REPAIRS

\$ \_\_\_\_\_

I ACKNOWLEDGE NOTICE AND ORAL APPROVAL OF AN INCREASE IN THE ORIGINAL ESTIMATED PRICE.

*X* \_\_\_\_\_  
CUSTOMER'S SIGNATURE

TELEPHONE AUTHORIZATION

DATE \_\_\_\_\_ TELEPHONE NO. CALLED \_\_\_\_\_  
TIME \_\_\_\_\_ NAME OF PERSON AUTHORIZING \_\_\_\_\_

SUB TOTAL	
TOTAL LABOR	<i>36000</i>
TOTAL PARTS	<i>740.82</i>
SALES TAX	<i>55.56</i>
TOTAL AMOUNT	<i>15638</i>

Thank You!

CUSTOMER'S INVOICE

**PROTECH Repair Order**



P 069184

QTY.	PART NO. / DESCRIPTION	AMOUNT
PARTS ARE NEW UNLESS SPECIFIED OTHERWISE		
2	2600-1312 Ball joints	9252
2	26817 Shocks	111 48
2	26824 Shocks	111 48
1	Idler Arm, 26839	24 36

**DEALER**  
**MONTGOMERY 76**  
 4357 Montgomery Drive  
 Santa Rosa, CA 95405 SS#5495  
 (707) 539-7600 **BAR #AG111246**  
 EPA# CAL000005615

**CUSTOMER'S NAME** \_\_\_\_\_  
**ADDRESS** \_\_\_\_\_  
**CITY, STATE, ZIP CODE** Santa Rosa CA 95409  
**RESIDENTIAL PHONE** \_\_\_\_\_  **PHONE WHEN READY**

**REPAIR ORDER / LABOR INSTRUCTION**

RRR Ball joints & and Idle Arm.  
 Rube front End.  
 RRR @ Shocks  
 Alignment

TOTAL PARTS	AMOUNT
TOTAL OIL AND GREASE	
QTS. OIL - TYPE SAE	
QTS. ATF - TYPE	
GALS. COOLANT / ANTIFREEZE	
<input type="checkbox"/> LBS. GREASE <input type="checkbox"/> PTS. GEAR OIL	
TOTAL OIL AND GREASE	
<b>SUBLET REPAIRS</b>	<b>AMOUNT</b>
TOTAL SUBLET REPAIRS	

**REPLACED PARTS REQUESTED BY CUSTOMER**  YES  NO

I, the registered owner, authorize you to perform the above repairs and furnish necessary materials. I understand any cost quoted heretofore is an estimate only. Your employees may operate vehicle for inspection, testing, delivery at my risk. You will not be responsible for loss or damage to vehicle or articles left in it. I agree to pay reasonable storage on vehicle left more than 48 hours after notification that repairs are completed. An express mechanic's lien is acknowledged on above vehicle to secure the amount of repairs thereto, including those from any prior work or repair contract on this vehicle. In the event an attorney is retained to foreclose this lien or to bring suit for collection of any sums due, I agree to pay costs of collection and any reasonable attorney fees. Receipt of a copy of this order is hereby acknowledged.

Customer's signature Barry M. May

**MAY WE RECOMMEND**

ESTIMATE AMOUNT		REVISED ESTIMATE	
LABOR	PARTS	LABOR	PARTS
178.00	178.00	308.95	308.95
250.00	58.00	389.94	389.94
00.00	22.95		
<b>TOTALS</b>			

By law, you may choose another facility to perform any needed repairs or adjustments which the Smog Check test indicates are necessary.

FORM 3-4H76 (REV. 2-92) PRINTED IN U.S.A.

**DATE** 7-11-94 **AM**  
**PROMISED** 12 MO./12,000 MI.  
**WRITTEN BY** GAB  
**VEHICLE YEAR & MAKE** 88 Chevy  
**MODEL** Suburban  
**LICENSE NO.** 877HYD1  
**ODOMETER READING** 62753

**THE 76 PROTECH WARRANTY APPLIES TO THE FOLLOWING ITEMS AS CHECKED:**  
 TUNE-UP/EMISSION  
 12 MO./12,000 MI.  
 BRAKE OVERHAUL  
 24 MO./24,000 MI.  
 BRAKE SERVICE  
 12 MO./12,000 MI.  
 WHEEL ALIGNMENT  
 12 MO./12,000 MI.  
 AIR CONDITIONING  
 4 MO./4,000 MI.  
 OTHER PARTS/SERVICE  
 4 MO./4,000 MI.

**REWORKED BY** GAB **CERTIFIED TECHNICIAN**

**SALES TAX** 29.24  
**GASOLINE**  
**TOTAL** 728.03

QTY. PART NO. / DESCRIPTION AMOUNT

PARTS ARE NEW UNLESS SPECIFIED OTHERWISE

1	starter	28.00
1	water pump	26.60
2	3/4" hose clamps	3.00
1	2 1/8" hose clamp	13.50
1/4	oil pan	5.00
1	steering rack leavers	9.00
1	steering rack offset 1540	17.85
1	AC belt 15610	

*Handwritten signature*

**UNOCAL** 76

**PROTECH** Repair Order

P 068949

DEALER

MONTGOMERY 76  
4357 Montgomery Drive  
Santa Rosa, CA 95405 SS#5495  
(707) 539-7600 BAR #AG111246  
EPA# CAL000005615

CUSTOMER NAME

*Handwritten name*

ADDRESS

Santa Rosa, CA 95409

CITY, STATE, ZIP CODE

RESIDENCE PHONE

TECH.

REPAIR ORDER / LABOR INSTRUCTION

*Handwritten notes:*  
Bumpy start - runs OK ✓ Battery?  
call at 528-5540  
replace starter  
replace water pump

TOTAL PARTS 210.15

REPLACED PARTS REQUESTED BY CUSTOMER  YES  NO

ESTIMATE AMOUNT

TOTALS

OIL AND GREASE  
QTS. OIL - TYPE SAE  
QTS. ATF - TYPE  
GALS. COOLANT / ANTIFREEZE  
 LBS. GREASE  PTS. GEAR OIL

REPLACED PARTS REQUESTED BY CUSTOMER  YES  NO  
I, the registered owner, authorize you to perform the above repairs and furnish necessary materials. I understand any cost quoted heretofore is an estimate only. Your employees may operate vehicle for inspection, testing, delivery at my risk. You will not be responsible for loss or damage to vehicle or articles left in it. I agree to pay reasonable storage on vehicle left more than 48 hours after notification that repairs are completed. An express Mechanic's Lien is acknowledged on above vehicle to secure the amount of repairs hereon, including those from any prior work or repair contract on this vehicle. In the event an attorney is retained to foreclose this lien or to bring suit for collection of any sums due, I agree to pay costs of collection and any reasonable attorney fees. Receipt of a copy of this order is hereby acknowledged.

DATE 10/26/94  
AUTHORIZED BY (CUSTOMER) B.J. van der ...  
PHONE NO. 528-5540

LABOR 121.40  
PARTS 210.15  
OIL, GREASE 5.00  
AUTOCARE INVOICE NO.

TOTAL OIL AND GREASE  
SUBLET REPAIRS AMOUNT

CUSTOMER'S SIGNATURE *Handwritten signature*  
MAY WE RECOMMEND

DATE 10/26/94  
AUTHORIZED BY (CUSTOMER) B.J. van der ...  
PHONE NO. 528-5540

SALES TAX 15.26  
GASOLINE 422.87  
TOTAL 422.87

FORM 3-4H76 (REV. 2-92) PRINTED IN U.S.A.

WARRANTY AND POLICY INFORMATION ARE PRINTED ON THE BACK OF THIS FORM.

THE 76 PROTECH WARRANTY APPLIES TO THE FOLLOWING ITEMS AS CHECKED.  
 TUNE-UP / EMISSION  
 12 MO. / 12,000 MI.  
 BRAKE OVERHAUL  
 24 MO. / 24,000 MI.  
 BRAKE SERVICE  
 12 MO. / 12,000 MI.  
 WHEEL ALIGNMENT  
 12 MO. / 12,000 MI.  
 AIR CONDITIONING  
 4 MO. / 4,000 MI.  
 OTHER PARTS / SERVICE  
 4 MO. / 4,000 MI.

ATTACH PART MANUFACTURER'S WARRANTY TO THIS FORM

ORIGINAL CUSTOMER INVOICE