

2010 Porsche Boxster S







VIN: WPOCB2A89AU730183





Vehicle History Report™

US \$39.99

2010 PORSCHE BOXSTER S VIN: WP0CB2A89AU730183 CONVERTIBLE 3.4L H6 F GASOLINE REAR WHEEL DRIVE	<input checked="" type="checkbox"/>	No accidents or damage reported to CARFAX	
		3 Previous owners	
		22 Service history records	
		Types of owners: Corporate, Personal	
		Last owned in California	
		33,489 Last reported odometer reading	

This CARFAX Vehicle History Report is based only on information supplied to CARFAX and available as of 9/22/21 at 6:52:04 PM (CDT). Other information about this vehicle, including problems, may not have been reported to CARFAX. Use this report as one important tool, along with a vehicle inspection and test drive, to make a better decision about your next used car.

CARFAX Ownership History	Owner 1	Owner 2	Owner 3
The number of owners is estimated			
Year purchased	2009	2013	2018
Type of owner	Corporate	Personal	Personal
Estimated length of ownership	3 yrs. 7 mo.	4 yrs. 8 mo.	3 yrs. 3 mo.
Owned in the following states/provinces	California	California	California
Estimated miles driven per year	4,270/yr	3,383/yr	1,340/yr
Last reported odometer reading	15,515	27,392	33,489

CARFAX Title History	Owner 1	Owner 2	Owner 3
CARFAX guarantees the information in this section			
Salvage Junk Rebuilt Fire Flood Hail Lemon	<input checked="" type="checkbox"/> Guaranteed No Problem	<input checked="" type="checkbox"/> Guaranteed No Problem	<input checked="" type="checkbox"/> Guaranteed No Problem
Not Actual Mileage Exceeds Mechanical Limits	<input checked="" type="checkbox"/> Guaranteed No Problem	<input checked="" type="checkbox"/> Guaranteed No Problem	<input checked="" type="checkbox"/> Guaranteed No Problem



GUARANTEED - None of these major title problems were reported by a state Department of Motor Vehicles (DMV). If you find that any of these title problems were reported by a DMV and not included in this report, CARFAX will buy this vehicle back. [Register](#) | [View Terms](#) | [View Certificate](#)

CARFAX Additional History	Owner 1	Owner 2	Owner 3
Not all accidents / issues are reported to CARFAX			
Total Loss No total loss reported to CARFAX.	<input checked="" type="checkbox"/> No Issues Reported	<input checked="" type="checkbox"/> No Issues Reported	<input checked="" type="checkbox"/> No Issues Reported
Structural Damage No structural damage reported to CARFAX.	<input checked="" type="checkbox"/> No Issues Reported	<input checked="" type="checkbox"/> No Issues Reported	<input checked="" type="checkbox"/> No Issues Reported
Airbag Deployment No airbag deployment reported to CARFAX.	<input checked="" type="checkbox"/> No Issues Reported	<input checked="" type="checkbox"/> No Issues Reported	<input checked="" type="checkbox"/> No Issues Reported
Odometer Check No indication of an odometer rollback.	<input checked="" type="checkbox"/> No Issues Indicated	<input checked="" type="checkbox"/> No Issues Indicated	<input checked="" type="checkbox"/> No Issues Indicated
Accident / Damage No accidents or damage reported to CARFAX.	<input checked="" type="checkbox"/> No Issues Reported	<input checked="" type="checkbox"/> No Issues Reported	<input checked="" type="checkbox"/> No Issues Reported
Manufacturer Recall Check with an authorized Porsche dealer for any open recalls.	<input checked="" type="checkbox"/> No Recalls Reported	<input checked="" type="checkbox"/> No Recalls Reported	<input checked="" type="checkbox"/> No Recalls Reported
Basic Warranty <u>Original warranty</u> estimated to have expired.	Warranty Expired	Warranty Expired	Warranty Expired

CARFAX Detailed History

Owner 1

Purchased:
2009



Low mileage! This owner drove less than the industry average of 15,000 miles per year.

Corporate Vehicle
4,270 mi/yr

Date	Mileage	Source	Comments
12/04/2009	5	Porsche Monterey Seaside, CA 831-899-8888 seaside.porschedealer.com ★ 4.6 / 5.0 29 Verified Reviews ♥ 52 Customer Favorites	Vehicle serviced - Pre-delivery inspection completed - Vehicle washed/detailed
12/06/2009	10	California Motor Vehicle Dept. Monterey, CA	Odometer reading reported - Titled or registered as corporate vehicle
12/24/2009		California Motor Vehicle Dept. Monterey, CA	Title issued or updated - First owner reported
06/09/2010	2,818	Porsche Monterey Seaside, CA 831-899-8888 seaside.porschedealer.com ★ 4.6 / 5.0 29 Verified Reviews ♥ 52 Customer Favorites	Vehicle serviced - Maintenance inspection completed - Electrical system checked
12/20/2010	5,234	Porsche Monterey Seaside, CA 831-899-8888 seaside.porschedealer.com ★ 4.6 / 5.0 29 Verified Reviews ♥ 52 Customer Favorites	Vehicle serviced - Maintenance inspection completed - Oil and filter changed - Tire condition and pressure checked
12/16/2011	9,965	Porsche Monterey Seaside, CA 831-899-8888 seaside.porschedealer.com ★ 4.6 / 5.0 29 Verified Reviews ♥ 52 Customer Favorites	Vehicle serviced - Maintenance inspection completed - Oil and filter changed - Brake fluid flushed/changed - Transmission checked - Tire condition and pressure checked
12/05/2012	13,295	Porsche Monterey Seaside, CA 831-899-8888 seaside.porschedealer.com ★ 4.6 / 5.0 29 Verified Reviews ♥ 52 Customer Favorites	Vehicle serviced - Maintenance inspection completed - Electrical system checked - Tire condition and pressure checked - Oil and filter changed
07/23/2013	15,514	Porsche Monterey Seaside, CA 831-899-8888 seaside.porschedealer.com ★ 4.6 / 5.0 29 Verified Reviews ♥ 52 Customer Favorites	Vehicle serviced - Floor mats installed - Vehicle washed/detailed - Engine serviced
07/23/2013		Porsche Monterey Seaside, CA 831-899-8888 seaside.porschedealer.com ★ 4.6 / 5.0 29 Verified Reviews ♥ 52 Customer Favorites	Vehicle offered for sale
08/19/2013	15,515	Porsche Monterey Seaside, CA 831-899-8888 seaside.porschedealer.com ★ 4.6 / 5.0 29 Verified Reviews ♥ 52 Customer Favorites	Vehicle serviced

Owner 2

Purchased:
2013



Low mileage! This owner drove less than the industry average of 15,000 miles per year.

Personal Vehicle
3,383 mi/yr

Date	Mileage	Source	Comments
09/10/2013	15,565	California Motor Vehicle Dept. Sonoma, CA	Title issued or updated - New owner reported - Loan or lien reported
09/24/2013		Porsche Monterey Seaside, CA 831-899-8888 seaside.porschedealer.com ★ 4.6 / 5.0 29 Verified Reviews ✓ ♥ 52 Customer Favorites	Vehicle serviced - Vehicle washed/detailed
01/24/2014	18,696	Sonnen Porsche San Rafael, CA 415-380-8000 sonnenporsche.com ★ 4.8 / 5.0 27 Verified Reviews ✓	Vehicle serviced - Maintenance inspection completed - Brake fluid flushed/changed - Oil and filter changed - Convertible top operation checked
02/23/2015	22,753	Sonnen Porsche San Rafael, CA 415-380-8000 sonnenporsche.com ★ 4.8 / 5.0 27 Verified Reviews ✓	Vehicle serviced - Maintenance inspection completed - Oil and filter changed - PCM reprogrammed - Radio/sound system checked
07/21/2015		California Motor Vehicle Dept. Sonoma, CA	Title issued or updated - Loan or lien released
07/22/2015	24,056	Porsche Monterey Seaside, CA 831-899-8888 seaside.porschedealer.com ★ 4.6 / 5.0 29 Verified Reviews ✓ ♥ 52 Customer Favorites	Vehicle serviced - Maintenance inspection completed - Four tires balanced - Four tires mounted - Tire condition and pressure checked
10/08/2015	24,864	Sonnen Porsche San Rafael, CA 415-380-8000 sonnenporsche.com ★ 4.8 / 5.0 27 Verified Reviews ✓	Vehicle serviced - Battery/charging system checked
11/13/2015	25,110	Sonnen Porsche San Rafael, CA 415-380-8000 sonnenporsche.com ★ 4.8 / 5.0 27 Verified Reviews ✓	Vehicle serviced - Maintenance inspection completed - Transmission checked - Radio/sound system checked - Instrument cluster checked
11/30/2015		Sonnen Porsche San Rafael, CA 415-380-8000 sonnenporsche.com ★ 4.8 / 5.0 27 Verified Reviews ✓	Vehicle serviced - Maintenance inspection completed - Instrument cluster checked - Transmission checked - Radio/sound system checked
03/08/2016	26,121	Sonnen Porsche San Rafael, CA 415-380-8000 sonnenporsche.com ★ 4.8 / 5.0 27 Verified Reviews ✓	Vehicle serviced - Maintenance inspection completed - Brake fluid flushed/changed - Oil and filter changed
08/04/2016	26,644	Sonnen Porsche San Rafael, CA 415-380-8000 sonnenporsche.com ★ 4.8 / 5.0 27 Verified Reviews ✓	Vehicle serviced - Brakes checked - Drivability/performance checked
08/05/2016		Porsche Marin Mill Valley, CA 415-380-8000 porschemarin.com ★ 4.8 / 5.0 10 Verified Reviews ✓ ♥ 14 Customer Favorites	Vehicle serviced - Brakes checked - Drivability/performance checked
11/30/2016	27,039	California Inspection Station	Passed emissions inspection

03/09/2017	27,392	Sonnen Porsche San Rafael, CA 415-380-8000 sonnenporsche.com ★ 4.8 / 5.0 27 Verified Reviews	Vehicle serviced - Maintenance inspection completed - Oil and filter changed - Tire condition and pressure checked
------------	--------	--	---

Owner 3

Purchased: 2018



Low mileage! This owner drove less than the industry average of 15,000 miles per year.

Personal Vehicle
1,340 mi/yr

Date	Mileage	Source	Comments
06/08/2018	29,299	California Motor Vehicle Dept. Santa Rosa, CA	Odometer reading reported
06/28/2018		Porsche Marin Mill Valley, CA 415-380-8000 porschemarin.com ★ 4.8 / 5.0 10 Verified Reviews ♥ 14 Customer Favorites	Vehicle serviced - Tire condition and pressure checked - Emissions inspection performed
06/28/2018	29,768	California Inspection Station	Passed emissions inspection
06/28/2018		California Motor Vehicle Dept. Santa Rosa, CA	Title issued or updated - New owner reported
07/25/2018	30,120	Porsche Marin Mill Valley, CA 415-380-8000 porschemarin.com ★ 4.8 / 5.0 10 Verified Reviews ♥ 14 Customer Favorites	Vehicle serviced - Maintenance inspection completed - Tire condition and pressure checked - Tire pressure monitoring system checked
11/22/2019	32,329	Porsche Marin Mill Valley, CA 415-380-8000 porschemarin.com ★ 4.8 / 5.0 10 Verified Reviews ♥ 14 Customer Favorites	Vehicle serviced - Maintenance inspection completed - Tire condition and pressure checked - Oil and filter changed
02/26/2020	32,459	California Inspection Station	Passed emissions inspection
07/23/2021	33,489	Porsche Marin Mill Valley, CA 415-380-8000 porschemarin.com ★ 4.8 / 5.0 10 Verified Reviews ♥ 14 Customer Favorites	Vehicle serviced - Maintenance inspection completed - 10,000 mile service performed - Tire condition and pressure checked - Oil and filter changed

Have Questions? Please visit our Help Center at www.carfax.com.

CARFAX Glossary

First Owner

When the first owner(s) obtains a title from a Department of Motor Vehicles as proof of ownership.

New Owner Reported

When a vehicle is sold to a new owner, the Title must be transferred to the new owner(s) at a Department of Motor Vehicles.

Ownership History

CARFAX defines an owner as an individual or business that possesses and uses a vehicle. Not all title transactions represent changes in ownership. To provide estimated number of owners, CARFAX proprietary technology analyzes all the events in a vehicle history. Estimated ownership is available for vehicles manufactured after 1991 and titled solely in the US including Puerto Rico. Dealers sometimes opt to take ownership of a vehicle and are required to in the following states: Maine, Massachusetts, New Jersey, Ohio, Oklahoma, Pennsylvania and South Dakota. Please consider this as you review a vehicle's estimated ownership history.

Title Issued

A state issues a title to provide a vehicle owner with proof of ownership. Each title has a unique number. Each title or registration record on a CARFAX report does not necessarily indicate a change in ownership. In Canada, a registration and bill of sale are used as proof of ownership.

Follow Us:  facebook.com/CARFAX  [@CARFAXinc](https://twitter.com/CARFAXinc)  About CARFAX

CARFAX DEPENDS ON ITS SOURCES FOR THE ACCURACY AND RELIABILITY OF ITS INFORMATION. THEREFORE, NO RESPONSIBILITY IS ASSUMED BY CARFAX OR ITS AGENTS FOR ERRORS OR OMISSIONS IN THIS REPORT. CARFAX FURTHER EXPRESSLY DISCLAIMS ALL WARRANTIES, EXPRESS OR IMPLIED, INCLUDING ANY IMPLIED WARRANTIES OF MERCHANTABILITY OR FITNESS FOR A PARTICULAR PURPOSE.

© 2021 CARFAX, Inc., a unit of IHS Markit Ltd. All rights reserved.
9/22/21 6:52:04 PM (CDT)

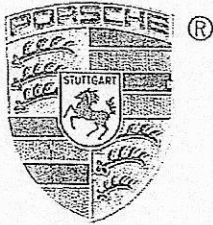

2010 Boxster S

Exterior: GT Silver Metallic
Interior: Natural Leather Cocoa

PORSCHE

STANDARD EQUIPMENT

Mechanical

Boxed 6 cylinder, 3.4 liter
180 ft torque
Aluminum alloy block & cylinder heads
Dry sump lubrication
Overhead cams w/ 4 valves per cyl
Variable valve timing and lift
Direct injection induction system
Dual exhaust manifolds
Electronic anti-knock control
Dual mass flywheel
Automatic Suspension System
Front & Rear
Stability Management
Drag Torque Control
Electronic Brake Differential
Disc brakes w/ 4 piston calipers - F
Disc brakes w/ 4 piston calipers - R
ABS indicators on each pad
18 inch wheels w/ 235/40ZR18 tires - F
18 inch wheels w/ 265/40ZR18 tires - R
Tire Pressure Monitoring
Safety/Environment
Emission Vehicle) status

Safety/Environment

High strength steel & Boron steel safety
Aluminum luggage lids
Side Impact Protection
Front airbags, Thorax airbags
Side airbags in doors, (6 total)
Tensioners & force limiters
Made of Stainless Steel
Trim made of Stainless Steel
Convenience
Adjustable, height and reach adjustable

Convenience

Convertible top w/ 3 layers
Activated active carbon filter
Fixed rear spoiler
Keyless entry w/ coming home feature
Theft alarm w/ int surveillance
Cruise Control
FM/CD radio w/ 7 loudspeakers
Sound Package Plus
Trip computer
Keyless

OPTIONS

Manufacturer's Suggested Retail Price:

Boxster S	58000
GT Silver Metallic	3140
Cocoa Top	0
Natural Leather Cocoa	2815
Self-Dim Mirrors & Rain Sensor	690
Power Seat Package	1550
PCM 3.0 w/ Extended Navigation	3110
7-speed Porsche Doppelkupplung	3420
Heated Front Seats	510
Heated Steering Wheel	210
Wheel Caps with Colored Crest	185
Porsche Windstop (Deflector)	375
Automatic Climate Control	550
Bluetooth Interface for Mobile	695
Bose High End Sound Package	990
Floor Mats in Interior Color	90
Universal Audio Interface	440

PRICE

EXCLUSIVE OPTIONS

Manufacturer's Suggested Retail Price:

Storage Bin Lid w/ Porsche Crest	330
Roll Bar Painted Exterior Color	535

PRICE

*Gasoline, license and title fees, state and local taxes and dealer installed options and accessories are not included.

EXCLUSIVE OPTIONS	865
DESTINATION CHARGE	950

TOTAL PRICE * \$ 78,585

Order Reference: 2329942

Location: SD296

Method of Trans: Truck

Sold to
Dealer
152

Porsche of Monterey
1781 Del Monte Blvd
Seaside CA 93955

Ship to
Dealer
152

Porsche of Monterey
1781 Del Monte Blvd
Seaside CA 93955

WP0CB2A89AU730183





PORSCHE

Certificate of Authenticity

The Porsche vehicle with the identification number listed below was manufactured with the following assembly specifications:

WPOCB2A89AU730183

Model Year/Type

2010 Boxster S

Production Completion Date

10/14/2009

**Manufacturer's Suggested
Retail Price (MSRP)**

\$77,635.00 USD

Engine Number/Type

A02685 (MA121)

Transmission Number/Type

1006373 (CG220)

Exterior Paint Color/Code

GT Silver Metallic/U2

Interior Material Color/Type

Cocoa Natural Leather/RA

Optional Equipment

Porsche Doppelkupplung
Heated Seats - Front
Heated Steering Wheel
Wheel Caps w/ Colored Crest
Porsche Windstop (Deflector)
Automatic Climate Control
Mobile Bluetooth Interface
Bose High End Sound Package
Floor Mats Interior Color

Universal Audio Interface
Storage Lid w/ Porsche Crest
Self Dimming Mirrors & Rain
Sensor
Power Seat Package
PCM w/ Extended Navigation
Roll Bars Exterior Color
Michelin Tires

Detlev von Platen
President and Chief Executive Officer
Porsche Cars North America, Inc.

Multi-Point Inspection Form

RO# 362936

STEVE IMBODEN

VIN WP0CB2A89AU730183

Advisor Gary Wright

Technician Zaldy Gadiana

Created On 7/23/2021

Checked and OK at this time

May Require Future Attention

Requires immediate attention

Interior / Exterior	
<input checked="" type="checkbox"/>	Bulbs and Lights
<input checked="" type="checkbox"/>	Windshield Washer Spray / Wiper Operation / Wiper Blades / Including Rear (if applicable)
<input checked="" type="checkbox"/>	Windshield / Window Condition
<input checked="" type="checkbox"/>	Upholstery / Carpet / Floor Mats / Mirrors / Trim
<input checked="" type="checkbox"/>	Emergency Brake Adjustment
<input checked="" type="checkbox"/>	Horn Operation
<input checked="" type="checkbox"/>	Fuel Tank Cap Gasket
<input type="checkbox"/>	Clutch Operation (if equipped)
<input type="checkbox"/>	Cabin/HEPA Filter (if equipped)
Battery Performance	
<input type="checkbox"/>	Battery Terminals / Cables / Mountings
<input type="checkbox"/>	Check Condition of Battery (Storage Capacity Test if Applicable)
Under Hood	
<input type="checkbox"/>	Fluids: Oil / Coolant / Power Steering / Brake Fluid / Washer
<input type="checkbox"/>	Engine Air Filter
<input type="checkbox"/>	Belts / Tensioners (condition and adjustment)
<input type="checkbox"/>	Cooling System Hoses / Heater Hoses / Air Conditioning Hoses and Connections
<input type="checkbox"/>	Radiator Core / Air Conditioning Condenser (if equipped)

Under Vehicle	
<input checked="" type="checkbox"/>	Shock Absorbers / Suspension
<input checked="" type="checkbox"/>	Steering Gear Box / Linkage and Boots / Ball Joints / Dust Covers
<input checked="" type="checkbox"/>	Muffler / Exhaust Pipes / Mountings
<input checked="" type="checkbox"/>	Engine Oil and/or Fluid Leaks
<input checked="" type="checkbox"/>	Drive Shaft Boots / Constant Velocity Boots / U-joints / Transmission Linkage (if equipped)
<input checked="" type="checkbox"/>	Transmission / Differential / Transfer Case (Check Fluid Level, Fluid Condition and Fluid Leaks)
<input checked="" type="checkbox"/>	Fuel Lines and Connections / Fuel Tank Band / Fuel Tank Vapor Vent System Hoses
<input checked="" type="checkbox"/>	Inspect Nuts and Bolts on Body Chassis
Tread Depth (measured in 1/32")	
	
<input checked="" type="checkbox"/>	LF <u>8</u>
<input checked="" type="checkbox"/>	RF <u>8</u>
<input checked="" type="checkbox"/>	LR <u>8</u>
<input checked="" type="checkbox"/>	RR <u>8</u>
<input type="checkbox"/>	Spare Tire (if applicable)
<input checked="" type="checkbox"/>	LF/RF Tire Pressure <u>33</u>
<input checked="" type="checkbox"/>	LR/RR Tire Pressure <u>33</u>
Abnormal Wear Pattern of Tires	
<input checked="" type="checkbox"/>	LF
<input checked="" type="checkbox"/>	RF
<input checked="" type="checkbox"/>	LR
<input checked="" type="checkbox"/>	RR
Check Brake Linings (measured in millimeters)	
<input checked="" type="checkbox"/>	LF <u>Z</u>
<input checked="" type="checkbox"/>	RF <u>Z</u>
<input type="checkbox"/>	LR <u>5</u>
<input type="checkbox"/>	RR <u>5</u>

Porsche Boxster S, 2010:

Vanity License ideas: 4EVRFUN, WICK. PUTPUT

Ray Ramsey, Porsche of Monterey

VIN: WPoCB2A89AU730183

Purchased 8/17/2013

License# 6GDY606

Mileage 15,516

Warrantied until December 6, 2015 or 100K miles.

First purchaser history:

Originally purchased 12/04/2009.

First oil change - 5,234 on 12/20/2010

2nd oil change & brake system flush - 9,905 on 12/16/11. 3rd oil change - 13,295 on 12/05/12.

RGW purchased 08/17/2013

08/19/13 - 15,516, updated PCM Nav

09/05/13 - 16,215

09/15/13 - 16,695

10/04/13 - 16,802

10/25/13 - 17,165

11/20/13 - 17,629

12/13/13 - 17,772

01/17/14 - 18,520

01/24/14 - 18,697, 20K Service, oil/filter change, brake system flush & fluid replacement, pads at 90% front & 85% rear, tires 4.5 mm front, 4mm rear. \$425.69 @ Sonnen Porsche in San Rafael.

02/15/14 - 19,003

02/23/14 - 19,120

03/15/14 - 19,223

04/05/14 - 19,778

05/01/14 - 19,857

06/08/14 - 20,290

06/25/14 - 21,001

08/07/14 - 21,256

08/27/14 - 21,623

09/12/14 - 21,717

10/15/14 - 22,045

11/14/14 - 22,108 Registration for December 2015, \$381.

12/20/14 - 22,250

01/03/15 - 22,403

02/23/15 - 22,753 Oil/filter change, courtesy inspection, PCM check - programming problems. Updated PCM software. \$208.47.

03/05/15 - 22,883

04/11/15 - 23,183

04/28/15 - 23,272

05/28/15 - 23,369

06/12/15 - 23,401

07/01/15 - 23,633

07/22/15 - 24,056 New Tires, installed at Porsche of Monterey. Michelin Super Sport. \$1,259.09 installed. 45 Months remaining on tire pressure sensors. 29 MPG on trip to/fro Monterey.

07/23/15 - 24,244

10/01/15 - 24,864

10/08/15 - 24,864 New Battery, installed at Sonnen Porsche in Mill Valley. \$317.99.

10/30/15 - 24,955

11/30/15 - 25,108 Checkup before expiration of CPO warranty. Starts without pressing on brake. Replaced "Rear-End Control Unit" - Fixed. Radio volume does not change with vehicle speed - Replaced PCM - fixed (dealer said that it is barely noticeable). Very slight ding on rear bumper pad, which was caused during prior service at Sonnen Porsche of Mill Valley - Fixed. All no charge by dealer.

12/09/15 - 25,265

01/07/16 - 25,497

02/27/16 - 26,055
03/08/16 - 26,121 Oil/filter change, brake system flush & fluid replacement, courtesy inspection. \$521.88. Sonnen Porsche, Mill Valley.
04/02/16 - 26,205
04/05/16 - 26,255
05/07/16 - 26,279
06/03/16 - 26,375
06/24/16 - 26,382
06/30/16 - 26,425
07/05/16 - 26,706
09/20/16 - 26,830
10/02/16 - 26,883
10/29/16 - 26,913
11/20/16 - 27,028
12/02/16 - 27,100
12/31/16 - 27,226
01/16/17 - 27,314
03/09/17 - 27,392 Oil change, multi point inspection \$262.54. Sonnen Porsche, Mill Valley.
03/26/17 - 27,575
05/02/17 - 27,709
06/25/17 - 27,766
07/01/17 - 27,771
07/20/17 - 28,212
08/20/17 - 28,605
12/11/17 - 28,827
02/16/18 - 29,113
03/28/18 - 29,129
06/08/18 - 29,299 Steve Imboden takes ownership
06/15/18 - 29,454 Oil Change (Castrol), Brake fluid flush, Fuel additive, general inspection: \$399.93 de Yung Motorsport, Cotati, CA
06/28/18 - 29,768 California Smog Inspection: \$85.00 Porsche Marin, Mill Valley
07/25/18 - 30,117 Replaced TPM module and all four tire sensors (and batteries): \$1943.58 Porsche Marin
07/28/19 - 31,830
11/22/19 - 32,328 Oil Change (Mobil1) and Brake fluid flush, 10k service, multi-point inspection: \$563.76 Porsche Marin
06/15/20 - 32,729
05/09/21 - 33,385
07/23/21 - 33,488 Oil Change (Mobil1) multi-point inspection: \$383.83 Porsche Marin

Gary Wright – Porsche Marin (formerly Sonnen Porsche)
Email: gary.wright@sonnenporsche.com/16
Direct Number: 415-381-7822
Service # (415) 380-8000

Bruce Canepa, cvc.
Assistant: Phyllis
4900 SCOTTS VALLEY DRIVE
SCOTTS VALLEY, CA. 95066
831-430-9940

CUSTOMER #: I210496

362936



PORSCHE MARIN

900 Redwood Highway
Mill Valley, California 94941
Telephone: (415) 380-8000

INVOICE

SANTA ROSA, CA 95409

PAGE 1

HOME: 707

CONT:

BUS: 707

CELL:

SERVICE ADVISOR: 5045 GARY J WRIGHT

Table with columns: COLOR, YEAR, MAKE/MODEL, VIN, LICENSE, MILEAGE IN / OUT, TAG. Row 1: SILVER, 10, PORSCHE BOXSTER, WP0CB2A89AU730183, 6GDY606, 33488/33489, T583.

Table with columns: DEL. DATE, PROD. DATE, WARR. EXP., PROMISED, PO NO., RATE, PAYMENT, INV. DATE. Row 1: 06DEC09, 16OCT09, 06DEC2013, WAIT 23JUL21, 0.00, CASH, 23JUL21.

Table with columns: LINE OPCODE, TECH TYPE, HOURS, LIST, NET, TOTAL. Includes entries for engine oil and filter change, and 10,000 mile main service.

B MULTI POINT INSPECTION
CAUSE: COMPLETED MULTI POINT INSPECTION
MPI MULTI POINT INSPECTION
5016 IPS 0.00 (N/C)
33489 PERFORMED MULTI POINT INSPECTION. REAR BRAKES CLOSED TO SENSORS. RECOMMEND TO BE REPLACED. ALL TIRES HAS AN 8/32 TREAD DEPTH. CHECKED ALL LIGHTS, FLUID, AND COOLANT LEVEL.

C CHECK AND INFLATE EACH VEHICLES TIRE TO THE RECOMMENDED INFLATION PRESSURE AND RECORD PRESSURE CHECK AND RECORD TIRE TREAD DEPTH AND CONDITON FOR EACH TIRE
CAUSE: CHECKED AND ADJUSTED ALL TIRES AS NEEDED
04POZ1 CHECK AND INFLATE EACH VEHICLES TIRE TO THE RECOMMENDED INFLATION PRESSURE AND RECORD PRESSURE CHECK AND RECORD TIRE TREAD DEPTH AND CONDITON FOR EACH TIRE
5016 IPS 0.00 (N/C)
33489 ADJUSTED ALL TIRE PRESSURE TO FACTORY SPECIFICATION.

D PORSCHE MOBILITY PROGRAM, LYFT RIDE
MOBILITY PORSCHE MOBILITY PROGRAM, PORSCHE LOANER CAR OR SHUTTLE RIDE.
5016 ISL 0.00 (N/C)

Form with multiple sections: Original Estimate, Revised Estimate, Authorization Obtained By, HAZARDOUS WASTE DISPOSAL COSTS, LABOR AMOUNT, PARTS AMOUNT, GAS, OIL, LUBE, SUBLET AMOUNT, WASTE DISPOSAL COSTS, TOTAL CHARGES, LESS INSURANCE, SALES TAX, PLEASE PAY THIS AMOUNT.

CUSTOMER #: I210496

362936



PORSCHE MARIN

INVOICE

PORSCHE

900 Redwood Highway
Mill Valley, California 94941
Telephone: (415) 380-8000

SANTA ROSA, CA 95409

PAGE 2

HOME:
BUS: 70

SERVICE ADVISOR: 5045 GARY J WRIGHT

Table with columns: COLOR, YEAR, MAKE/MODEL, VIN, LICENSE, MILEAGE IN / OUT, TAG. Row 1: SILVER, 10, PORSCHE BOXSTER, WP0CB2A89AU730183, 6GDY606, 33488/33489, T583.

Table with columns: DEL. DATE, PROD. DATE, WARR. EXP., PROMISED, PO NO., RATE, PAYMENT, INV. DATE. Row 1: 06DEC09, DD16OCT09, 06DEC2013, WAIT 23JUL21, 0.00, CASH, 23JUL21.

E You consent to receiving texts from us on your cell phone at the number you have provided. You agree that we may contact you regarding customer service updates or offers via auto-dialer text. If you do not agree, you may provide a landline number. Yo

01POTEXT You consent to receiving texts from us on your cell phone at the number you have provided. You agree that we may contact you regarding customer service updates or offers via auto-dialer text. If you do not agree, you may provide a landline number. Yo

999 IPS 0.00 (N/C)

EST: 445.00 23JUL21 09:18 SA: 5045

CONTACT:

Form with sections: Original Estimate, Revised Estimate, *HAZARDOUS WASTE DISPOSAL COSTS, ALL PARTS ARE NEW UNLESS OTHERWISE INDICATED, and a table with columns: DESCRIPTION, TOTALS.

NOTICE TO CONSUMER: PLEASE READ IMPORTANT INFORMATION ON BACK.

Porsche Marin

IndiGO San Francisco LLC

07/23/2021 10:55 AM PDT

900 REDWOOD HWY FRONTAGE RD

MILL VALLEY, CA, 94941

415-524-7236 (Office)

indigoautogroup.com

MARINVENDORS@INDIGOAUTOGROUP.COM

BILLED TO



DETAILS

DETAILS	Approved (00)
TYPE	Charge - Capture
APPROVAL	03076M
TRANS ID	81005
MID	*****9325
TID	70700668
TERMINAL	200207
APP	Mastercard
AID	A0 00 00 00 04 10 10
TVR	8000008000
IAD	5FBA5E658CD797840012
TSI	6800
ARC	00
INVOICE	362936

signature

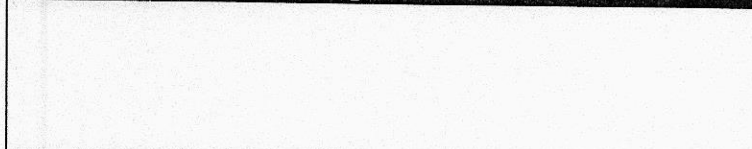

Cardmember acknowledges receipt of goods and/or services in the amount of the total shown hereon and agrees to perform the obligations set forth by the cardmember's agreement with the issuer.

ACCOUNT	Mastercard ... 0526
ENTRY MODE	Chip
CVM	SIGN
AMOUNT	USD\$383.83
TOTAL	\$383.83

Smog Check Vehicle Inspection Report (VIR)

Vehicle Information

Test Date/Time: 02/26/2020 @ 10:02 AM

Model Year: 2010	Vehicle Make: PORSCHE	Vehicle Model: BOXSTER S
VIN (scanned from vehicle): WP0CB2A89AU730183		
VIN (manually entered or from DMV document): WP0CB2A89AU730183		
License Plate: IBOXSTA	License State: CA	Fuel Type: Gasoline
Certification Type: California	Odometer: 32459	

Overall Test Result

PASS

Congratulations! Your vehicle passed the Smog Check inspection, which helps California reach its daily goal of removing smog-forming emissions from the air. Thank you for keeping your vehicle well maintained.

Visual Inspection: PASS Functional Inspection: PASS

Smog Check Certificate Number: RE577041C

DMV ID Number: 8984E312R593

Your Smog Check certificate has been electronically transmitted to DMV.

Your certificate is valid for 90 days from date of issuance.

Please keep this copy for your records.

Visual Inspection Result Information

<u>Result</u>	<u>Inspection Category</u>	<u>Result</u>	<u>Inspection Category</u>
NOTAPPLICABLE	Air Injection System	PASS	Catalyst
PASS	Computers, Sensors, Switches, and Wiring	PASS	Crankcase Emission Control
PASS	Exhaust Gas Recirculation (EGR)	PASS	Fuel Evaporative System (EVAP)
PASS	Fuel Metering System	PASS	Other Emission Related Components/Systems
NOTAPPLICABLE	Turbocharger/Supercharger	PASS	Vacuum Lines to Sensors/Switches

Emission Control Systems Functional Check Results

<u>Result</u>		<u>Result</u>	
PASS	Liquid Fuel Leak Check	PASS	OBDII
PASS	Smoke Check		

Smog Check Inspection Station Information

Station ID: RC225698	Inspector Name/ID: VAZQUEZ, EZEQUIEL/P0636056
BONNEAUS TOWING & MECHANICAL LLC	Software Version/OIS ID: 8.12.1047.0/CV010389
23003 ARNOLD DRIVE	
SONOMA, CA 95476	
(707) 938-8133	

I certify, under penalty of perjury, under the laws of the State of California, that I performed the inspection in accordance with all bureau requirements, and that the information listed on this vehicle inspection report is true and accurate.

2/26/20

Date

Inspector's Signature

DEALER BONNEAU'S TOWING & MECHANICAL 23003 ARNOLD DR SONOMA CA 95476 (707) 938-8133 BAR #AA225698		CUSTOMERS NAME & ADDRESS [REDACTED] [REDACTED] SANTA ROSA CA 95409 - [REDACTED]		DATE & TIME 02/26/20 09 :51
E.P.A. NUM		VEHICLE LICENSE NO. 1BOXSTA		WRITTEN BY:
ODOMETER 32,459		VEHICLE DESCRIPTION 10POR 911..	VEHICLE IDENTIFICATION NO.	
PROMISED: 02/ 26		PAYMENT METHOD		<input type="checkbox"/> DELIVER
<input type="checkbox"/> MC/VISA <input type="checkbox"/> OTHER		CREDIT CARD NO.	CREDIT AUTHORIZATION	
<input type="checkbox"/> WILL CALL		SERVICE REPAIR INSTRUCTIONS/SYMPTOMS		
<input type="checkbox"/> CALL WHEN READY				
SERVICED BY DVH		INSPECTED BY DVH		

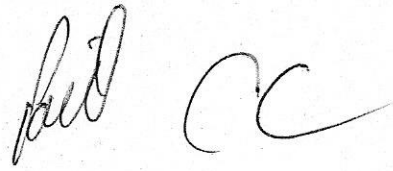
TECH	QTY	PART NO.	REPAIR/SERVICE DESCRIPTION	PARTS	LABOR
VASQI	00		SMOG INSPECTION By law, you may choose another facility to perform any needed repairs or adjustments which the Smog Check test indicates are necessary.		64.95
VASQI	00		SMOG CERTIFICATE ***** * THANK YOU! * * We appreciate your Business! * ***** 	8.25	

CUSTOMER REQUESTED RETURNED PARTS <input type="checkbox"/> YES <input checked="" type="checkbox"/> NO		SAFETY RECOMMENDATIONS				TOTALS					
I, the registered owner, authorize you to perform the above repairs and furnish necessary materials. I understand any cost quoted heretofore is an estimate only. Your employees may operate vehicle for inspection, testing, delivery at my risk. You will not be responsible for loss or damages to vehicle or articles left in it. I agree to pay reasonable storage on vehicle left more than 48 hours after notification that repairs are completed. An express Mechanic's Lien is acknowledged on above vehicle to secure the amount of repairs thereto, including those from any prior work or repair contract on this vehicle. In the event an attorney is retained to foreclose on this lien or to bring suit for collection of any sums due, I agree to pay cost of collection and any reasonable attorney fees. Receipt of a copy of this order is hereby acknowledged.		TIRES, BRAKES, BATTERY & COOLANT				LABOR	64.95				
						TIRES	RF	LF	RR	LR	SPARE
		CUSTOMER SIGNATURE X		TREAD						SALES TAX	
				PSI						GASOLINE	GALS
		BRAKES-F	%		BRAKES-R	%		SMOG CER	8.25		
		BATTERY						SUB-LET			
		COOLANT						DEPOSIT	()		
						TOTAL	73.20				
REVISED ESTIMATE	PARTS BY	LABOR AUTHORIZED BY CUSTOMER	TOTAL	DATE	TIME	<input type="checkbox"/> IN PERSON <input type="checkbox"/> BY PHONE	I ACKNOWLEDGE NOTICE AND ORAL APPROVAL OF AN INCREASE IN THE ORIGINAL ESTIMATED PRICE.				
							X				

CUSTOMER #: I210496

350378

INVOICE



PORSCHE MARIN

900 Redwood Highway
Mill Valley, California 94941
Telephone: (415) 380-8000

SANTA ROSA, CA 95409 345

PAGE 1

HOM# 166 CO# 166
BUS: 164 CELL: 7

SERVICE ADVISOR: 5045 GARY J WRIGHT

Table with columns: COLOR, YEAR, MAKE/MODEL, VIN, LICENSE, MILEAGE IN / OUT, TAG. Includes details for a silver 2010 Porsche Boxster.

Main service list table with columns: LINE, OPCODE, TECH, TYPE, HOURS, LIST, NET, TOTAL. Lists various services like engine oil change, multi-point inspection, and brake flush.

Form containing customer and dealer signatures, dates, and a table for hazardous waste disposal costs.

NOTICE TO CONSUMER: PLEASE READ IMPORTANT INFORMATION ON BACK.

Multi-Point Inspection Checklist Per Manufacturer's Recommendation

Customer Name: [Redacted] Year/Model: 2010 Boxster Date: 11/22/19
 RO/Tag: 350376 Mileage: 32379

OKAY AT THIS TIME

MAY REQUIRE FUTURE ATTENTION

REQUIRES PROMPT ATTENTION

CHECK FLUID LEVELS AND FILL

OK <input type="radio"/> FILL <input checked="" type="radio"/> Engine Oil	OK <input checked="" type="radio"/> FILL <input type="radio"/> Brake Reservoir	OK <input checked="" type="radio"/> FILL <input type="radio"/> Power Steering
<input checked="" type="radio"/> <input type="radio"/> Transmission	<input type="radio"/> <input checked="" type="radio"/> Window Washer	<input checked="" type="radio"/> <input type="radio"/> Coolant Recover Reservoir

RECOMMENDED SCHEDULED MAINTENANCE SERVICES

<input type="radio"/> Oil Change	<input type="radio"/> Fuel Filter
<input type="radio"/> Oil Filter	<input type="radio"/> Cabin Air Filter
<input type="radio"/> Engine Air Filter	<input type="radio"/> Spark Plugs
<input type="radio"/> Engine Coolant	<input type="radio"/> Tire Rotation
<input type="radio"/> Transmission Fluid	<input type="radio"/> Seat Filter
<input type="radio"/> Transmission Filter	<input type="radio"/> Accessory Drive Belt(s)

Comments: _____

CHECK BATTERY

State of Health

0% 100%

Condition of Terminals

Good Bad
 (Clean if necessary)
 Declined Battery

CHECK FOLLOWING SYSTEMS/COMPONENTS

<input checked="" type="radio"/> <input type="radio"/> <input type="radio"/>	<input type="radio"/> Operation of horn, interior lights, exterior lamps, turn signals, hazard and brake lamps	Declined <input type="checkbox"/>
<input checked="" type="radio"/> <input type="radio"/> <input type="radio"/>	<input type="radio"/> Radiator, heater, and air-conditioning hoses for leaks and damage	<input type="checkbox"/>
<input checked="" type="radio"/> <input type="radio"/> <input type="radio"/>	<input type="radio"/> Windshield for cracks, chips and pitting	<input type="checkbox"/>
<input checked="" type="radio"/> <input type="radio"/> <input type="radio"/>	<input type="radio"/> Windshield washer spray, wiper operation and wiper blades	<input type="checkbox"/>
<input checked="" type="radio"/> <input type="radio"/> <input type="radio"/>	<input type="radio"/> Accessory drive belt(s)	<input type="checkbox"/>
<input checked="" type="radio"/> <input type="radio"/> <input type="radio"/>	<input type="radio"/> Brake system (including lines, hoses, and parking brake) and wheel end for end-play and bearing noise	<input type="checkbox"/>
<input checked="" type="radio"/> <input type="radio"/> <input type="radio"/>	<input type="radio"/> Clutch operation (if equipped)	<input type="checkbox"/>
<input checked="" type="radio"/> <input type="radio"/> <input type="radio"/>	<input type="radio"/> Constant velocity (CV) drive axle boots (if equipped)	<input type="checkbox"/>
<input checked="" type="radio"/> <input type="radio"/> <input type="radio"/>	<input type="radio"/> Drive shaft, transmission, u-joint and shift linkage (if equipped) and lubricate (as needed)	<input type="checkbox"/>
<input checked="" type="radio"/> <input type="radio"/> <input type="radio"/>	<input type="radio"/> Engine Cooling system, hoses and clamps	<input type="checkbox"/>
<input checked="" type="radio"/> <input type="radio"/> <input type="radio"/>	<input type="radio"/> Exhaust system (leaks, damage, loose parts)	<input type="checkbox"/>
<input checked="" type="radio"/> <input type="radio"/> <input type="radio"/>	<input type="radio"/> Oil and/or fluid leaks	<input type="checkbox"/>
<input checked="" type="radio"/> <input type="radio"/> <input type="radio"/>	<input type="radio"/> Shocks/struts and other suspension components for leaks and/or damage	<input type="checkbox"/>
<input checked="" type="radio"/> <input type="radio"/> <input type="radio"/>	<input type="radio"/> Steering and steering linkages	<input type="checkbox"/>
STATE INSPECTION DUE (IF APPLICABLE) _____ MONTH / _____ DAY / _____ YEAR		

Comments: _____

CHECK BRAKES - MEASURE FRONT/REAR BRAKE LININGS

LF <input checked="" type="radio"/>	<u>5mm</u>		<u>5mm</u>	RF <input checked="" type="radio"/>
<input type="radio"/>				<input type="radio"/>
<input type="radio"/>				<input type="radio"/>
<input checked="" type="radio"/>	<u>2mm</u>		<u>2mm</u>	RR <input checked="" type="radio"/>
<input type="radio"/>				<input type="radio"/>
<input type="radio"/>				<input type="radio"/>
LR <input type="radio"/>				RR <input type="radio"/>

Declined Brake

Over 5mm or 7/32" (Disc) or Over 2mm or 3/32" (Drum)
 3 to 5mm or 4/32" to 7/32" (Disc) or 1.01 to 2mm (Drum) or 2/32" to 3/32"
 Less than 3mm or 4/32" (Disc) or 1mm or 2/32" or Less (Drum)

BRAKE MEASUREMENTS NOT TAKEN THIS SERVICE VISIT

Comments: _____

CHECK TIRES

LF <input checked="" type="radio"/>	7/32" or Greater <u>6.5/32</u>		RF <input checked="" type="radio"/>	7/32" or Greater
<input type="radio"/>	4/32" to 6/32"		<input type="radio"/>	4/32" to 6/32"
<input type="radio"/>	3/32" or less		<input type="radio"/>	3/32" or less
<input checked="" type="radio"/>	7/32" or Greater <u>6.5/32</u>		<input checked="" type="radio"/>	7/32" or Greater
<input type="radio"/>	4/32" to 6/32"		<input type="radio"/>	4/32" to 6/32"
<input type="radio"/>	3/32" or less		<input type="radio"/>	3/32" or less
LR <input type="radio"/>			RR <input type="radio"/>	

Declined Tire

WEAR PATTERN/DAMAGE

LF RF
 LR RR

TIRE WEAR INDICATES:
 Alignment Check Needed Wheel Balance Needed

Comments: _____

TIRE PRESSURE SET TO FACTORY RECOMMENDED PSI

Front Rear

Customer Signature: _____

Service Advisor: Gary Wright
 Technician: Katie Miller

PORSCHE MARIN

INVOICE

900 REDWOOD HIGHWAY • MILL VALLEY, CA 94941

Ph: (415) 380-8000

415-380-8000

PORSCHE

BAR # AA 219898

CPAL# CA000083774

CUSTOMER NO. 210496	ADVISOR GARY WRIGHT	942	TAG NO. 463	INVOICE DATE 07/25/18	INVOICE NO. POCS472409
	LICENSE NO. 6GDY606		MILEAGE 30,117	COLOR SILVER/	STOCK NO.
RESIDENCE PHONE SANTA ROSA, CA 95409-4345	YEAR / MAKE / MODEL 10/PORSCHE/BOXSTER S/BOXSTER S			DELIVERY DATE 12/06/09	DELIVERY MILES
	VEHICLE I.D. NO. WP0CB2A89AU730183			SELLING DEALER NO.	PRODUCTION DATE 10/16/09
	F.T.E. NO.		P.O. NO.	R.O. DATE 07/24/18	
COMMENTS					MO: 30120

JOB# 1 CHARGES-----

LABOR-----
J# 1 04POZ2 TPM LIGHT TECH(S):2247 700.00

CLIENT STATES THE TPC INACTIVE WARNING IS ON.
- CHECK AND ADVISE.
TPM CONTROL UNIT INTERNAL FAULT.
BATTERY LIFE LOW ON ALL 4 TPM SENSORS.
REMOVED AND REPLACED CONTROL UNIT CODE AND CLEAR CODES.
REPLACED ALL 4 TIRE PRESSURE SENSORS AND CALIBRATE.
OPERATING OK.

PARTS-----	QTY---	FP-NUMBER-----	DESCRIPTION-----	UNIT PRICE-	PRICE-
	1	997-618-191-02	CONTROL UNIT, IN	362.36	362.36
	4	9P1-601-361-C	TIRE VALVE	30.56	122.24
	4	9A7-907-275-06	SENSOR	166.05	664.20
			TOTAL - PARTS		1148.80

JOB# 1 TOTALS-----
LABOR 700.00
PARTS 1148.80

JOB# 1 JOURNAL PREFIX POCS JOB# 1 TOTAL 1848.80

JOB# 2 CHARGES-----

LABOR-----
J# 2 03POZ000 MULTI-POINT INSPECT TECH(S):2247 INTERNAL

PERFORM INSPECTIONS AS PER MULTI-POINT INSPECTION FORM
NO PROBLEMS FOUND.

JOB# 2 TOTALS-----
JOB# 2 JOURNAL PREFIX POCS JOB# 2 TOTAL 0.00

JOB# 3 CHARGES-----

LABOR-----
J# 3 04POZ1 TIRE INFLATION CHECK TECH(S):2247 INTERNAL

CHECK AND INFLATE EACH VEHICLES TIRE TO THE RECOMMENDED
INFLATION PRESSURE AND RECORD PRESSURE.
CHECKED AND ADJUSTED ALL TIRES AS NEEDED
COMPLETED.

JOB# 3 TOTALS-----
JOB# 3 JOURNAL PREFIX POCS JOB# 3 TOTAL 0.00

JOB# 4 CHARGES-----

LABOR-----
J# 4+99POZZLOANER PORSCHE LOANER TECH(S):98 WARRANTY

CUSTOMER PROVIDED LOANER VEHICLE.
WP1AA2A21JKA05189
LC3828

THANK YOU

PORSCHE MARIN

INVOICE

900 REDWOOD HIGHWAY • MILL VALLEY, CA 94941

Ph: (415) 380-8000

415-380-8000

PORSCHE

BAR # AA 219898

CPA#: CA0000846374

CUSTOMER NO. 210496	ADVISOR GARY WRIGHT	942	TAG NO. 463	INVOICE DATE 07/25/18	INVOICE NO. POCS472409
	LICENSE NO. 6GDY606		MILEAGE 30,117	COLOR SILVER/	STOCK NO.
SANTA ROSA, CA 95409-4345	YEAR / MAKE / MODEL 10/PORSCHE/BOXSTER S/BOXSTER S			DELIVERY DATE 12/06/09	DELIVERY MILES
	VEHICLE I.D. NO. W P 0 C B 2 A 8 9 A U 7 3 0 1 8 3			SELLING DEALER NO.	PRODUCTION DATE 10/16/09
	F.T.E. NO.		P.O. NO.	R.O. DATE 07/24/18	
RESIDENCE PHONE	BUSINESS PHONE	COMMENTS			

MO: 30120

JOB# 4 TOTALS-----

JOB# 4 JOURNAL PREFIX POCS JOB# 4 TOTAL 0.00

ESTIMATE-----

CUSTOMER HEREBY ACKNOWLEDGES RECEIVING ORIGINAL ESTIMATE OF \$2050.00 (+TAX)

TOTALS-----

*
* [] CASH [] CHECK CK NO. [] *
* [] VISA [] MASTERCARD *
* [] OTHER [] CHARGE *

TOTAL LABOR.... 700.00
TOTAL PARTS.... 1148.80
TOTAL SUBLET... 0.00
TOTAL G.O.G.... 0.00
TOTAL MISC CHG. 0.00
TOTAL MISC DISC 0.00
TOTAL TAX..... 94.78

TOTAL INVOICE \$ 1943.58

CUSTOMER SIGNATURE

THANK YOU



PORSCHE

The Porsche Multi-Point Inspection Report

The Porsche Multi-Point Inspection Report is a series of thorough vehicle "health checks" performed by factory-trained Porsche technicians. It is designed to keep your Porsche operating in top condition and to minimize your chances of being inconvenienced on the road. If additional service is recommended on any listed item, your Porsche Service Advisor will be happy to speak with you about your options.

Customer Name _____ Year/Model _____ Engine Size _____

RO/Tag _____ Mileage _____ VIN _____ Date _____

Checked and Okay at this Time **May Require Future Attention** **Requires Immediate Attention**

Check Fluid Levels and Fill

OK FILL	OK FILL
<input type="checkbox"/> <input type="checkbox"/> Engine Oil	<input type="checkbox"/> <input type="checkbox"/> Brake Reservoir
<input type="checkbox"/> <input type="checkbox"/> Windshield Washer	<input type="checkbox"/> <input type="checkbox"/> Headlamp Washer
<input type="checkbox"/> <input type="checkbox"/> Power Steering	<input type="checkbox"/> <input type="checkbox"/> Coolant Recovery Reservoir
<input type="checkbox"/> <input type="checkbox"/> Transmission (if equipped w/ dipstick)	

Check Following Systems / Components

- Operation of horn, interior lights, exterior lamps, turn signals, hazard and brake lamps
- Visually inspect headlamp alignment
- Windshield washer spray, wiper operation and wiper blades
- Windshield cracks and/or chips
- Heating, ventilation and air conditioning check
- Engine air cleaner filter
- Oil and/or fluid leaks
- Constant velocity (CV) drive axle boots (if equipped)
- Exhaust system (leaks, damage, loose parts)
- Steering and steering linkages
- Shocks/struts, air suspension and other suspension components for leaks and/or damage
- Brake system (including lines, hoses and parking brake)
- Engine cooling system, hoses and clamps
- Radiator, heater and air conditioning hoses for leaks / damage
- Accessory drive belt(s)
- Clutch operation (if equipped)
- State inspection due (if applicable) _____ / _____ / _____
Month Day Year
- Your last completed maintenance _____ ; _____ / _____
Mileage Month Year
- Your next factory scheduled maintenance is due at _____ / _____ / _____
Mileage Month Year

Comments: _____

This Courtesy Inspection Completed By Your Porsche Service Team

Service Advisor: _____

Technician: _____

Customer Signature: _____

Check Battery Condition

Good Recharge Bad

Comments: _____

Check Brakes

Measure Front / Rear Brake Linings

RF RR

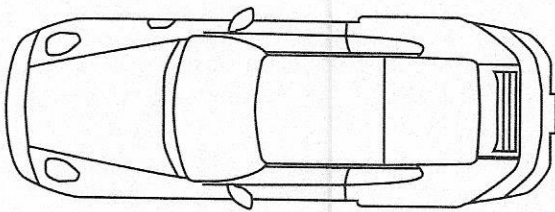

LF LR

Over 5mm or 7/32" _____

3 to 5mm or 4/32" to 7/32" _____

Less than 3mm or 4/32" _____

Brake Measurements Not Taken This Service Visit

Comments: _____

Check Tires

LF TREAD DEPTH RF

7/32" or Greater 7/32" or Greater

4/32" to 6/32" 4/32" to 6/32"

3/32" or Less 3/32" or Less



7/32" or Greater 7/32" or Greater

4/32" to 6/32" 4/32" to 6/32"

3/32" or Less 3/32" or Less

LR RR

LF Wear Pattern / Damage RF

LR Tire Wear Indicators RR

Alignment Check Recommended Wheel Balance Recommended

Comments: _____

Tire Pressure Set to _____

Factory Recommendations PSI _____ Front _____ Rear _____

PORSCHE MARIN

900 REDWOOD HIGHWAY • MILL VALLEY, CA 94941

Ph: (415) 380-8000

415-380-8000

PORSCHE

INVOICE

BAR # AA 219898

CPA#: CA0000836374

CUSTOMER NO. 210496	ADVISOR TRISTAN BAYLESS	1513	TAG NO. SMOG	INVOICE DATE 06/28/18	INVOICE NO. POCS470547
	LICENSE NO. 6GDY606		MILEAGE 29,768	COLOR SILVER/	STOCK NO.
	YEAR / MAKE / MODEL 10/PORSCHE/BOXSTER S/BOXSTER S			DELIVERY DATE 12/06/09	DELIVERY MILES
	VEHICLE I.D. NO. W P 0 C B 2 A 8 9 A U 7 3 0 1 8 3			SELLING DEALER NO.	PRODUCTION DATE 10/16/09
	F.T.E. NO.		P.O. NO.	R.O. DATE 06/28/18	
BUSINESS PHONE	COMMENTS				

MO: 29769

JOB# 1 CHARGES-----

LABOR-----
 J# 1 06POZZSMOG CA SMOG INSPECTION TECH(S):1417 76.75
 CLIENT REQUESTS CALIFORNIA STATE SMOG INSPECTION
 PERFORMED SMOG CERTIFATION INSPECTION HV283317C
 PASSED.

MISC-----CODE-----DESCRIPTION-----CONTROL NO-----
 SMOGCERT CA SMOG CERTIFICATE 8.25
 TOTAL - MISC 8.25

JOB# 1 TOTALS-----
 LABOR 76.75
 MISC 8.25

JOB# 2 CHARGES-----
 JOB# 1 JOURNAL PREFIX POCS JOB# 1 TOTAL 85.00

LABOR-----
 J# 2 04POZ1 TIRE INFLATION CHECK TECH(S):1417 INTERNAL
 CHECK AND INFLATE EACH VEHICLES TIRE TO THE RECOMMENDED
 INFLATION PRESSURE AND RECORD PRESSURE.
 CHECKED AND ADJUSTED ALL TIRES AS NEEDED
 SET TIRE PRESSURES.

JOB# 2 TOTALS-----
 JOB# 2 JOURNAL PREFIX POCS JOB# 2 TOTAL 0.00

ESTIMATE-----
 CUSTOMER HEREBY ACKNOWLEDGES RECEIVING
 ORIGINAL ESTIMATE OF \$85.00 (+TAX)
 COMMENTS-----
 WAITER

THANK YOU

PORSCHE MARIN

INVOICE

900 REDWOOD HIGHWAY • MILL VALLEY, CA 94941

Ph: (415) 380-8000

415-380-8000

PORSCHE

BAR # AA 219898

CPAL# CA00008363774

CUSTOMER NO. 210496	ADVISOR TRISTAN BAYLESS	1513	TAG NO. SMOG	INVOICE DATE 06/28/18	INVOICE NO. POCS470547
	LICENSE NO. 6GDY606		MILEAGE 29,768	COLOR SILVER/	STOCK NO.
SANTA ROSA, CA 95409	YEAR / MAKE / MODEL 10/PORSCHE/BOXSTER S/BOXSTER S			DELIVERY DATE 12/06/09	DELIVERY MILES
	VEHICLE I.D. NO. W P 0 C B 2 A 8 9 A U 7 3 0 1 8 3			SELLING DEALER NO.	PRODUCTION DATE 10/16/09
	F.T.E. NO.		P.O. NO.	R.O. DATE 06/28/18	
RESIDENCE PHONE	BUSINESS PHONE	COMMENTS			

MO: 29769

TOTALS-----

*****	TOTAL LABOR....	76.75
* [] CASH [] CHECK CK NO. [] *	TOTAL PARTS....	0.00
* [] VISA [] MASTERCARD *	TOTAL SUBLET...	0.00
* [] OTHER [] CHARGE *	TOTAL G.O.G....	0.00
*****	TOTAL MISC CHG.	8.25
	TOTAL MISC DISC	0.00
	TOTAL TAX.....	0.00
	TOTAL INVOICE \$	85.00

CUSTOMER SIGNATURE _____

THANK YOU



DISTRIBUTION CENTER
 2185 Airwest Blvd.
 Plainfield, IN 46168
 800-345-5789
 Fax 888-252-2252
 www.griotsgarage.com

RECEIPT



S
O
L
I
D
4657

S
H
I
P
T
O

ORDER NUMBER	ORDER DATE	CUSTOMER NUMBER	DATE	PURCHASE ORDER NUMBER
4878076	06/18/2018	1556413	06/20/2018	WB904288

PAYMENT TERMS	SHIP VIA	FOB	PAGE
Credit Card	Best Way Shipping	Shipping Pt	1

PICKING SEQUENCE	ITEM NUMBER	DESCRIPTION	QTY SHIPPED	QTY. B.O.	U.O.M.	UNIT PRICE	EXTENDED PRICE
016-2	10260	MICROFIBER DETAILING MITT	1	0	Ea	\$7.99	\$7.99
022-1	55526	PFM DETAILING TOWELS SET OF 3 16" X 9"	1	0	Ea	\$19.99	\$19.99
028-2	55582	PFM DUAL WEAVE GLASS TOWEL SET OF 4	1	0	Ea	\$19.99	\$19.99
032102	10984	SPRAY-ON CAR WASH 22 OUNCES	1	0	Ea	\$14.99	\$14.99
035206	11044	LONG LASTING TIRE DRESSING 16 OZ **NO AIR SHIPMENT**	1	0	Ea	\$18.99	\$18.99
035304	10855	CONVERTIBLE TOP CLEANER 22 OZ	1	0	Ea	\$9.99	\$9.99
038305	10960	FABRIC PROTECTANT 22 OZ	1	0	Ea	\$15.99	\$15.99
042304	15597	LUG NUT CLEANING BRUSH	1	0	Ea	\$17.99	\$17.99
046102	15690	COMPACT BENDABLE WHEEL BRUSH	1	0	Ea	\$15.99	\$15.99
047104	10973	HEAVY-DUTY WHEEL CLEANER 22 OZ	1	0	Ea	\$17.99	\$17.99
107-1	55525	PFM DUAL WEAVE WAX REMOVAL TOWELS SET OF 4	1	0	Ea	\$19.99	\$19.99
181-1	11290	SET OF 2 MICROFIBER WASH PADS	1	0	Ea	\$14.99	\$14.99
182-2	11231	SPEED SHINE CLOTHS SET OF 3 MICROFIBER	1	0	Ea	\$9.99	\$9.99
183-1	10975	INTERIOR DETAILER 22 OUNCES	1	0	Ea	\$10.99	\$10.99
185-1	10950	SPEED SHINE 22 OUNCES	1	0	Ea	\$10.99	\$10.99
HAZ-04	10998	ULTRA-PREMIUM GLASS CLEANER 19 OZ **NO AIR SHIPMENT**	1	0	Ea	\$5.99	\$5.99

SUBTOTAL	TAX	FREIGHT	TOTAL
\$232.84	\$20.09	\$0.00	\$252.93

Have fun in your garage!®

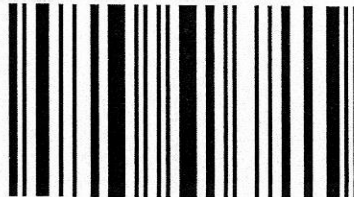

Griot's Garage
 Ord:4878076
 To :Imboden, Stephen G
 Via:Best Way Shipping



Griot's Garage
 Ord:4878076
 To :Imboden, Stephen G
 Via:Best Way Shipping



Griot's Garage
 Ord:4878076
 To :Imboden, Stephen G
 Via:Best Way Shipping

REPAIR ORDER

DE JUNG MOTORSPORT
459 PORTAL ST SUITE A
COTATI, CA 94931
707-664-8002
BAR #ARD 101025
EPA# CAL000064429

R/O # : 17419

Name

Date : 06/15/2018

License # : 6GDY606

Make : PORSCHE

Model : BOXSTER S

Year : 10

Odometer : 29454

Save Parts : NO

VIN : WPOCB2A89AU730183

, CA

Home:

Work:

Other:

LABOR

AMOUNT

Change engine oil and filter.
Check transaxle oil level.
Inspect brakes.
Check tire pressures.
Check lights.
Check brake fluid level.
Check coolant level.
Reset service light.

120.00

Read out fault codes:

DME, no codes
PDK, C418, C155, C146
PSM, no codes
Instrument Cluster, no codes
VES, no codes
Airbag, C152, C150
SWE, no codes
AC, 8023
Gateway, no codes
P Access System, 8005
Ft Bod Mod, 8024, 8025
Rr Bod Mod, C12
L Door Mod, no codes
R Door Mod, no codes
Seat Memory, C102

.00

Read out Readiness Monitors:

3 of 5 FAIL

Erase all fault codes.

REPAIR ORDER

DE JUNG MOTORSPORT
 459 PORTAL ST SUITE A
 COTATI, CA 94931
 707-664-8002
 BAR #ARD 101025
 EPA# CAL000064429

R/O # : 17419

Page : 2

Name _____

Date : 06/15/2018

License # : 6GDY606

Make : PORSCHE

Model : BOXSTER S

Year : 10

Odometer : 29454

Save Parts : NO

VIN : WPOCB2A89AU730183

 , CA

Home: _____

Work: _____

Other _____

LABOR

Hydraulic flush

AMOUNT

120.00

PARTS All parts new unless stated used or remanufactured

	PRICE	QTY	AMOUNT
9A1 107 224 00 OIL FILTER	30.20	1	30.20
G 052 195 1Q DSP OIL	8.83	9	79.47
01 TECHRON	9.00	1	9.00
4601824 COPPER WASHER	1.08	1	1.08
AB BRAKE FLUID P/LITER	22.87	1	22.87

SUBLETS

Inspection

AMOUNT

.00

Original Estimate : 399.30

Increases to Estimate

Date	Time	OK'd By	Phone	Emp.	Increase

LABOR	240.00
PARTS	142.62
SUBLETS	.00
CALIF BATTERY TAX	.00
HAZARDOUS MATERIALS	4.30
SUB TOTAL	386.92
TAX	13.01
TOTAL	399.93

Parts & labor conditionally guaranteed 4,000 mi./ 90 days.

I hereby authorize DEJUNG MOTORSPORT to perform the repair work listed above along with necessary materials. You and your employees may operate the above vehicle for purposes of testing, inspection, or delivery at my risk. An express mechanics lien is acknowledged on above vehicle to secure the amount of repairs. Thereto it is understood that this company assumes no responsibility for loss or damage by theft or fire to vehicles placed with them for storage, sale, repair, or while road testing.

Authorized by : _____ Date : _____

Porsche Boxter S, 2010:

Vanity Lisc ideas: 4EVRFUN, WICK. PUTPUT

Ray Ramsey, Porsche of Monterey

Vin: WP0CB2A89AU730183

Purchased 8/17/2013

Lisc# 6GDY606

Mileage 15,516

Warrantied until December 6, 2015 or 100K miles.

First purchaser history:

Originally purchased 12/04/2009.

First oil change - 5,234 on 12/20/2010

2nd oil change & brake system flush - 9,905 on 12/16/11. 3rd oil change - 13,295 on 12/05/12.

RGW purchased 08/17/2013

08/19/13 - 15,516, updated PCM Nav

09/05/13 - 16,215

09/15/13 - 16,695

10/04/13 - 16,802

10/25/13 - 17,165

11/20/13 - 17,629

12/13/13 - 17,772

01/17/14 - 18,520

01/24/14 - 18,697, 20K Service, oil/filter change, brake system flush & fluid replacement, pads at 90% front & 85% rear, tires 4.5 mm front, 4mm rear. \$425.69 @ Sonnen Porsche in San Rafael.

02/15/14 - 19,003

02/23/14 - 19,120

03/15/14 - 19,223

04/03/14 - 19,773

05/01/14 - 19,857

06/08/14 - 20,290

06/26/14 - 21,001

08/07/14 - 21,256

08/27/14 - 21,623

09/12/14 - 21,717

10/15/14 - 22,045

11/14/14 - 22,108 Registration for December 2015, \$381.

12/01/14 - 22,108

01/03/15 - 22,403

02/23/15 - 22,753 Oil/filter change, courtesy inspection, PCM check - programming problems. Updated PCM software. \$208.47.

03/05/15 - 22,883

04/11/15 - 23,183

04/28/15 - 23,272

05/28/15 - 23,369

06/12/15 - 23,401

07/01/15 - 23,633

07/22/15 - 24,056 New Tires, installed at Porsche of Monterey. Michelin Super Sport. \$1,259.09 installed. 45 Months remaining on tire pressure sensors. 29 MPG on trip to/from Monterey.

07/23/15 - 24,244

10/01/15 - 24,864

10/08/15 - 24,864 New Battery, installed at Sonnen Porsche in Mill Valley. \$317.99.

10/30/15 - 24,955

11/30/15 - 25,108 Checkup before expiration of CPO warranty. Starts without pressing on brake. Replaced "Rear-End Control Unit" - Fixed. Radio volume does not change with vehicle speed - Replaced PCM - fixed (dealer said that it is barely noticeable). Very slight ding on rear bumper pad, which was caused during prior service at Sonnen Porsche of Mill Valley - Fixed. All no charge by dealer.

12/09/15 - 25,265

01/07/16 - 25,497

02/27/16 - 26,055

03/08/16 - 26,121 Oil/filter change, brake system flush & fluid replacement, courtesy inspection. \$521.88. Sonnen Porsche, Mill Valley.

04/02/16 - 26,205

04/05/16 - 26,255

05/07/16 - 26,279

06/03/16 - 26,375

06/24/16 - 26,382

06/30/16 - 26,425

07/05/16 - 26,706

09/20/16 - 26,830

10/02/16 - 26,883

10/29/16 - 26,913

11/20/16 - 27,026

12/02/16 - 27,110

12/31/16 - 27,226

01/16/17 - 27,314

03/09/17 - 27,392 Oil change, multi point inspection \$262.54. Sonnen Porsche, Mill Valley.

03/26/17 - 27,575

05/02/17 - 27,709

06/25/17 - 27,766

07/01/17 - 27,771

07/20/17 - 28,212

08/20/17 - 28,605

12/11/17 - 28,827

02/16/18 - 29,113

03/28/18 - 29,129

06/08/18 - 29,299

Gary Wright - Sonnen Porsche

Email: gary.wright@sonnenporsche.com/16

Direct Number: 415-381-7822

Service # (415) 380-8000

Bruce Canepa, cvc.

Assistant: Phyllis

4900 SCOTTS VALLEY DRIVE

SCOTTS VALLEY, CA. 95066

831-430-9940

Xqzxr

Hu u

SONNEN PORSCHE

900 REDWOOD HIGHWAY • MILL VALLEY, CA 94941

Ph: (415) 380-8000

PORSCHE

415-380-8000

INVOICE

BAR # AA 219898

~~EPA # CA100929169352~~

CUSTOMER NO. 155006	ADVISOR RUSSELL FONG	TAG NO. 1346 3055	INVOICE DATE 03/09/17	INVOICE NO. POCS433876
	LICENSE NO. 6GDY606	MILEAGE 27,392	COLOR SILVER/	STOCK NO.
RESIDENCE PHONE [REDACTED]	YEAR / MAKE / MODEL 10/PORSCHE/BOXSTER S/BOXSTER S	DELIVERY DATE 12/06/09	DELIVERY MILES	PRODUCTION DATE
BUSINESS PHONE [REDACTED]	VEHICLE I.D. NO. WP0CB2A89AU730183	SELLING DEALER NO.		
	F.T.E. NO.	P.O. NO.	R.O. DATE 03/09/17	
	COMMENTS			

MO: 27392

JOB# 1 CHARGES-----

LABOR-----
J# 1 03POZ OIL CHNG / GEN MAINT TECH(S):2064 161.50
 OIL AND FILTER CHANGE, CHECK AND SET TIRE PRESSURE, TOP OFF
 FLUID LEVELS
 --- RESET SERVICE LIGHT ---
 COMPLETED OIL CHANGE SERVICE

PARTS-----QTY---FP-NUMBER-----DESCRIPTION-----UNIT PRICE-
 1 9A1-107-224-00 OIL-FILTER INSER 30.20 30.20
 1 900-123-106-30 ALUM SEAL RING 1.47 1.47
 9 040 MOBILE1 0W40 6.99 62.91
 1 CRC PART WASH 4.95 4.95
 1 996-107-313-51 O-RING 10.07 10.07
 TOTAL - PARTS 109.60

MISC-----CODE-----DESCRIPTION-----CONTROL NO-----
 P-WOF PORSCHE HAZ WASTE/OIL & FILTER 4.50
 P-DP DISCOUNT PARTS -22.10
 TOTAL - MISC -17.60

JOB# 1 TOTALS-----
 LABOR 161.50
 PARTS 109.60
 MISC -17.60

JOB# 2 CHARGES----- JOB# 1 JOURNAL PREFIX POCS JOB# 1 TOTAL 253.50

LABOR-----
J# 2 03POZ002 MULTI-POINT INSPECT TECH(S):2064 0.00
 PERFORM COURTESY INSPECTION AS REQUESTED.CHECK BRAKES,TIRES,
 AND ALL EXTERIOR LIGHTS.CHECK OIL,BRAKE,COOLANT,AND WASHER
 FLUID LEVELS.PLEASE NOTE RESULTS BELOW
 PERFORMED INSPECTIONS AS PER ATTACHED CHECKLIST

JOB# 2 TOTALS-----

JOB# 3 CHARGES----- JOB# 2 JOURNAL PREFIX POCS JOB# 2 TOTAL 0.00

LABOR-----
J# 3 04POZ1 TIRE INFLATION CHECK TECH(S):2064 0.00
 CHECK AND INFLATE EACH VEHICLES TIRE TO THE RECOMMENDED
 INFLATION PRESSURE AND RECORD PRESSURE.
 CHECKED AND ADJUSTED ALL TIRES AS NEEDED

JOB# 3 TOTALS-----

JOB# 3 JOURNAL PREFIX POCS JOB# 3 TOTAL 0.00

ESTIMATE-----
 CUSTOMER HEREBY ACKNOWLEDGES RECEIVING
 ORIGINAL ESTIMATE OF \$255.00 (+TAX)

THANK YOU

SONNEN PORSCHE

900 REDWOOD HIGHWAY • MILL VALLEY, CA 94941

Ph: (415) 380-8000

PORSCHE

415-380-8000

INVOICE

BAR # AA 219898

CUSTOMER NO. 155006	ADVISOR RUSSELL FONG	TAG NO. 1346 3055	INVOICE DATE 03/09/17	INVOICE NO. CPA # C7D70023169352
	LICENSE NO. 6GDY606	MILEAGE 27,392	COLOR SILVER/	STOCK NO. POCS433876
YEAR / MAKE / MODEL 10/PORSCHE/BOXSTER S/BOXSTER S	VEHICLE I.D. NO. W P 0 C B 2 A 8 9 A U 7 3 0 1 8 3	DELIVERY DATE 12/06/09	SELLING DEALER NO.	DELIVERY MILES
SONOMA, CA 95476-7671	F.P.E. NO.	P.O. NO.	R.O. DATE 03/09/17	PRODUCTION DATE
Business PHONE	COMMENTS			

MO: 27392

COMMENTS
DECLINED CAR WASH

TOTALS-----

*****	TOTAL LABOR....	161.50
* [] CASH [] CHECK CK NO. [] *	TOTAL PARTS....	109.60
* [] VISA [] MASTERCARD *	TOTAL SUBLET...	0.00
* [] OTHER [] CHARGE *	TOTAL G.O.G....	0.00
*****	TOTAL MISC CHG.	4.50
	TOTAL MISC DISC	-22.10
	TOTAL TAX.....	9.04
	TOTAL INVOICE \$	262.54

CUSTOMER SIGNATURE _____

THANK YOU



PORSCHE

The Porsche Multi-Point Inspection Report

The Porsche Multi-Point Inspection Report is a series of thorough vehicle "health checks" performed by factory-trained Porsche technicians. It is designed to keep your Porsche operating in top condition and to minimize your chances of being inconvenienced on the road. If additional service is recommended on any listed item, your Porsche Service Advisor will be happy to speak with you about your options.

Customer Name _____ Year/Model _____ Engine Size _____

RO/Tag _____ Mileage _____ VIN _____ Date _____

Checked and Okay at this Time **May Require Future Attention** **Requires Immediate Attention**

Check Fluid Levels and Fill

- | | |
|--|--|
| OK FILL | OK FILL |
| <input checked="" type="checkbox"/> Engine Oil | <input checked="" type="checkbox"/> Brake Reservoir |
| <input checked="" type="checkbox"/> Windshield Washer | <input checked="" type="checkbox"/> Headlamp Washer |
| <input checked="" type="checkbox"/> Power Steering | <input checked="" type="checkbox"/> Coolant Recovery Reservoir |
| <input checked="" type="checkbox"/> Transmission (if equipped w/ dipstick) | |

Check Following Systems / Components

- Operation of horn, interior lights, exterior lamps, turn signals, hazard and brake lamps
- Visually inspect headlamp alignment
- Windshield washer spray, wiper operation and wiper blades
- Windshield cracks and/or chips
- Heating, ventilation and air conditioning check
- Engine air cleaner filter
- Oil and/or fluid leaks
- Constant velocity (CV) drive axle boots (if equipped)
- Exhaust system (leaks, damage, loose parts)
- Steering and steering linkages
- Shocks/struts, air suspension and other suspension components for leaks and/or damage
- Brake system (including lines, hoses and parking brake)
- Engine cooling system, hoses and clamps
- Radiator, heater and air conditioning hoses for leaks / damage
- Accessory drive belt(s)
- Clutch operation (if equipped)
- State inspection due (if applicable) _____ / _____ / _____
Month Day Year
- Your last completed maintenance _____ Mileage ; _____ / _____
Month Year
- Your next factory scheduled maintenance is due at _____ Mileage ; _____ / _____
Month Year

Comments: _____

Check Battery Condition

- Good Recharge Bad
- Comments: _____

Check Brakes

Measure Front / Rear Brake Linings

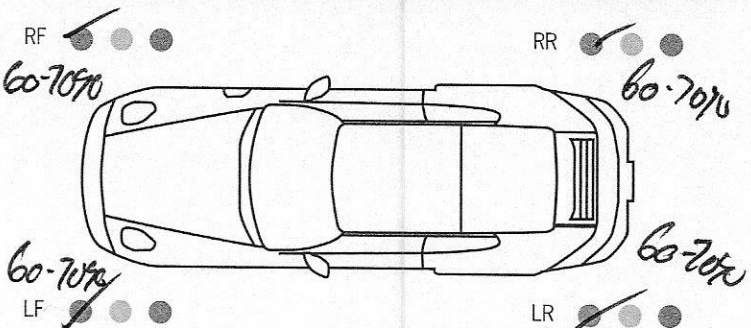

- Over 5mm or 7/32"
- 3 to 5mm or 4/32" to 7/32"
- Less than 3mm or 4/32"

Brake Measurements Not Taken This Service Visit

Comments: _____

Check Tires

- TREAD DEPTH
- | | | | |
|----|--|----|--|
| LF | <input checked="" type="checkbox"/> 7/32" or Greater | RF | <input checked="" type="checkbox"/> 7/32" or Greater |
| | <input type="checkbox"/> 4/32" to 6/32" | | <input type="checkbox"/> 4/32" to 6/32" |
| | <input type="checkbox"/> 3/32" or Less | | <input type="checkbox"/> 3/32" or Less |
| LR | <input checked="" type="checkbox"/> 7/32" or Greater | RR | <input checked="" type="checkbox"/> 7/32" or Greater |
| | <input type="checkbox"/> 4/32" to 6/32" | | <input type="checkbox"/> 4/32" to 6/32" |
| | <input type="checkbox"/> 3/32" or Less | | <input type="checkbox"/> 3/32" or Less |



- LF RF Wear Pattern / Damage
- LR RR Tire Wear Indicators

Alignment Check Recommended Wheel Balance Recommended

Comments: _____

This Courtesy Inspection Completed By Your Porsche Service Team

Service Advisor: _____

Technician: [Signature]

Customer Signature: _____

Tire Pressure Set to _____ PSI Front Rear

PORSCHE MARIN

900 Redwood Highway • Mill Valley, CA 94941

Ph: (415) 380-8000

WORK ORDER

BAR# ARD219898
EPA# CAL00023433

RECOMMENDED SERVICES

OPERATION	OPERATION DESCRIPTION	MO/MI	TOTAL	OPERATION	OPERATION DESCRIPTION	MO/MI	TOTAL

SERVICE HISTORY

DATE	REPAIR ORDER	MILEAGE	ADVISOR	TECHNICIAN	TYPE	OPERATION	OPERATION DESCRIPTION
08/04/16	417523	2664	1513	2064	I	46POZZ	BRAKE SYSTEM CONCERN
03/08/16	405893	2612	942	2064 98 2064 2064 2064	I I C I C	20POZ 99POZZRENTAL 03POZ 03POZ002 46POZZ02	DRIVABILITY CONCERN INTERNAL RENTAL OIL CHNG / GEN MAINT MULTI-POINT INSPECT BRAKE FLUID SERVICE

SALESPERSON NO. _____

S E R V I C E

STATE REG# AG133681

VEHICLE NO. WP0CB2A89AU730183	YEAR/MAKE/MODEL 10/PORSCHE/BOXSTER S/BOXSTER S	PRODUCTION DATE	STOCK NO.	LICENSE NO. 6GDY606	REG. DATE 03/09/17
CUSTOMER NO. 155006	SERVICE CONTRACT PORSCHE	DELIVERY DATE 12/06/09	DELIVERY MILES	SELLING DEALER NO.	R. O. DATE
COLOR SILVER/	CONTRACT NO. AU730183	EXPIRATION DATE 12/08/15	EXPIRATION MILES 100,000	SALES NO. 3055	
TURBO N	MM POZZ	R COND P.S.	Y TRANS A	MILEAGE 27,392	ADVISOR NO. 1346
ADVISOR RUSSELL FONG	REPAIR AUTHORIZATION & VEHICLE DEPOSITARY RECEIPT (AB 409 amending civil code) I hereby authorize the repair work to be done along with the necessary materials. You and your employees may operate vehicle for purpose of testing, inspection or delivery at my risk. An express mechanic's lien is acknowledged on vehicle to secure the amount of repairs thereto. In the event legal action is necessary to enforce this contract, I will pay reasonable attorney's fees and court costs. I acknowledge this deposited property is not insured or protected to the amount of actual cash value thereof by the dealer against loss occasioned by theft, fire and vandalism while such property remains with the depository. I also acknowledge no articles of personal property remains with the depository. I also acknowledge no articles of personal property have been left in vehicle and the dealer is not responsible for the inspection thereof.				
RECEIVED DATE 08/14/16	DATE TIME USED 03/09/17 06:00pm	PRIORITY			
APPOINTMENT <input checked="" type="checkbox"/> Yes <input type="checkbox"/> No	MILEAGE OUT CELL: 707-529-9352	<input checked="" type="checkbox"/> SAVE PARTS			

ORIGINAL CUSTOMER ESTIMATE: TOTAL 255.00

ORIGINAL ESTIMATE HAZARDOUS WASTE REMOVAL EST. \$

TEARDOWN ESTIMATE
I understand that my vehicle will be reassembled within _____ days of the date shown above if I choose not to authorize the services recommended.

1ST REV. EST. ADD. COST AUTHORIZED BY:

DATE TIME PHONE CONTACTED BY:
 IN PERSON BY FAX
 BY PHONE BY EMAIL

REVISION DETAILS:

1ST REV. EST. ADD. COST AUTHORIZED BY:

DATE TIME PHONE CONTACTED BY:
 IN PERSON BY FAX
 BY PHONE BY EMAIL

REVISION DETAILS:

I acknowledge notice and oral approval of an increase in the original estimate

CUSTOMER SIGNATURE
I hereby designate the individual named below to authorize any additional work not specified or parts not included in the original written estimated price for parts and labor

Name of Designee: Phone Number:
E-Mail Address: Fax Number:

Customer's Signature Date

BY LAW, YOU MAY CHOOSE ANOTHER FACILITY TO PERFORM ANY NEEDED REPAIRS OR ADJUSTMENTS WHICH THE SMOG CHECK TEST INDICATES ARE NECESSARY

ALL PARTS REMOVED WILL BE DISCARDED UNLESS OTHERWISE REQUESTED PRIOR TO BEGINNING WORK.

ALL PARTS ARE NEW OR FACTORY REMANUFACTURED UNLESS OTHERWISE SPECIFIED.

COMMENTS :

1 **C * 03POZ OIL CHNG / GEN MAINT**
OIL AND FILTER CHANGE, CHECK AND SET TIRE PRESSURE, TOP OFF FLUID LEVELS
--- RESET SERVICE LIGHT ---

2 **C * 03POZ002 MULTI-POINT INSPECT**
PERFORM COURTESY INSPECTION AS REQUESTED. CHECK BRAKES, TIRES, AND ALL EXTERIOR LIGHTS. CHECK OIL, BRAKE, COOLANT, AND WASHER FLUID LEVELS. PLEASE NOTE RESULTS BELOW

3 **C 04POZ1 TIRE INFLATION CHECK**
CHECK AND INFLATE EACH VEHICLES TIRE TO THE RECOMMENDED INFLATION PRESSURE AND RECORD PRESSURE.

Smog Check Vehicle Inspection Report (VIR)

Vehicle Information

Test Date/Time: 11/30/2016 @ 2:07 PM

Model Year: 2010	Vehicle Make: PORSCHE	Vehicle Model: BOXSTER S
VIN (manually entered or from DMV document): WP0CB2A89AU730183		
License Plate: 6GDY606	License State: CA	Fuel Type: Gasoline
Certification Type: California	Odometer: 27039	

Overall Test Result

PASS

Congratulations! Your vehicle passed the Smog Check inspection, which helps California reach its daily goal of removing smog-forming emissions from the air. Thank you for keeping your vehicle well maintained.

Visual Inspection: PASS Functional Inspection: PASS

Smog Check Certificate Number: ZL194958C

DMV ID Number: 8186L313Z693

Your Smog Check certificate has been electronically transmitted to DMV.

Your certificate is valid for 90 days from date of issuance.

Please keep this copy for your records.

Visual Inspection Result Information

<u>Result</u>	<u>Inspection Category</u>	<u>Result</u>	<u>Inspection Category</u>
NOTAPPLICABLE	Air Injection System	PASS	Catalyst
PASS	Computers, Sensors, Switches, and Wiring	PASS	Crankcase Emission Controls
PASS	Exhaust Gas Recirculation (EGR)	PASS	Fuel Evaporative System (EVAP)
PASS	Fuel Metering System	PASS	Other Emission Related Components/Systems
NOTAPPLICABLE	Turbocharger/Supercharger	PASS	Vacuum Lines to Sensors/Switches

Emission Control Systems Functional Check Results

<u>Result</u>		<u>Result</u>	
PASS	Liquid Fuel Leak Check	PASS	OBDII
PASS	Smoke Check		

Smog Check Inspection Station Information

Station ID: RC225698	Inspector Name/ID: VAZQUEZ, EZEQUIEL/EO636056
BONNEAUS TOWING & MECHANICAL LLC	Software Version/OIS ID: 6.7.992.0/CV010389
23003 ARNOLD DRIVE	
SONOMA, CA 95476	
(707) 938-8133	

I certify, under penalty of perjury, under the laws of the State of California, that I performed the inspection in accordance with all bureau requirements, and that the information listed on this vehicle inspection report is true and accurate.

11/30/16

Date

Inspector's Signature

SERVICE ORDER

00000000000
0000 - A31689

DEALER BONNEAU'S TOWING & MECHANICAL 23003 ARNOLD DR SONOMA CA 95476 (707) 938-8133 BAR #AA225698 E.P.A. NUM		CUSTOMERS NAME & ADDRESS <div style="background-color: black; width: 100px; height: 15px;"></div> SONOMA CA <div style="background-color: black; width: 100px; height: 15px;"></div> 95476 - <div style="background-color: black; width: 100px; height: 15px;"></div>		DATE & TIME 11/30/16 14 :14	WRITTEN BY: PROMISED: 11/ 30
---	--	---	--	--	--

VEHICLE LICENSE NO. 6GDY606	ODOMETER 27,039	VEHICLE DESCRIPTION 10POR 911..	VEHICLE IDENTIFICATION NO.
PAYMENT METHOD		<input type="checkbox"/> MCVISA	CREDIT CARD NO.
		<input type="checkbox"/> OTHER	CREDIT AUTHORIZATION

DELIVER
 WILL CALL
 CALL WHEN READY

SERVICE REPAIR INSTRUCTIONS/SYMPTOMS				SERVED BY DVH
				INSPECTED BY DVH

TECH	QTY	PART NO	REPAIR/SERVICE DESCRIPTION	PARTS	LABOR
VASQ!	00		SMOG INSPECTION By law, you may choose another facility to perform any needed repairs or adjustments which the Smog Check test indicates are necessary. SMOG DISC. SMOG CERTIFICATE ***** * THANK YOU! * * We appreciate your Business! * ***** <div style="text-align: center;"></div>		64.95
VASQ!	00			8.25	7.00-
VASQ!	00				

CUSTOMER REQUESTED RETURNED PARTS <input type="checkbox"/> YES <input checked="" type="checkbox"/> NO I, the registered owner, authorize you to perform the above repairs and furnish necessary materials. I understand any cost quoted heretofore is an estimate only. Your employees may operate vehicle for inspection, testing, delivery at my risk. You will not be responsible for loss or damages to vehicle or articles left in it. I agree to pay reasonable storage on vehicle left more than 48 hours after notification that repairs are completed. An express Mechanic's Lien is acknowledged on above vehicle to secure the amount of repairs thereto, including those from any prior work or repair contract on this vehicle. In the event an attorney is retained to foreclose on this lien or to bring suit for collection of any sums due, I agree to pay cost of collection and any reasonable attorney fees. Receipt of a copy of this order is hereby acknowledged.	SAFETY RECOMMENDATIONS				TOTALS		
	TRES	RF	LF	RR	LR	SPARE	
	TREAD						
	PSI						
CUSTOMER SIGNATURE X	BRAKES-F	%		BRAKES-R	%		
	BATTERY						
	COOLANT						
						TOTAL	66.20

REVISED	PARTS	LABOR	TOTAL	-DATE	TIME	<input type="checkbox"/> IN PERSON <input type="checkbox"/> BY PHONE	I ACKNOWLEDGE NOTICE AND ORAL APPROVAL OF AN INCREASE IN THE ORIGINAL ESTIMATED PRICE.
ESTIMATE	BY	AUTHORIZED BY CUSTOMER		PHONE NO.		X	

AMCOM-FWO-FORM-1/3

ALL PARTS NEW UNLESS OTHERWISE SPECIFIED

SONNEN PORSCHE

900 REDWOOD HIGHWAY • MILL VALLEY, CA 94941

Ph: (415) 380-8000

PORSCHE

415-380-8000

INVOICE

BAR # AA 219898

CPAL# C7D0028169352

CUSTOMER NO. 155006	ADVISOR TRISTAN BAYLESS	TAG NO. 1513	INVOICE DATE 08/05/16	INVOICE NO. POCS417523
	LICENSE NO. 6GDY606	MILEAGE 26,641	COLOR SILVER/	STOCK NO.
	YEAR / MAKE / MODEL 10/PORSCHE/BOXSTER S/BOXSTER S		DELIVERY DATE 12/06/09	DELIVERY MILES
RESIDENCE PHONE SONOMA, CA 95476-7671	VEHICLE I.D. NO. W P O C B 2 A 8 9 A U 7 3 0 1 8 3		SELLING DEALER NO.	PRODUCTION DATE
BUSINESS PHONE	F.T.E. NO.	P.O. NO.	R.O. DATE 08/04/16	
COMMENTS				

MO: 26644

JOB# 1 CHARGES-----

LABOR-----
J# 1 46P0ZZ BRAKE SYSTEM CONCERN TECH(S):2064 INTERNAL
 CLIENT STATES BRAKE PEDAL HAS BEEN SOFT AND SPONGEY SINCE PREVIOUS REPAIR - BRAKE FLUID FLUSH. INSPECT AND REPORT. OK TO PERFORM ANOTHER FLUSH IF COMPONENTS APPEAR OK VERIFIED CONCERN. POSSIBLE AIR IN SYSTEM FROM PREVIOUS FLUID FLUSH.
 PERFORMED BRAKE FLUID SYSTEM FLUSH AND RETESTED; PEDAL FIRMNESS HAS IMPROVED. ROAD TESTED; OK. OPERATING AS DESIGNED
 -- GOODWILL PORSCHE MARIN REPAIR --
 WE APOLOGISE FOR ANY INCONVENIENCE

JOB# 1 TOTALS-----

JOB# 2 CHARGES----- JOB# 1 JOURNAL PREFIX POCS JOB# 1 TOTAL 0.00

LABOR-----
J# 2 20P0Z DRIVABILITY CONCERN TECH(S):2064 INTERNAL
 CLIENT STATES VEHICLE WILL START DESPITE NOT HAVING FOOT ON THE BRAKE PEDAL. SEE HISTORY (REAR END CONTROL UNIT) INSPECT AND REPORT.
 FOUND TRANSMISSION CONTROL UNIT INCORRECTLY CODED TO 'TIPTRONIC' RATHER THAN TO 'PDK.'
 PERFORMED RECODING AS NEEDED. SET ADAPTATIONS AND ROAD TESTED; OK. BRAKE PEDAL NOW REQUIRES DEPRESSING TO START VEHICLE, AS DESIGNED.
 -- GOODWILL MARIN PORSCHE REPAIR --
 POSSIBLY RELATED TO PRIOR REAR END CONTROL UNIT REPLACEMENT.

JOB# 2 TOTALS-----

JOB# 3 CHARGES----- JOB# 2 JOURNAL PREFIX POCS JOB# 2 TOTAL 0.00

LABOR-----
J# 3 99P0ZZ RENTAL INTERNAL RENTAL TECH(S):98 INTERNAL
 CUSTOMER PROVIDED GOOD WILL RENTAL VEHICLE BY SONNEN PORSCHE.

SUBLET-----PO#-----VEND INV#-INV.DATE-DESCRIPTION-----
 70810 08/05/16 ENTERPRISE RENTAL INTERNAL
 TOTAL - SUBLET 0.00

JOB# 3 TOTALS-----

JOB# 3 JOURNAL PREFIX POCS JOB# 3 TOTAL 0.00

ESTIMATE-----
 CUSTOMER HEREBY ACKNOWLEDGES RECEIVING ORIGINAL ESTIMATE OF \$0.00 (+TAX)

THANK YOU

SONNEN PORSCHE

INVOICE

900 REDWOOD HIGHWAY • MILL VALLEY, CA 94941

Ph: (415) 380-8000

PORSCHE

415-380-8000

BAR # AA 219898

CPA # C707002369352

CUSTOMER NO. 155006	ADVISOR TRISTAN BAYLESS	TAG NO. 1513	INVOICE DATE 08/05/16	INVOICE NO. POCS417523
[REDACTED]	LICENSE NO. 6GDY606	MILEAGE 26,641	COLOR SILVER/	STOCK NO.
[REDACTED]	YEAR / MAKE / MODEL 10/PORSCHE/BOXSTER S/BOXSTER S	DELIVERY DATE 12/06/09	DELIVERY MILES	PRODUCTION DATE
[REDACTED]	VEHICLE I.D. NO. W P O C B 2 A 8 9 A U 7 3 0 1 8 3	SELLING DEALER NO.		
[REDACTED]	F.T.E. NO.	P.O. NO.	R.O. DATE 08/04/16	
RESIDENCE PHONE	BUSINESS PHONE	COMMENTS		

MO: 26644

COMMENTS-----
INTERNAL RENTAL

TOTALS-----

*****	TOTAL LABOR....	0.00
* [] CASH [] CHECK CK NO. [] *	TOTAL PARTS....	0.00
* [] VISA [] MASTERCARD *	TOTAL SUBLET...	0.00
* [] OTHER [] CHARGE *	TOTAL G.O.G....	0.00
*****	TOTAL MISC CHG.	0.00
	TOTAL MISC DISC	0.00
	TOTAL TAX.....	0.00
	TOTAL INVOICE \$	0.00

CUSTOMER SIGNATURE _____

THANK YOU

SONNEN PORSCHE

INVOICE

900 REDWOOD HIGHWAY • MILL VALLEY, CA 94941

Ph: (415) 380-8000

PORSCHE

415-380-8000

BAR # AA 219898

CUSTOMER NO. 155006	ADVISOR GARY WRIGHT	TAG NO. 2126	INVOICE DATE 03/08/16	INVOICE NO. POCS405893
[REDACTED]	LICENSE NO. 6GDY606	MILEAGE 26,121	COLOR SILVER/	STOCK NO.
SONOMA, CA 95476-7671	YEAR / MAKE / MODEL 10/PORSCHE/BOXSTER S/BOXSTER S	DELIVERY DATE 12/06/09	DELIVERY MILES	PRODUCTION DATE
[REDACTED]	VEHICLE I.D. NO. WP0CB2A89AU730183	SELLING DEALER NO.	COMMENTS	
[REDACTED]	F.T.E. NO.	P.O. NO.	R.O. DATE 03/08/16	

MO: 26122

JOB# 1 CHARGES-----

LABOR-----

1 03POZ OIL CHNG / GEN MAINT TECH(S):2064 185.00

OIL AND FILTER CHANGE, CHECK AND SET TIRE PRESSURE, TOP OFF
FLUID LEVELS
T100
--- RESET SERVICE LIGHT ---
COMPLETED OIL CHANGE SERVICE

PARTS-----

QTY	FP-NUMBER	DESCRIPTION	UNIT PRICE	PRICE
1	PK9A1LOF	9A1 LOF	****	****
1	900-123-106-30	ALUM SEAL RING	1.52	1.52
1	CRC	PART WASH	4.95	4.95
9	040	MOBILE1 0W40	6.99	62.91
1	996-107-313-51	O-RING	10.24	10.24
1	9A1-107-224-00	OIL-FILTER INSER	34.07	34.07
TOTAL - PARTS			113.69	

JOB# 1 TOTALS-----

LABOR 185.00
PARTS 113.69

JOB# 1 JOURNAL PREFIX POCS JOB# 1 TOTAL 298.69

JOB# 2 CHARGES-----

LABOR-----

2 03POZ002 MULTI-POINT INSPECT TECH(S):2064 INTERNAL

PERFORM COURTESY INSPECTION AS REQUESTED.CHECK BRAKES,TIRES,
AND ALL EXTERIOR LIGHTS.CHECK OIL,BRAKE,COOLANT,AND WASHER
FLUID LEVELS.PLEASE NOTE RESULTS BELOW
PERFORMED INSPECTIONS AS PER ATTACHED CHECKLIST

JOB# 2 TOTALS-----

JOB# 2 JOURNAL PREFIX POCS JOB# 2 TOTAL 0.00

JOB# 3 CHARGES-----

LABOR-----

3 46POZZ02 BRAKE FLUID SERVICE TECH(S):2064 168.57

CUSTOMER REQUESTS A BRAKE SYSTEM FLUSH AND FLUID
REPLACEMENT.
T100
COMPLETED BRAKE SYSTEM FLUSH AND FLUID REPLACEMENT.

PARTS-----

QTY	FP-NUMBER	DESCRIPTION	UNIT PRICE	PRICE
1	000-043-203-666	BRAKE FLUID	41.43	41.43
TOTAL - PARTS			41.43	

JOB# 3 TOTALS-----

LABOR 168.57
PARTS 41.43

JOB# 3 JOURNAL PREFIX POCS JOB# 3 TOTAL 210.00

THANK YOU

SONNEN PORSCHE

900 REDWOOD HIGHWAY • MILL VALLEY, CA 94941

Ph: (415) 380-8000

PORSCHE

415-380-8000

INVOICE

BAR # AA 219898

CUSTOMER NO. 155006	ADVISOR GARY WRIGHT	TAG NO. 2126	INVOICE DATE 03/08/16	CELL # 707 902 9935
	LICENSE NO. 942	MILEAGE 26,121	COLOR SILVER/	STOCK NO. POCS405893
	YEAR / MAKE / MODEL 10/PORSCHE/BOXSTER S/BOXSTER S	DELIVERY DATE 12/06/09	SELLING DEALER NO.	PRODUCTION DATE
	VEHICLE I.D. NO. W P 0 C B 2 A 8 9 A U 7 3 0 1 8 3	P.O. NO.	R.O. DATE 03/08/16	
	COMMENTS			

MO: 26122

ESTIMATE-----
 CUSTOMER HEREBY ACKNOWLEDGES RECEIVING
 ORIGINAL ESTIMATE OF \$525.00 (+TAX)

TOTALS-----

*****	TOTAL LABOR....	353.57
*	TOTAL PARTS....	155.12
* [] CASH [] CHECK CK NO. [] *	TOTAL SUBLET...	0.00
* [] VISA [] MASTERCARD *	TOTAL G.O.G....	0.00
* [] OTHER [] CHARGE *	TOTAL MISC CHG.	0.00
*****	TOTAL MISC DISC	0.00
	TOTAL TAX.....	13.19
	TOTAL INVOICE \$	521.88

CUSTOMER SIGNATURE _____

THANK YOU



PORSCHE

The Porsche Multi-Point Inspection Report

The Porsche Multi-Point Inspection Report is a series of thorough vehicle "health checks" performed by factory-trained Porsche technicians. It is designed to keep your Porsche operating in top condition and to minimize your chances of being inconvenienced on the road. If additional service is recommended on any listed item, your Porsche Service Advisor will be happy to speak with you about your options.

Customer Name _____ Year/Model _____ Engine Size _____

RO/Tag _____ Mileage _____ VIN _____ Date _____

Checked and Okay at this Time **May Require Future Attention** **Requires Immediate Attention**

Check Fluid Levels and Fill

OK FILL	OK FILL
<input checked="" type="checkbox"/> Engine Oil	<input checked="" type="checkbox"/> Brake Reservoir
<input checked="" type="checkbox"/> Windshield Washer	<input checked="" type="checkbox"/> Headlamp Washer
<input checked="" type="checkbox"/> Power Steering	<input checked="" type="checkbox"/> Coolant Recovery Reservoir
<input checked="" type="checkbox"/> Transmission (if equipped w/ dipstick)	

Check Following Systems / Components

- Operation of horn, interior lights, exterior lamps, turn signals, hazard and brake lamps
- Visually inspect headlamp alignment
- Windshield washer spray, wiper operation and wiper blades
- Windshield cracks and/or chips
- Heating, ventilation and air conditioning check
- Engine air cleaner filter
- Oil and/or fluid leaks
- Constant velocity (CV) drive axle boots (if equipped)
- Exhaust system (leaks, damage, loose parts)
- Steering and steering linkages
- Shocks/struts, air suspension and other suspension components for leaks and/or damage
- Brake system (including lines, hoses and parking brake)
- Engine cooling system, hoses and clamps
- Radiator, heater and air conditioning hoses for leaks / damage
- Accessory drive belt(s)
- Clutch operation (if equipped)
- State inspection due (if applicable) _____ / _____ / _____
Month Day Year
- Your last completed maintenance _____ Mileage ; _____ / _____
Month Year
- Your next factory scheduled maintenance is due at _____ Mileage ; _____ / _____
Month Year

Comments: _____

This Courtesy Inspection Completed By Your Porsche Service Team

Service Advisor: _____

Technician: *[Signature]*

Customer Signature: _____

PNA 000 012 ed. 05/08

Check Battery Condition

Good Recharge Bad

Comments: _____

Check Brakes

Measure Front / Rear Brake Linings

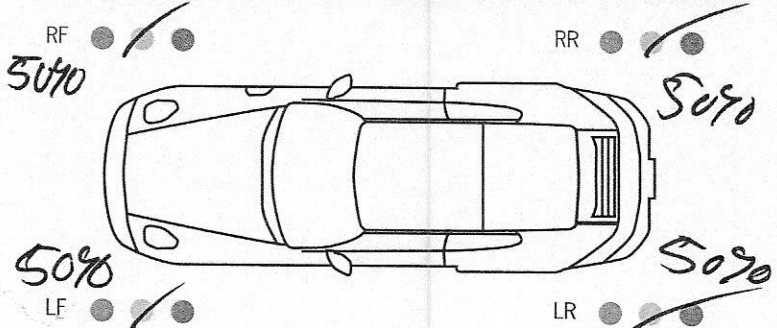

Over 5mm or 7/32" _____

3 to 5mm or 4/32" to 7/32" _____

Less than 3mm or 4/32" _____

Brake Measurements Not Taken This Service Visit

Comments: _____

Check Tires

LF	TREAD DEPTH	RF
<input checked="" type="checkbox"/> 7/32" or Greater		<input checked="" type="checkbox"/> 7/32" or Greater
<input type="checkbox"/> 4/32" to 6/32"		<input type="checkbox"/> 4/32" to 6/32"
<input type="checkbox"/> 3/32" or Less		<input type="checkbox"/> 3/32" or Less
<input checked="" type="checkbox"/> 7/32" or Greater		<input checked="" type="checkbox"/> 7/32" or Greater
<input type="checkbox"/> 4/32" to 6/32"		<input type="checkbox"/> 4/32" to 6/32"
<input type="checkbox"/> 3/32" or Less		<input type="checkbox"/> 3/32" or Less
LR		RR

LF RF RR

LR RR

Wear Pattern / Damage _____

Tire Wear Indicators _____

Alignment Check Recommended Wheel Balance Recommended

Comments: _____

Tire Pressure Set to _____ PSI

Factory Recommendations Front Rear

SONNEN PORSCHE

900 REDWOOD HIGHWAY • MILL VALLEY, CA 94941

Ph: (415) 380-8000

PORSCHE

415-380-8000

INVOICE

BAR # AA 219898

CPA # C7070023169352

CUSTOMER NO. 155006	ADVISOR GARY WRIGHT	TAG NO. 942 2990	INVOICE DATE 11/30/15	INVOICE NO. POCS397130
[REDACTED]	LICENSE NO. 6GDY606	MILEAGE 25,108	COLOR SILVER/	STOCK NO.
SONOMA, CA 95470	YEAR / MAKE / MODEL 10/PORSCHE/BOXSTER S/BOXSTER S	VEHICLE I.D. NO. W P O C B 2 A 8 9 A U 7 3 0 1 8 3	DELIVERY DATE 12/06/09	DELIVERY MILES
[REDACTED]	F.T.E. NO.	P.O. NO.	SELLING DEALER NO.	PRODUCTION DATE
RESIDENCE PHONE	BUSINESS PHONE	COMMENTS	R.O. DATE 11/13/15	

MO: 25110

JOB# 1 CHARGES-----

LABOR-----
J# 1 90POZ INSTRUMENTS TECH(S):1417 2096 WARRANTY
 CUSTOMER STATES THE ENGINE WILL START WITHOUT PRESSING THE BRAKE PEDAL.
 INTERNAL FAULT WITH IN REAR-END CONTROL UNIT, WILL NOT HOLD CODING AND VIN NUMBER.
 CREATED VAL, READ OUT FAULTS, FOUND NO COMMUNICATION WITH BRAKE LIGHT SWITCH FAULT, REMOVED BRAKED LIGHT SWITCH AND INSTALLED KNOWN GOOD PART, STILL ABLE TO START WITH OUT BRAK PEDAL IN PUT. PERFORMED VEHICLE HAND OVER,NOT OK, PERFORMED CIRCUIT TESTING FOR OPEN CIRCUITS BETWEEN SWITCH AND RELATED CONTROL UNITS (PSM,PAS AND REAR-END CONTROL UNITS) NO OPEN O SHORTS TO BATTERY OR GROUND FOUND, CHECKED ALL CODING AND FOUND REAR END WILL NOT HOLD CORRECT CODES AND VIN# FOR VEHICLE, REPLACED REAR-END CONTROL UNIT, RETESTED OK.

PARTS	QTY	FP-NUMBER	DESCRIPTION	UNIT PRICE	WARRANTY
	1	997-618-260-08	CONTROL UNIT, REA		WARRANTY
	1	996-613-113-02	PEDAL SWITCH, BR		WARRANTY
				TOTAL - PARTS	0.00

JOB# 1 TOTALS-----

JOB# 2 CHARGES----- JOB# 1 JOURNAL PREFIX POCs JOB# 1 TOTAL 0.00

LABOR-----
J# 2 38POZ AUTO TRANSMISSION TECH(S): 2096 INTERNAL
 CUSTOMER STATES THERE IS A CLUNK NOISE FROM THE TRANSMISSION WHEN SLOWING TO A STOP OR WHEN DRIVING FROM A STOP POSITION ON HILLS.
 NO ABNORMAL NOISES HEARD DURING ROAD TEST. PLEASE ADVISE SOME NOISE IS OK DURING OPERATION OF PDK.
 NO FURTHER ACTION TAKEN AT THIS TIME.

JOB# 2 TOTALS-----

JOB# 3 CHARGES----- JOB# 2 JOURNAL PREFIX POCs JOB# 2 TOTAL 0.00

LABOR-----
J# 3 91POZ ENTERTAINMENT SYSTEM TECH(S):1417 2096 WARRANTY
 CUSTOMER STATES THE RADIO VOLUME WILL NOT ADJUST WITH VEHICLE SPEED.
 FUNCTION SELECTED IN PCM. VERIFIED VOLUME DOES NOT CHANGE WITH VEHICLE SPEED.
 PERFORMED PCM UPDATE. ISSUE STILL PERSISTS.
 REPLACED PCM, RETESTED OK.

PARTS	QTY	FP-NUMBER	DESCRIPTION	UNIT PRICE	WARRANTY
	1	997-642-970-X-FTC	CONTROL PART		WARRANTY
	-1	997-642-970-X-FTC	CORE RETURN		WARRANTY

THANK YOU

SONNEN PORSCHE

900 REDWOOD HIGHWAY • MILL VALLEY, CA 94941

Ph: (415) 380-8000

PORSCHE

415-380-8000

INVOICE

BAR # AA 219898

CPAL # C707002369352

CUSTOMER NO. 155006	ADVISOR GARY WRIGHT	TAG NO. 942 2990	INVOICE DATE 11/30/15	INVOICE NO. POCS397130
	LICENSE NO. 6GDY606	MILEAGE 25,108	COLOR SILVER/	STOCK NO.
	YEAR / MAKE / MODEL 10/PORSCHE/BOXSTER S/BOXSTER S		DELIVERY DATE 12/06/09	DELIVERY MILES
	VEHICLE I.D. NO. W P O C B 2 A 8 9 A U 7 3 0 1 8 3		SELLING DEALER NO.	PRODUCTION DATE
	F.T.E. NO.	P.O. NO.	R.O. DATE 11/13/15	
RESIDENCE PHONE	BUSINESS PHONE	COMMENTS		

MO: 25110

TOTAL - PARTS 0.00

G.O.G. & SUPPLIES-----

FREIGHT (PARTS)

TOTAL - GOG WARRANTY 0.00

JOB# 3 TOTALS-----

JOB# 3 JOURNAL PREFIX POCs JOB# 3 TOTAL 0.00

JOB# 4 CHARGES-----

LABOR-----

J# 4 03POZ00032012I FREE WELLNESS CHECK TECH(S): 2096 INTERNAL
 PERFORM WELLNESS CHECK AS PER PORSCHE MULTI-POINT INSPECTION FORM -
 NOTE ALL MEASUREMENTS AND ADDITION REPAIRS AS NEEDED
 PERFORMED WELLNESS CHECK AS PER CHECK LIST

JOB# 4 TOTALS-----

JOB# 4 JOURNAL PREFIX POCs JOB# 4 TOTAL 0.00

JOB# 5 CHARGES-----

LABOR-----

J# 5+33POZZ06 SUBLET BODY SHOP TECH(S):98 INTERNAL
 SUBLET - REPAIR RIGHT REAR BUMPER PAD.
 LOT DAMAGE.
 SUBLET TO BARSOTTI'S BODY SHOP TO REPAIR.
 COMPLETED.

SUBLET-----PO#-----VEND INV#-INV.DATE-DESCRIPTION-----
 67850 25589 11/25/15 REPAIR REAR BUMPER PAD

TOTAL - SUBLET INTERNAL 0.00

JOB# 5 TOTALS-----

JOB# 5 JOURNAL PREFIX POCs JOB# 5 TOTAL 0.00

JOB# 6 CHARGES-----

LABOR-----

J# 6+99POZZLOANER PORSCHE LOANER TECH(S):98 0.00
 CUSTOMER PROVIDED LOANER VEHICLE.
 P2401 VIN#WP1AF2A28FLA37270

MISC-----CODE-----DESCRIPTION-----CONTROL NO-----
 P-RE PORSCHE RENTAL

TOTAL - MISC WARRANTY 0.00

JOB# 6 TOTALS-----

JOB# 6 JOURNAL PREFIX POCs JOB# 6 TOTAL 0.00

ESTIMATE-----

CUSTOMER HEREBY ACKNOWLEDGES RECEIVING ORIGINAL ESTIMATE OF \$0.00 (+TAX)

THANK YOU

SONNEN PORSCHE

900 REDWOOD HIGHWAY • MILL VALLEY, CA 94941

Ph: (415) 380-8000

415-380-8000

PORSCHE

INVOICE

BAR # AA 219898

CPAL # CA07002369352

CUSTOMER NO. 155006	ADVISOR GARY WRIGHT	TAG NO. 942 2990	INVOICE DATE 11/30/15	INVOICE NO. POCS397130
	LICENSE NO. 6GDY606	MILEAGE 25,108	COLOR SILVER/	STOCK NO.
	YEAR / MAKE / MODEL 10/PORSCHE/BOXSTER S/BOXSTER S		DELIVERY DATE 12/06/09	DELIVERY MILES
	VEHICLE I.D. NO. W P 0 C B 2 A 8 9 A U 7 3 0 1 8 3		SELLING DEALER NO.	PRODUCTION DATE
	F.T.E. NO.	P.O. NO.	R.O. DATE 11/13/15	
RESIDENCE PHONE	BUSINESS PHONE	COMMENTS		

MO: 25110

COMMENTS-----

eter. Recently you installed a new battery and you can turn the key and start the engine without stepping on the brake. This needs to be corrected as well.

DELETED OPERATION(S)-----
99POZZAUDI INTERNAL AUDI LOANER

TOTALS-----

*****	TOTAL LABOR....	0.00
* [] CASH [] CHECK CK NO. [] *	TOTAL PARTS....	0.00
* [] VISA [] MASTERCARD *	TOTAL SUBLET...	0.00
* [] OTHER [] CHARGE *	TOTAL G.O.G....	0.00
*****	TOTAL MISC CHG.	0.00
	TOTAL MISC DISC	0.00
	TOTAL TAX.....	0.00
	TOTAL INVOICE \$	0.00

CUSTOMER SIGNATURE _____

THANK YOU



PORSCHE OF MONTEREY #184

1781 DEL MONTE BLVD.
SEASIDE, CA 93955
PHONE: (831) 899-8888
FAX: (831) 583-6262

PORSCHE

REMIT PAYMENT TO: LITHIA MOTORS PAYMENT PROCESSING
P.O. BOX 1647 · MEDFORD, OR 97501-0249

POSITIVELY NO EXCHANGES WITHOUT THIS TICKET
T NO REFUNDS ON SPECIAL ORDERS
E 20% HANDLING CHARGE ON ALL RETURNED PARTS
R NO RETURNS ON ELECTRICAL PARTS
M REFUND ON PURCHASES PAID BY CHECK ARE
S REFUNDED AFTER CHECK CLEARS
PRICES SUBJECT TO CHANGE WITHOUT NOTICE

DATE ENTERED 28 SEP 15	YOUR ORDER NO.	DATE SHIPPED 28 SEP 15	INVOICE DATE 28 SEP 15	INVOICE NUMBER 19839
---------------------------	----------------	---------------------------	---------------------------	-------------------------

S
O
L
D
T
O

CASH

ACCOUNT NO. 99

S
H
I
P
T
O

CASH

PAGE 1 OF 1

SHIP VIA		SLSM. 173149	B/L NO.	TERMS CASH	F.O.B. SEASIDE, CA		
ORD.	SHIP	B.O.	PART NUMBER	DESCRIPTION	LIST	NET	AMOUNT
1	1	0	996-628-901-08	180 WIPER	64.35	57.91	57.91

PAID

SEP 28 2015

PORSCHE OF MONTEREY

COM

If legal action becomes necessary to collect payment for the above parts or any additional parts authorized by the customer, the prevailing party shall be entitled to recover reasonable attorney's fees and costs incurred in such collection action, including any appeal.

Received By

STATEMENT OF DISCLAIMER AND ARBITRATION AGREEMENT

The factory warranty constitutes all of the warranties with respect to the sale of this item/items. The Seller hereby expressly disclaims all warranties either express or implied, including any implied warranty of merchantability or fitness for a particular purpose. Seller neither assumes nor authorizes any other person to assume for it any liability in connection with the sale of this item/items. Seller dispute between customer and the dealership arising from or related to this vehicle or this transaction will be settled by mandatory and binding arbitration pursuant to the Federal Arbitration Act 9 U.S.C § 1 et. seq. The arbitration shall be conducted by a single arbitrator. The arbitrator may grant whatever relief the parties may be entitled to at law or in equity.

PARTS	57.91
SUBLET	
FREIGHT	0.00
SALES TAX	4.99
TOTAL	\$62.90

CUSTOMER COPY

SONNEN PORSCHE

900 REDWOOD HIGHWAY • MILL VALLEY, CA 94941

Ph: (415) 380-8000

PORSCHE

415-380-8000

INVOICE

BAR # AA 219898

CPA # CA07002369352

CUSTOMER NO. 155006	ADVISOR TRISTAN BAYLESS	TAG NO. 1513 2354	INVOICE DATE 10/08/15	INVOICE NO. POCS394495
	LICENSE NO. 6GDY606	MILEAGE 24,864	COLOR SILVER/	STOCK NO.
	YEAR / MAKE / MODEL 10/PORSCHE/BOXSTER S/BOXSTER S		DELIVERY DATE 12/06/09	DELIVERY MILES
	VEHICLE I.D. NO. W P O C B 2 A 8 9 A U 7 3 0 1 8 3		SELLING DEALER NO.	PRODUCTION DATE
	F.T.E. NO.	P.O. NO.	R.O. DATE 10/08/15	
HOME PHONE	BUSINESS PHONE	COMMENTS		

MO: 24864

JOB# 1 CHARGES-----

LABOR-----

J# 1 99POZZTOW VEHICLE TOWED IN TECH(S):98 INTERNAL
 VEHICLE WAS TOWED IN - INSPECT
 INSPECT VEHICLE

JOB# 1 TOTALS-----

JOB# 2 CHARGES----- JOB# 1 JOURNAL PREFIX POCS JOB# 1 TOTAL 0.00

LABOR-----

J# 2 27POZ CHARGING SYSTEM TECH(S):2064 95.00
 CLIENT STATES ENGINE WOULD NOT CRANK OVER. DASH LIGHTS
 FLASHED AND WIPERS WENT OFF BY THEMSELVES
 TEST BATTERY AND CHARGING SYSTEM.
 IF BATTERY FAILS TESTING, CLIENT HAS AUTHORISED REPLACEMENT
 FOUND BATTERY TO BE WEAK
 REPLACED BATTERY TO CORRECT THE CONCERN

PARTS-----QTY---FP-NUMBER-----DESCRIPTION-----UNIT PRICE-	
1 MTP-48 BATTERY	238.50
TOTAL - PARTS	238.50

MISC-----CODE-----DESCRIPTION-----CONTROL NO-----	
P-DCP15 PORSCHE 15% DISCOUNT COUP PARTS	-35.78
TOTAL - MISC	-35.78

JOB# 2 TOTALS-----

LABOR	95.00
PARTS	238.50
MISC	-35.78

JOB# 2 JOURNAL PREFIX POCS JOB# 2 TOTAL 297.72

ESTIMATE-----

CUSTOMER HEREBY ACKNOWLEDGES RECEIVING ORIGINAL ESTIMATE OF \$315.00 (+TAX)

COMMENTS-----

TOWED IN

THANK YOU

SONNEN PORSCHE

900 REDWOOD HIGHWAY • MILL VALLEY, CA 94941

Ph: (415) 380-8000

PORSCHE

415-380-8000

INVOICE

BAR # AA 219898

CPA# C707002369352

CUSTOMER NO. 155006	ADVISOR TRISTAN BAYLESS	TAG NO. 1513 2354	INVOICE DATE 10/08/15	INVOICE NO. POCS394495
[REDACTED]	LICENSE NO. 6GDY606	MILEAGE 24,864	COLOR SILVER/	STOCK NO.
SONOMA, CA 95476	YEAR / MAKE / MODEL 10/PORSCHE/BOXSTER S/BOXSTER S	DELIVERY DATE 12/06/09	DELIVERY MILES	PRODUCTION DATE
[REDACTED]	VEHICLE I.D. NO. W P O C B 2 A 8 9 A U 7 3 0 1 8 3	SELLING DEALER NO.	R.O. DATE 10/08/15	
[REDACTED]	F.T.E. NO.	P.O. NO.	COMMENTS	

MO: 24864

TOTALS-----

*****	TOTAL LABOR....	95.00
* [] CASH [] CHECK CK NO. [] *	TOTAL PARTS....	238.50
* [] VISA [] MASTERCARD *	TOTAL SUBLET...	0.00
* [] OTHER [] CHARGE *	TOTAL G.O.G....	0.00
*****	TOTAL MISC CHG.	0.00
	TOTAL MISC DISC	-35.78
	TOTAL TAX.....	20.27
	TOTAL INVOICE \$	317.99

CUSTOMER SIGNATURE _____

THANK YOU

INVOICE

Invoice #: **41391**
 Tag #: **T1956**

PORSCHE OF MONTEREY #184
 1781 DEL MONTE BLVD.
 SEASIDE, CA 93955
 PHONE: (831) 899-8888
 FAX: (831) 583-6262
 EPA # CAL000314156 BAR # ARD00247143

Customer #: **116941**
 Contact: **707-938-8328**

SONOMA, CA 95476-7671
 Home Cell: 7

Home Service Advisor: **92520 JOHN FRITZ**

COLOR	YEAR	MAKE/MODEL	VIN	LICENSE	MILEAGE IN	MILEAGE OUT
SIL/Silver	10	PORSCHE BOXSTER	WP0CB2A89AU730183		24056	24056
DEL DATE	PROD. DATE	WARR. EXP.	PROMISED	PO NO.	RATE	PAYMENT
06DEC09	01JAN2010	18:00	22JUL15		0.00	CASH
INV. DATE	R.O. OPENED					
22JUL15	22JUL15	22JUL15				

OPTIONS: SOLID-STK:AU730183PC ENG:3:4

porscheofmontereycares.com
[877] 896-9147

We Sell Tires



Does Your Porsche Need A Spa Day?

Call To Set Up Your Appointment Today!

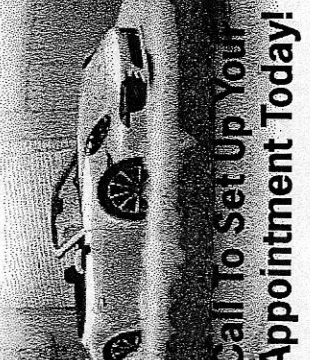

LINE OPCODE TECH TYPE HOURS
 A MOUNT AND BALANCE 4 TIRES
 MB4 MOUNT AND BALANCE 4 TIRES
 96465 CPR
 2 01966 235/40R18 MIC SUPER SPORT
 2 05512 265/40R18 MIC SUPER SPORT
 4 TIRE-TAX TIRE TAX
 4 TD TIRE DISPOSAL
 4 61405 23MM WEIGHT
 PARTS: 1011.82 LABOR: 160.00 OTHER: 0.00 TOTAL LINE A:
 24056
 MOUNTED AND BALANCED 4 TYRES . TYRE PRESSURE SET TO MANUFACTURER
 SPECIFICATION.
 45 MONTHS REMAINING ON THE TYRE PRESSURE SENSORS.
 B PERFORM COURTESY VEHICLE INSPECTION. INCLUDES: VISUAL INSPECTION OF
 VEHICLE, TIRE TREAD DEPTH, AND SET TIRE PRESSURE TO
 SPEC'S (LF RF LR RR)
 VI PERFORM COURTESY VEHICLE INSPECTION. INCLUDES:
 VISUAL INSPECTION OF VEHICLE, TIRE TREAD
 DEPTH AND SET TIRE PRESSURE TO
 SPEC'S (LF RF LR RR)
 96465 IPM 0.00 LABOR: 0.00 OTHER: 0.00 TOTAL LINE B:
 24056 TYRE PRESSURES SET TO 30 PSI FRONT AND 31 PSI REAR. FOR
 ADDITIONAL INFORMATION PLEASE SEE ATTACHED VEHICLE INSPECTION SHEET.

 YOU MAY RECEIVE A SATISFACTION SURVEY BY
 PHONE OR MAIL. IF YOU'RE UNABLE TO ANSWER
 COMPLETELY SATISFIED TO ALL THE QUESTIONS,
 PLEASE CONTACT OUR SERVICE MANAGER. YOUR
 SATISFACTION IS OUR #1 GOAL! THANK YOU FOR
 COMING TO LITHIA PORSCHE OF SEASIDE!
 BAR-AC247143 EPA # CAL000314156

LIST	NET	TOTAL
160.00	160.00	160.00
226.92	200.50	401.00
320.08	291.11	582.22
1.75	1.75	7.00
3.00	2.75	11.00
2.65	2.65	10.60
TOTAL LINE A:		1171.82

(N/C)
 0.00

PAID
 JUL 22 2010

<input type="checkbox"/> Tire pressure check/inflation service was performed.		<input type="checkbox"/> Hazardous waste disposal costs: We have added this charge to cover costs associated with the handling, management and disposal of toxic wastes or hazardous substances under California and Federal law.		LABOR AMOUNT	160.00
<input type="checkbox"/> Customer declined tire pressure check/inflation service.		By signing below, you acknowledge that you were notified of and authorized the Dealership to perform the services/repairs itemized in this invoice and that you received (or had the opportunity to inspect) any replaced parts as requested by you.		PARTS AMOUNT	1011.82
Original Estimate (Parts & Labor)	\$	Approved By:	_____ Initials	GAS, OIL, LUBE	0.00
Revised Estimate	\$	Date & Time	_____ Date & Time	SUBLET AMOUNT	0.00
DATE	_____	CUSTOMER SIGNATURE	_____	WASTE DISPOSAL COSTS*	0.00
		AUTHORIZED DEALERSHIP REPRESENTATIVE SIGNATURE	_____	TOTAL	1171.82
				LESS INS/DED/DIS	0.00
				SALES TAX	87.27
				PLEASE PAY THIS AMOUNT	1259.09

ALL PARTS ARE NEW UNLESS OTHERWISE INDICATED.
 If our Dealership does not have to return the parts to the manufacturer or distributor under a warranty arrangement and they are not exempt due to their size, weight or other factors, they will be returned to you upon request. If you choose to save replaced parts, please note that a core charge may apply.

Some Parts Not Returnable

ARBITRATION AGREEMENT
 Any dispute between you and the dealership arising from or related to this vehicle transaction will be settled by mandatory binding arbitration pursuant to the Federal Arbitration Act 9 U.S.C. § 1 et. seq. The arbitration shall be conducted by a single arbitrator. The arbitrator may grant whatever relief the parties shall be entitled to at law or in equity.

NOTICE TO CONSUMER: PLEASE READ IMPORTANT INFORMATION ON BACK.

THANK YOU!



PORSCHE OF MONTEREY #184

1781 DEL MONTE BLVD.
SEASIDE, CA 93955
PHONE: (831) 899-8888
FAX: (831) 583-6262

22JUL15

Assured Service Repair Order Invoice Letter:

Thank you for your business! At Lithia Porsche of Monterey we strive for your complete satisfaction.

If you have any questions or are not completely satisfied with our service, please let us know immediately. It is the goal of our factory-trained technicians to provide the best work at the most competitive price.

In the coming days, you'll be receiving a manufacturer's survey. This survey may come as an email, a phone call, or a letter. Our manufacturer's are also committed to your satisfaction and grade our business based on your feedback. When our customers are completely satisfied, our manufacturers take notice.

It is our intention for you to score us "Completely Satisfied", as it allows us to maintain a perfect grade. If, for any reason, your experience leaves you feeling short of this, please contact us immediately. We'll take the necessary steps to ensure you are!

Again, we appreciate your continued business and our ongoing relationship.

All the best,

Lithia Porsche of Monterey

BMW PORSCHE OF SEASIDE
1 GEARY PLZ
SEASIDE, CA 93955
831-899-5555

CASEABMWCC3
0017340008010038027022

Date: 07/22/2015 04:51:39 PM

CREDIT CARD SALE

CARD NUMBER: [REDACTED]
TRAN AMOUNT: \$1,259.09
APPROVAL CD: 067950
RECORD #: 000
CLERK ID: db164371
SALES TAX: \$87.27
Description: 41391

Customer Copy

WORKORDER

RO #: 41391

Tag #: T1956

Customer #: 116941

Contact 707-938-8328

SONOMA, CA 95476-7671

Home: [Redacted] Bus:

Cell: [Redacted]

PORSCHE OF MONTEREY #184

1781 DEL MONTE BLVD.
SEASIDE, CA 93955
PHONE: (831) 899-8888
FAX: (831) 583-6262



PORSCHE

Service Advisor: 92520 FRITZ, JOHN

COLOR	YEAR	MAKE/MODEL	VIN	LICENSE	MILEAGE IN	MILEAGE OUT
SIL/Silver	10	PORSCHE BOXSTER	WPOCB2A89AU730183		24056	
DEL. DATE	PROD. DATE	WARR. EXP.	PROMISED	PO. NO.	R.O. OPENED	READY
06DEC09 IS	01JAN2010	18:00	22JUL15		22JUL2015 10:34	

OPTIONS: SOLD-STK:AU730183PC ENG:3:4

**ASSURED SERVICE
RIGHT NOW SERVICE**

QUALITY SERVICE WHEN YOU NEED IT.
THE WAY YOU WANT IT.

UP FRONT PRICING

THE PRICE YOU'RE QUOTED IS THE
PRICE YOU'LL PAY... PERIOD

**3 YEAR/50K MILE
REPAIR WARRANTY**

IF IT BREAKS, WE FIX IT... FREE

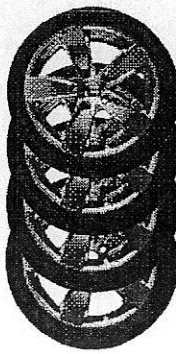

WE SELL TIRES

WITH EVERY TIRE PURCHASE
YOU RECEIVE:

- FREE TIRE REPLACEMENT
- FREE TIRE ROTATION
- FREE FLAT REPAIRS

**HOW'S OUR
DRIVING ?**

PORSCHEOFMONTEREYCAR.COM

[877] 896-9147

LINE OP CODE TECH... TYPE DESCRIPTIONS/INSTRUCTIONS
A MB4 CPR MOUNT AND BALANCE 4 TIRES

IPM PERFORM COURTESY VEHICLE INSPECTION. INCLUDES:
VISUAL INSPECTION OF VEHICLE TIRE TREAD DEPTH, AND
SET TIRE PRESSURE TO SPECS (LF RR).
RR

BAR-AC247143
EPA-# CAL000314156

PORSCHE

ALL PARTS REMOVED WILL BE DISCARDED UNLESS OTHERWISE REQUESTED PRIOR TO BEGINNING WORK. I REQUEST THAT PARTS BE SAVED.

SAVE PARTS X

ORIGINAL ESTIMATE	AUTHORIZED BY	TEARDOWN ESTIMATE: I UNDERSTAND THAT MY VEHICLE WILL BE REASSEMBLED WITHIN _____ DAYS OF THE DATE SHOWN IF I CHOOSE NOT TO AUTHORIZE THE SERVICES RECOMMENDED.
PHONE	DATE	TIME
REVISED ESTIMATE	REASON	ADDITIONAL COST
AUTHORIZED BY	DATE	TIME
	<input type="checkbox"/> IN PERSON <input type="checkbox"/> PHONE #	

WHICH INCLUDES A HAZARDOUS WASTE DISPOSAL FEE OF \$

PRELIMINARY ESTIMATE \$ 1300

THIS IS NOT AN INVOICE

BY LAW, YOU MAY CHOOSE ANOTHER LICENSED SMOG CHECK FACILITY TO PERFORM ANY NEEDED REPAIRS OR ADJUSTMENTS WHICH THE SMOG CHECK TEST INDICATES ARE NECESSARY. SUBJECT TO CONDITIONS ON REVERSE SIDE OF THIS CONTRACT. PLEASE READ REVERSE SIDE.

In the course of servicing, OE equivalent parts may be used. I hereby authorize the repair work herein set forth to be done with the necessary material and agree that you are not responsible for any delays caused by unavailability of parts or delays in parts shipments by the supplier or transporter. I hereby grant you and/or your employees permission to operate the express mechanic's lien in hereby acknowledged for the purpose of testing and/or inspection. A receipt of the vehicle described herein for repair or alteration is hereby acknowledged by dealer. Said customer is hereby notified that the said property is not insured or protected to the amount of actual cash value thereof, or otherwise, by the undersigned dealer against loss occasioned by theft, fire or vandalism while the property remains with the dealer. Customer states no articles of personal property have been left in the vehicle, and the dealer is not responsible for inspection, theft, or collection. Customer will be responsible for payment of reasonable attorney fee and costs in the event suit is brought for collection.

AUTHORIZED BY: X

EPA # CAL000314156 BAR # AC247143

TERMS:

CASH, APPROVED CREDIT CARDS OR CAR CARE ONE CARD UNLESS PRIOR ARRANGEMENTS HAVE BEEN MADE

SONNEN PORSCHE

INVOICE

900 REDWOOD HIGHWAY • MILL VALLEY, CA 94941

Ph: (415) 380-8000

PORSCHE

415-380-8000

BAR # AA 219898

CFA # CAD 20928169352

CUSTOMER NO. 155006	ADVISOR GARY WRIGHT	TAG NO. 1946	INVOICE DATE 02/23/15	INVOICE NO. POCS377994
	LICENSE NO. 6GDY606	MILEAGE 22,753	COLOR SILVER/	STOCK NO.
	YEAR / MAKE / MODEL 10/PORSCHE/BOXSTER S/BOXSTER S		DELIVERY DATE 12/06/09	DELIVERY MILES
SONOMA, CA 95476	VEHICLE I.D. NO. W P O C B 2 A 8 9 A U 7 3 0 1 8 3		SELLING DEALER NO.	PRODUCTION DATE
	F.T.E. NO.	P.O. NO.	R.O. DATE 02/23/15	
NESS PHONE	COMMENTS			

MO: 22754

JOB# 1 CHARGES-----

LABOR-----
 J# 1 03POZ OIL CHNG / GEN MAINT TECH(S):1445 87.57
 OIL AND FILTER CHANGE, CHECK AND SET TIRE PRESSURE, TOP OFF
 FLUID LEVELS
 T100
 --- RESET SERVICE LIGHT ---
 \$199.00
 COMPLETED OIL CHANGE SERVICE

PARTS-----QTY---FP-NUMBER-----DESCRIPTION-----UNIT PRICE-----
 1 PK9A1LOF 9A1 LOF ****
 1 900-123-106-30 ALUM SEAL RING 1.45 1.45
 1 CRC PART WASH 4.95 4.95
 9 040 MOBILE1 OW40 6.99 62.91
 1 996-107-313-51 O-RING 10.00 10.00
 1 9A1-107-224-00 OIL-FILTER INSER 32.12 32.12
 TOTAL - PARTS 111.43

JOB# 1 TOTALS-----
 LABOR 87.57
 PARTS 111.43

JOB# 2 CHARGES----- JOB# 1 JOURNAL PREFIX POCS JOB# 1 TOTAL 199.00

LABOR-----
 J# 2 03POZ002 MULTI-POINT INSPECT TECH(S):1445 INTERNAL
 PERFORM COURTESY INSPECTION AS REQUESTED.CHECK BRAKES, TIRES,
 AND ALL EXTERIOR LIGHTS.CHECK OIL,BRAKE,COOLANT,AND WASHER
 FLUID LEVELS.PLEASE NOTE RESULTS BELOW
 PERFORMED INSPECTIONS AS PER ATTACHED CHECKLIST
 COMPLETED MPI

JOB# 2 TOTALS-----

JOB# 3 CHARGES----- JOB# 2 JOURNAL PREFIX POCS JOB# 2 TOTAL 0.00

LABOR-----
 J# 3 91POZPCM PCM ISSUE TECH(S):1445 INTERNAL
 CUSTOMER STATES THE RADIO STATION MEMORY SETTINGS DO NOT
 STAY IN THE SAME LOCATION ON THE PCM.
 UPDATE PCM SOFTWARE

JOB# 3 TOTALS-----

JOB# 4 CHARGES----- JOB# 3 JOURNAL PREFIX POCS JOB# 3 TOTAL 0.00

LABOR-----
 J# 4 91POZ ENTERTAINMENT SYSTEM TECH(S):1445 INTERNAL
 CUSTOMER STATES NAVIGATION WILL NOT ACCEPT PRE PROGRAMMED
 LOCATION.

THANK YOU

SONNEN PORSCHE

900 REDWOOD HIGHWAY • MILL VALLEY, CA 94941

Ph: (415) 380-8000

PORSCHE

415-380-8000

INVOICE

BAR # AA 219898

CUSTOMER NO. 155006	ADVISOR GARY WRIGHT	TAG NO. 1946	INVOICE DATE 02/23/15	INVOICE NO. POCS377994
	LICENSE NO. 6GDY606	MILEAGE 22,753	COLOR SILVER/	STOCK NO.
	YEAR / MAKE / MODEL 10/PORSCHE/BOXSTER S/BOXSTER S		DELIVERY DATE 12/06/09	DELIVERY MILES
RESIDENCE PHONE SONOMA, CA 95476	VEHICLE I.D. NO. W P O C B 2 A 8 9 A U 7 3 0 1 8 3		SELLING DEALER NO.	PRODUCTION DATE
BUSINESS PHONE	F.T.E. NO.	P.O. NO.	R.O. DATE 02/23/15	
COMMENTS UPDATE PCM SOFTWARE.			MO: 22754	

JOB# 4 TOTALS-----

JOB# 4 JOURNAL PREFIX POCS JOB# 4 TOTAL 0.00

ESTIMATE-----

CUSTOMER HEREBY ACKNOWLEDGES RECEIVING ORIGINAL ESTIMATE OF \$210.00 (+TAX)

COMMENTS-----

TOTALS-----

*
* [] CASH [] CHECK CK NO. [] *
* [] VISA [] MASTERCARD *
* [] OTHER [] CHARGE *
*

TOTAL LABOR.... 87.57
TOTAL PARTS.... 111.43
TOTAL SUBLET... 0.00
TOTAL G.O.G.... 0.00
TOTAL MISC CHG. 0.00
TOTAL MISC DISC 0.00
TOTAL TAX..... 9.47

TOTAL INVOICE \$ 208.47

CUSTOMER SIGNATURE

THANK YOU



PORSCHE

The Porsche Multi-Point Inspection Report

The Porsche Multi-Point Inspection Report is a series of thorough vehicle "health checks" performed by factory-trained Porsche technicians. It is designed to keep your Porsche operating in top condition and to minimize your chances of being inconvenienced on the road. If additional service is recommended on any listed item, your Porsche Service Advisor will be happy to speak with you about your options.

Customer Name _____ Year/Model _____ Engine Size _____

RO/ Tag _____ Mileage _____ VIN _____ Date _____

Checked and Okay at this Time **May Require Future Attention** **Requires Immediate Attention**

Check Fluid Levels and Fill

- | | | | |
|--|--|--|----------------------------|
| OK FILL | | OK FILL | |
| <input checked="" type="checkbox"/> <input type="checkbox"/> | Engine Oil | <input checked="" type="checkbox"/> <input type="checkbox"/> | Brake Reservoir |
| <input checked="" type="checkbox"/> <input type="checkbox"/> | Windshield Washer | <input checked="" type="checkbox"/> <input type="checkbox"/> | Headlamp Washer |
| <input type="checkbox"/> <input type="checkbox"/> | Power Steering | <input checked="" type="checkbox"/> <input type="checkbox"/> | Coolant Recovery Reservoir |
| <input checked="" type="checkbox"/> <input type="checkbox"/> | Transmission (if equipped w/ dipstick) | | |

Check Following Systems / Components

- Operation of horn, interior lights, exterior lamps, turn signals, hazard and brake lamps
- Visually inspect headlamp alignment
- Windshield washer spray, wiper operation and wiper blades
- Windshield cracks and/or chips
- Heating, ventilation and air conditioning check
- Engine air cleaner filter
- Oil and/or fluid leaks
- Constant velocity (CV) drive axle boots (if equipped)
- Exhaust system (leaks, damage, loose parts)
- Steering and steering linkages
- Shocks/struts, air suspension and other suspension components for leaks and/or damage
- Brake system (including lines, hoses and parking brake)
- Engine cooling system, hoses and clamps
- Radiator, heater and air conditioning hoses for leaks / damage
- Accessory drive belt(s)
- Clutch operation (if equipped)
- State inspection due (if applicable) _____ / _____ / _____
Month Day Year
- Your last completed maintenance _____ Mileage ; _____ / _____
Month Year
- Your next factory scheduled maintenance is due at _____ Mileage ; _____ / _____
Month Year

Comments: _____

Check Battery Condition

- Good
- Recharge
- Bad

Comments: _____

Check Brakes

Measure Front / Rear Brake Linings

- RF RR

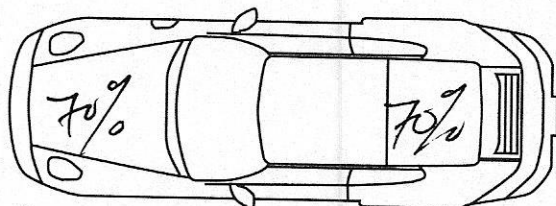

- LF LR

- Over 5mm or 7/32"
- 3 to 5mm or 4/32" to 7/32"
- Less than 3mm or 4/32"
- Brake Measurements Not Taken This Service Visit

Comments: _____

Check Tires

- TREAD DEPTH
- | | | |
|---|------------------|---|
| LF | | RF |
| <input type="checkbox"/> <input type="checkbox"/> <input type="checkbox"/> | 7/32" or Greater | <input type="checkbox"/> <input type="checkbox"/> <input type="checkbox"/> |
| <input checked="" type="checkbox"/> <input type="checkbox"/> <input type="checkbox"/> | 4/32" to 6/32" | <input type="checkbox"/> <input type="checkbox"/> <input type="checkbox"/> |
| <input type="checkbox"/> <input type="checkbox"/> <input type="checkbox"/> | 3/32" or Less | <input type="checkbox"/> <input type="checkbox"/> <input type="checkbox"/> |
| <input type="checkbox"/> <input type="checkbox"/> <input type="checkbox"/> | 7/32" or Greater | <input type="checkbox"/> <input type="checkbox"/> <input type="checkbox"/> |
| <input checked="" type="checkbox"/> <input type="checkbox"/> <input type="checkbox"/> | 4/32" to 6/32" | <input checked="" type="checkbox"/> <input type="checkbox"/> <input type="checkbox"/> |
| <input type="checkbox"/> <input type="checkbox"/> <input type="checkbox"/> | 3/32" or Less | <input type="checkbox"/> <input type="checkbox"/> <input type="checkbox"/> |
| LR | | RR |



- LF Wear Pattern / Damage RF
- LR Tire Wear Indicators RR
- Alignment Check Recommended Wheel Balance Recommended

Comments: _____

This Courtesy Inspection Completed By Your Porsche Service Team

Service Advisor: GARY WRIGHT

Technician: ZANDY GADIANA

Customer Signature: _____

Tire Pressure Set to _____ PSI 30 Front 33 Rear

SONNEN PORSCHE

900 REDWOOD HIGHWAY • MILL VALLEY, CA 94941

Ph: (415) 380-8000

WORK ORDER



PORSCHE

BAR# ARD219898
EPA# CAL00023433

RECOMMENDED SERVICES

OPERATION	OPERATION DESCRIPTION	MO/MI	TOTAL	OPERATION	OPERATION DESCRIPTION	MO/MI	TOTAL

SERVICE HISTORY

DATE	REPAIR ORDER	MILEAGE	ADVISOR	TECHNICIAN	TYPE	OPERATION	OPERATION DESCRIPTION
01/24/14	352014	18696	942	1417	C	03POZ	OIL CHNG / GEN MAINT
				1417	I	03POZ002	MULTI-POINT INSPECT
				1417	C	46POZZ02	BRAKE FLUID SERVICE
				1417	I	61POZZ	CONVERTIBLE TOP
				1417	I	99POZZLOANER	PORSCHE LOANER

SALESPERSON NO.

S E R V I C E

STATE REG# AG133681

VEHICLE ID NO. WP0CB2A89AU730183	YEAR/MAKE/MODEL 10/PORSCHE/BOXSTER S/BOXSTER S	PRODUCTION DATE 12/06/09	STOCK NO.	LICENSE NO. 6GDY606	R. O. NO. 377994
CUSTOMER NO. 155006	SERVICE CONTRACT	DELIVERY DATE 12/06/09	DELIVERY MILES	SELLING DEALER NO.	R. O. DATE 02/23/15
ADDRESS SONOMA, CA 95476		COLOR SILVER/	CONTRACT NO.	EXPIRATION DATE	EXPIRATION MILES
TURBO N	M/MC POZZ	AIR COND. Y	P. S. Y	TRANS	MILEAGE 22,753
BUSINESS PHONE		ADVISOR NO. 942	ADVISOR GARY WRIGHT	TAG NO. 1946	

REPAIR AUTHORIZATION & VEHICLE DEPOSITARY RECEIPT (AB 409 amending civil code)
I hereby authorize the repair work to be done along with the necessary materials. You and your employees may operate vehicle for purpose of testing, inspection or delivery at my risk. An express mechanic's lien is acknowledged on vehicle to secure the amount of repairs thereto. In the event legal action is necessary to enforce this contract, I will pay reasonable attorney's fees and court costs. I acknowledge this deposited property is not insured or protected to the amount of actual cash value thereof by the dealer against loss occasioned by theft, fire and vandalism while such property remains with the depository. I also acknowledge no articles of personal property remains with the depository. I also acknowledge no articles of personal property have been left in vehicle and the dealer is not responsible for the inspection therefor.

APPOINTMENT: Yes No
MILEAGE OUT: **10:19am** DATE/TIME PROMISED: **02/23/15 12:00pm** PRIORITY: **20**
CELL: 707-529-9352

X SAVE PARTS

ORIGINAL CUSTOMER ESTIMATE: TOTAL 210.00

X

COMMENTS:

1 **C 03POZ OIL CHNG / GEN MAINT**
OIL AND FILTER CHANGE, CHECK AND SET TIRE PRESSURE, TOP OFF FLUID LEVELS
T100
--- RESET SERVICE LIGHT ---
\$199.00

2 **I 03POZ002 MULTI-POINT INSPECT**
PERFORM COURTESY INSPECTION AS REQUESTED. CHECK BRAKES, TIRES, AND ALL EXTERIOR LIGHTS. CHECK OIL, BRAKE, COOLANT, AND WASHER FLUID LEVELS. PLEASE NOTE RESULTS BELOW

3 **W 91POZPCM PCM ISSUE**
CUSTOMER STATES THE RADIO STATION MEMORY SETTINGS DO NOT STAY IN THE SAME LOCATION ON THE PCM.

ORIGINAL ESTIMATE X HAZARDOUS WASTE REMOVAL EST. \$

TEARDOWN ESTIMATE
I understand that my vehicle will be reassembled within _____ days of the date shown above if I choose not to authorize the services recommended.

1ST REV. EST. ADD. COST AUTHORIZED BY:

DATE TIME PHONE CONTACTED BY:
 IN PERSON BY FAX
 BY PHONE BY EMAIL

REVISION DETAILS:

1ST REV. EST. ADD. COST AUTHORIZED BY:

DATE TIME PHONE CONTACTED BY:
 IN PERSON BY FAX
 BY PHONE BY EMAIL

I acknowledge notice and oral approval of an increase in the original estimate

X CUSTOMER SIGNATURE
I hereby designate the individual named below to authorize any additional work not specified or parts not included in the original written estimated price for parts and labor

Name of Designee: Phone Number:
E-Mail Address: Fax Number:

Customer's Signature Date

X

BY LAW, YOU MAY CHOOSE ANOTHER FACILITY TO PERFORM ANY NEEDED REPAIRS OR ADJUSTMENTS WHICH THE SMOG CHECK TEST INDICATES ARE NECESSARY

ALL PARTS REMOVED WILL BE DISCARDED UNLESS OTHERWISE REQUESTED PRIOR TO BEGINNING WORK.

ALL PARTS ARE NEW OR FACTORY REMANUFACTURED UNLESS OTHERWISE SPECIFIED.

SONNEN PORSCHE

900 REDWOOD HIGHWAY • MILL VALLEY, CA 94941

Ph: (415) 380-8000

WORK ORDER

2007
Premier
Porsche Dealer

PORSCHE

BAR# ARD219898
EPA# CAL00023433

RECOMMENDED SERVICES

OPERATION	OPERATION DESCRIPTION	MO/MI	TOTAL	OPERATION	OPERATION DESCRIPTION	MO/MI	TOTAL

SERVICE HISTORY

DATE	REPAIR ORDER	MILEAGE	ADVISOR	TECHNICIAN	TYPE	OPERATION	OPERATION DESCRIPTION
01/24/14	352014	18696	942	1417	C	03POZ	OIL CHNG / GEN MAINT
				1417	I	03POZ002	MULTI-POINT INSPECT
				1417	C	46POZZ02	BRAKE FLUID SERVICE
				1417	I	61POZZ	CONVERTIBLE TOP
				1417	I	99POZZLOANER	PORSCHE LOANER

SALESPERSON NO.

S E R V I C E

STATE REG# AG133681

VEHICLE ID NO. WP0CB2A89AU730183	YEAR/MAKE/MODEL 10/PORSCHE/BOXSTER S/BOXSTER S	PRODUCTION DATE 12/06/09	STOCK NO.	LICENSE NO. 6GDY606	R. O. NO. 377994
CUSTOMER NO. 155006	SERVICE CONTRACT	DELIVERY DATE	DELIVERY MILES	SELLING DEALER NO.	R. O. DATE 02/23/15
COLOR SILVER/	CONTRACT NO.	EXPIRATION DATE	EXPIRATION MILES	TAG NO. 1946	
TURBO N	M/MC POZZ	AIR COND. Y	P. S. Y	TRANS	MILEAGE 22,753
RESIDENCE PHONE	BUSINESS PHONE	ADVISOR NO. 942	ADVISOR GARY WRIGHT		

REPAIR AUTHORIZATION & VEHICLE DEPOSITARY RECEIPT (AB 409 amending civil code)
I hereby authorize the repair work to be done along with the necessary materials. You and your employees may operate vehicle for purpose of testing, inspection or delivery at my risk. An express mechanic's lien is acknowledged on vehicle to secure the amount of repairs thereto. In the event legal action is necessary to enforce this contract, I will pay reasonable attorney's fees and court costs. I acknowledge this deposited property is not insured or protected to the amount of actual cash value thereof by the dealer against loss occasioned by theft, fire and vandalism while such property remains with the depository. I also acknowledge no articles of personal property remains with the depository. I also acknowledge no articles of personal property have been left in vehicle and the dealer is not responsible for the inspection therefor.

APPOINTMENT
 Yes
 No

MILEAGE OUT
10:19am **02/23/15** **12:00pm** **20**

CELL: 707-529-9352

X SAVE PARTS

JOB

4 **W 91POZ ENTERTAINMENT SYSTEM**
CUSTOMER STATES NAVIGATION WILL NOT ACCEPT PRE PROGRAMMED LOCATION.

ORIGINAL ESTIMATE <input checked="" type="checkbox"/> X	HAZARDOUS WASTE REMOVAL EST. \$
TEARDOWN ESTIMATE	
I understand that my vehicle will be reassembled within _____ days of the date shown above if I choose not to authorize the services recommended.	
1ST REV. EST.	AUTHORIZED BY:
DATE	TIME
PHONE	CONTACTED BY:
	<input type="checkbox"/> IN PERSON <input type="checkbox"/> BY FAX
	<input type="checkbox"/> BY PHONE <input type="checkbox"/> BY EMAIL
REVISION DETAILS:	
1ST REV. EST.	AUTHORIZED BY:
DATE	TIME
PHONE	CONTACTED BY:
	<input type="checkbox"/> IN PERSON <input type="checkbox"/> BY FAX
	<input type="checkbox"/> BY PHONE <input type="checkbox"/> BY EMAIL
REVISION DETAILS:	
I acknowledge notice and oral approval of an increase in the original estimate	
X _____	
CUSTOMER SIGNATURE	
I hereby designate the individual named below to authorize any additional work not specified or parts not included in the original written estimated price for parts and labor	
Name of Designee:	Phone Number:
E-Mail Address:	Fax Number:
Customer's Signature	Date
X _____	
BY LAW, YOU MAY CHOOSE ANOTHER FACILITY TO PERFORM ANY NEEDED REPAIRS OR ADJUSTMENTS WHICH THE SMOG CHECK TEST INDICATES ARE NECESSARY	
ALL PARTS REMOVED WILL BE DISCARDED UNLESS OTHERWISE REQUESTED PRIOR TO BEGINNING WORK.	
ALL PARTS ARE NEW OR FACTORY REMANUFACTURED UNLESS OTHERWISE SPECIFIED.	

SONNEN PORSCHE

740 FRANCISCO BLVD. WEST • SAN RAFAEL, CA 94901

Ph: (415) 380-8000

PORSCHE

415-380-8000

INVOICE

BAR # AA 219898

CPA # CA070028169352

CUSTOMER NO. 155006	ADVISOR GARY WRIGHT	TAG NO. 942 2669	INVOICE DATE 01/24/14	INVOICE NO. POCS352014
	LICENSE NO. 6GDY606	MILEAGE 18,696	COLOR SILVER/	STOCK NO.
SONOMA, CA 95476	YEAR / MAKE / MODEL 10/PORSCHE/BOXSTER S/BOXSTER S	DELIVERY DATE 12/06/09	DELIVERY MILES	
	VEHICLE I.D. NO. W P O C B 2 A 8 9 A U 7 3 0 1 8 3	SELLING DEALER NO.	PRODUCTION DATE	
	F.T.E. NO.	P.O. NO.	R.O. DATE 01/24/14	
	SS PHONE	COMMENTS		

MO: 18697

JOB# 1 CHARGES-----

LABOR-----
 J# 1 03POZ OIL CHNG / GEN MAINT TECH(S):1417 140.47
 OIL AND FILTER CHANGE, CHECK AND SET TIRE PRESSURE, TOP OFF
 FLUID LEVELS
 T100
 --- RESET SERVICE LIGHT ---
 \$199.00 SPECIAL
 PERFORMED LOF RESET SERVICE LIGHT.

PARTS-----QTY---FP-NUMBER-----DESCRIPTION-----UNIT PRICE-----
 1 PK9A1LOF 9A1 LOF *****
 1 900-123-106-30 ALUM SEAL RING 1.46 1.46
 1 CRC PART WASH 4.95 4.95
 9 040 MOBILE1 0W40 6.99 62.91
 1 996-107-313-51 O-RING 9.29 9.29
 1 9A1-107-224-00 OIL-FILTER INSER 29.92 29.92
 TOTAL - PARTS 108.53

MISC-----CODE-----DESCRIPTION-----CONTROL NO-----
 P-WOF PORSCHE HAZ WASTE/OIL & FILTER 4.50
 P-DP DISCOUNT PARTS -25.00
 P-DL PORSCHE DISCOUNT LABOR COUPON -25.00
 TOTAL - MISC -45.50

JOB# 1 TOTALS-----

LABOR 140.47
 PARTS 108.53
 MISC -45.50

JOB# 2 CHARGES----- JOB# 1 JOURNAL PREFIX POCs JOB# 1 TOTAL 203.50

LABOR-----
 J# 2 03POZ002 MULTI-POINT INSPECT TECH(S):1417 INTERNAL
 PERFORM COURTESY INSPECTION AS REQUESTED.CHECK BRAKES, TIRES,
 AND ALL EXTERIOR LIGHTS.CHECK OIL, BRAKE, COOLANT, AND WASHER
 FLUID LEVELS.PLEASE NOTE RESULTS BELOW
 PERFORMED INSPECTIONS AS PER ATTACHED CHECKLIST
 PERFORMED MPI. FRONT PADS 90%, REAR PADS 85%, FRONT TIRES
 4.5MM, REAR TIRES 4MM.

JOB# 2 TOTALS-----

JOB# 3 CHARGES----- JOB# 2 JOURNAL PREFIX POCs JOB# 2 TOTAL 0.00

LABOR-----
 J# 3 46POZZ02 BRAKE FLUID SERVICE TECH(S):1417 175.17
 CUSTOMER REQUESTS A BRAKE SYSTEM FLUSH AND FLUID
 REPLACEMENT.
 T100
 PERFORMED BRAKE FLUID FLUSH PER CUSTOMER REQUEST.

THANK YOU

SONNEN PORSCHE

INVOICE

740 FRANCISCO BLVD. WEST • SAN RAFAEL, CA 94901

Ph: (415) 380-8000

PORSCHE

415-380-8000

BAR # AA 219898
 EPA # CAD0023169352

CUSTOMER NO. 155006	ADVISOR GARY WRIGHT	TAG NO. 942 2669	INVOICE DATE 01/24/14	INVOICE NO. POCS352014
	LICENSE NO. 6GDY606	MILEAGE 18,696	COLOR SILVER/	STOCK NO.
	YEAR / MAKE / MODEL 10/PORSCHE/BOXSTER S/BOXSTER S		DELIVERY DATE 12/06/09	DELIVERY MILES
SONOMA, CA 95476	VEHICLE I.D. NO. W P 0 C B 2 A 8 9 A U 7 3 0 1 8 3		SELLING DEALER NO.	PRODUCTION DATE
	F.T.E. NO.	P.O. NO.	R.O. DATE 01/24/14	
BUSINESS PHONE	COMMENTS			

MO: 18697

PARTS	QTY	FP-NUMBER	DESCRIPTION	UNIT PRICE	PRICE
	1	000-043-203--666	BRAKE FLUID	34.83	34.83
				TOTAL - PARTS	34.83

JOB# 3 TOTALS				LABOR	175.17
				PARTS	34.83

JOB# 4 CHARGES	JOB# 3 JOURNAL PREFIX	POCS	JOB# 3 TOTAL	210.00
----------------	-----------------------	------	--------------	--------

LABOR
 J# 4 61POZZ CONVERTIBLE TOP TECH(S):1417 INTERNAL
 CUSTOMER STATES THERE IS A SNAP NOISE WHEN OPENING
 CONVERTIBLE ROOF.
 LEFT SIDE TOP FLAP BINDING ON FRAME.
 LUBRATED FLAP, RETESTED OKAY AT THIS TIME.

JOB# 4 TOTALS				
---------------	--	--	--	--

JOB# 5 CHARGES	JOB# 4 JOURNAL PREFIX	POCS	JOB# 4 TOTAL	0.00
----------------	-----------------------	------	--------------	------

LABOR
 J# 5 99POZZ LOANER PORSCHE LOANER TECH(S):1417 INTERNAL
 CUSTOMER PROVIDED LOANER VEHICLE.
 91855 VIN#WP0AA2A74EL005362

JOB# 5 TOTALS				
---------------	--	--	--	--

JOB# 5 JOURNAL PREFIX	POCS	JOB# 5 TOTAL	0.00
-----------------------	------	--------------	------

ESTIMATE
 CUSTOMER HEREBY ACKNOWLEDGES RECEIVING
 ORIGINAL ESTIMATE OF \$525.00 (+TAX)

THANK YOU

SONNEN PORSCHE

INVOICE

740 FRANCISCO BLVD. WEST • SAN RAFAEL, CA 94901

Ph: (415) 380-8000

PORSCHE

415-380-8000

BAR # AA 219898

CPA # CA 00028169352

CUSTOMER NO. 155006	ADVISOR GARY WRIGHT	TAG NO. 942 2669	INVOICE DATE 01/24/14	INVOICE NO. POCS352014
	LICENSE NO. 6GDY606	MILEAGE 18,696	COLOR SILVER/	STOCK NO.
	YEAR / MAKE / MODEL 10/PORSCHE/BOXSTER S/BOXSTER S		DELIVERY DATE 12/06/09	DELIVERY MILES
SONOMA, CA 95476	VEHICLE I.D. NO. W P 0 C B 2 A 8 9 A U 7 3 0 1 8 3		SELLING DEALER NO.	PRODUCTION DATE
	F.T.E. NO.	P.O. NO.	R.O. DATE 01/24/14	
PHONE	COMMENTS			

MO: 18697

TOTALS-----

*****	TOTAL LABOR....	315.64
* [] CASH [] CHECK CK NO. [] *	TOTAL PARTS....	143.36
* [] VISA [] MASTERCARD *	TOTAL SUBLET...	0.00
* [] OTHER [] CHARGE *	TOTAL G.O.G....	0.00
*****	TOTAL MISC CHG.	4.50
	TOTAL MISC DISC	-50.00
	TOTAL TAX.....	12.19
	TOTAL INVOICE \$	425.69

CUSTOMER SIGNATURE _____

THANK YOU



PORSCHE

The Porsche Multi-Point Inspection Report

The Porsche Multi-Point Inspection Report is a series of thorough vehicle "health checks" performed by factory-trained Porsche technicians. It is designed to keep your Porsche operating in top condition and to minimize your chances of being inconvenienced on the road. If additional service is recommended on any listed item, your Porsche Service Advisor will be happy to speak with you about your options.

Customer Name: [REDACTED] Year/Model: 2010 BOXSTER Engine Size: 3.4L
 RO/Tag: 352014 Mileage: 18696 VIN: WPOCB2A89AU730183 Date: 1/24/14

Checked and Okay at this Time May Require Future Attention Requires Immediate Attention

Check Fluid Levels and Fill

OK FILL	OK FILL
<input checked="" type="checkbox"/> Engine Oil	<input checked="" type="checkbox"/> Brake Reservoir
<input checked="" type="checkbox"/> Windshield Washer	<input checked="" type="checkbox"/> Headlamp Washer
<input checked="" type="checkbox"/> Power Steering	<input checked="" type="checkbox"/> Coolant Recovery Reservoir
<input checked="" type="checkbox"/> Transmission (if equipped w/ dipstick)	

Check Following Systems / Components

- Operation of horn, interior lights, exterior lamps, turn signals, hazard and brake lamps
- Visually inspect headlamp alignment
- Windshield washer spray, wiper operation and wiper blades
- Windshield cracks and/or chips
- Heating, ventilation and air conditioning check
- Engine air cleaner filter
- Oil and/or fluid leaks
- Constant velocity (CV) drive axle boots (if equipped)
- Exhaust system (leaks, damage, loose parts)
- Steering and steering linkages
- Shocks/struts, air suspension and other suspension components for leaks and/or damage
- Brake system (including lines, hoses and parking brake)
- Engine cooling system, hoses and clamps
- Radiator, heater and air conditioning hoses for leaks / damage
- Accessory drive belt(s)
- Clutch operation (if equipped)
- State inspection due (if applicable) _____ / _____ / _____
Month Day Year
- Your last completed maintenance 18696 Mileage; 1/14 Month Year
- Your next factory scheduled maintenance is due at _____ Mileage; _____ / _____ / _____
Month Year

Comments: _____

Check Battery Condition

Good Recharge Bad
 Comments: _____

Check Brakes

Measure Front / Rear Brake Linings

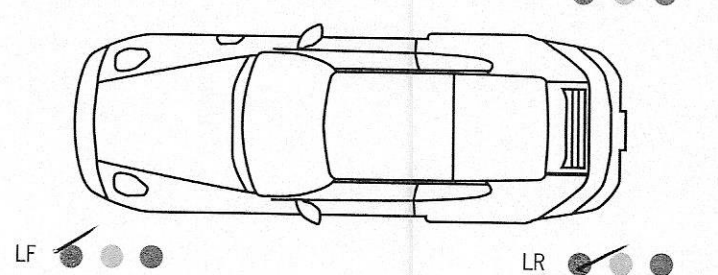

Over 5mm or 7/32"

3 to 5mm or 4/32" to 7/32"

Less than 3mm or 4/32"

Brake Measurements Not Taken This Service Visit

Comments:
FR 90%
RR 85%

Check Tires

LF	TREAD DEPTH	RF
<input checked="" type="checkbox"/> 7/32" or Greater		<input checked="" type="checkbox"/> 7/32" or Greater
<input type="checkbox"/> 4/32" to 6/32"		<input type="checkbox"/> 4/32" to 6/32"
<input type="checkbox"/> 3/32" or Less		<input type="checkbox"/> 3/32" or Less
<input checked="" type="checkbox"/> 7/32" or Greater		<input checked="" type="checkbox"/> 7/32" or Greater
<input type="checkbox"/> 4/32" to 6/32"		<input type="checkbox"/> 4/32" to 6/32"
<input type="checkbox"/> 3/32" or Less		<input type="checkbox"/> 3/32" or Less
LR		RR

LF RF Wear Pattern / Damage

LR RR Tire Wear Indicators

Alignment Check Recommended Wheel Balance Recommended

Comments:
FR - 4.5mm
RR - 4mm

Tire Pressure Set to
 Factory Recommendations PSI 30 Front 31 Rear

This Courtesy Inspection Completed By Your Porsche Service Team

Service Advisor: GARY WRIGHT

Technician: 1417

Customer Signature: _____



PORSCHE

September 4, 2013



Sonoma, CA 95476-7671

Porsche Cars North America, Inc.

980 Hammond Drive
Suite 1000
Atlanta, Georgia 30328
1-800-PORSCHE

Congratulations,

In selecting a Porsche, you have chosen a special and exceedingly rare breed of automobile. One born in the art of hand craftsmanship, with sporting bloodlines as genuine as the exhaust note. Every Porsche we build is a monument to authenticity... and the kind of unflinching performance that transforms the daily driving routine into one of fun, freedom and pure excitement.

I would like to personally thank you for choosing to become a member of the Porsche family of owners. No other carmaker in history has managed to push innovation so far forward while remaining true to the soul of its ancestry. The Porsche in your driveway has been meticulously engineered with one purpose in mind: to fuel a driver's passion for performance, precision and the pure joy of the open road. Your Porsche Approved Certified Pre-owned vehicle has gone through a 111 point mechanical and cosmetic inspection to ensure your purchase meets all the Program's standards.

Porsche Cars North America is proud of the relationship we have with our customers and want to keep you as informed as possible. Upon delivery of your Porsche Approved Certified Pre-Owned vehicle, your selling dealer should have provided you with a Statement of Certification and a Porsche Approved Limited Warranty Booklet along with your Porsche Approved Certified Pre-owned Owner Cards.

To discover the many benefits of Porsche ownership, I encourage you to review the materials enclosed with your Welcome Kit. For more information on all of the unique programs and services available to Porsche owners, please contact your authorized Porsche dealer.

Once again, welcome to the Porsche family and congratulations on your purchase of a very special automobile - one capable of igniting your senses and sense of adventure like nothing else on the road today.

Wishing you a lifetime of rewarding journeys,

Detlev von Platen
President and Chief Executive Officer

VIN:WPOCB2A89AU730183
102906011



PORSCHE OF MONTEREY #184

1781 DEL MONTE BLVD.
SEASIDE, CA 93955
PHONE: (831) 899-8888
FAX: (831) 583-6262

PORSCHE

REMIT PAYMENT TO: LITHIA MOTORS PAYMENT PROCESSING
P.O. BOX 1647 · MEDFORD, OR 97501-0249

POSITIVELY NO EXCHANGES WITHOUT THIS TICKET
NO REFUNDS ON SPECIAL ORDERS
T NO REFUNDS AFTER 30 DAYS
E 20% HANDLING CHARGE ON ALL RETURNED PARTS
R NO RETURNS ON ELECTRICAL PARTS
M REFUND ON PURCHASES PAID BY CHECK ARE
S REFUNDED AFTER CHECK CLEARS
PRICES SUBJECT TO CHANGE WITHOUT NOTICE

DATE ENTERED 19 AUG 13	YOUR ORDER NO.	DATE SHIPPED 19 AUG 13	INVOICE DATE 19 AUG 13	INVOICE NUMBER 14677
---------------------------	----------------	---------------------------	---------------------------	-------------------------

S
O
L
D
T
O

ACCOUNT NO. 99

S
H
I
P
T
O
CASH

PAGE 1 OF 1

SHIP VIA			SLSM.	B/L NO.	TERMS	F.O.B.		
			162382		CASH	SEASIDE, CA		
ORD.	SHIP	B.O.	PART NUMBER	DESCRIPTION	LIST	NET	AMOUNT	
1	1	0	000-044-000-91	080 PRESE	20.18	20.18	20.18	
1	1	0	999-901-068-40	080 LEATH	5.55	5.55	5.55	
1	1	0	000-044-000-03	080 PRESE	20.18	20.18	20.18	

*Top Protector
Leath Clear
Leath Preser*

PAID
AUG 19 2013

If legal action becomes necessary to collect payment for the above parts or any additional parts authorized by the customer, the prevailing party shall be entitled to recover reasonable attorney's fees and costs incurred in such collection action, including any appeal.

Received By _____
STATEMENT OF DISCLAIMER AND ARBITRATION AGREEMENT
The factory warranty constitutes all of the warranties with respect to the sale of this item/items. The Seller hereby expressly disclaims all warranties either express or implied, including any implied warranty of merchantability or fitness for a particular purpose. Seller neither assumes nor authorizes any other person to assume for it any liability in connection with the sale of this item/items. Any dispute between customer and the dealership arising from or related to this vehicle or this transaction will be settled by mandatory and binding arbitration pursuant to the Federal Arbitration Act 9 U.S.C § 1 et. seq. The arbitration shall be conducted by a single arbitrator. The arbitrator may grant whatever relief the parties may be entitled to at law or in equity.

PARTS	45.91
SUBLET	
FREIGHT	0.00
SALES TAX	3.90
TOTAL	\$49.81

Mc

CUSTOMER COPY



PORSCHE OF MONTEREY #184

1781 DEL MONTE BLVD.
SEASIDE, CA 93955
PHONE: (831) 899-8888
FAX: (831) 583-6262

PORSCHE

REMIT PAYMENT TO: LITHIA MOTORS PAYMENT PROCESSING
P.O. BOX 1647 · MEDFORD, OR 97501-0249

POSITIVELY NO EXCHANGES WITHOUT THIS TICKET
NO REFUNDS ON SPECIAL ORDERS
T NO REFUNDS AFTER 30 DAYS
E 20% HANDLING CHARGE ON ALL RETURNED PARTS
R NO RETURNS ON ELECTRICAL PARTS
M REFUND ON PURCHASES PAID BY CHECK ARE
S REFUNDED AFTER CHECK CLEARS
PRICES SUBJECT TO CHANGE WITHOUT NOTICE

DATE ENTERED 19 AUG 13	YOUR ORDER NO.	DATE SHIPPED 21 AUG 13	INVOICE DATE 21 AUG 13	INVOICE NUMBER 14678
---------------------------	----------------	---------------------------	---------------------------	-------------------------

S
O
L
D
T
O

ACCOUNT NO. 99

S
H
I
P
T
O

PAGE 1 OF 1

SONOMA, 95476

SHIP VIA			SLSM.	B/L NO.	TERMS	F.O.B.		
ORD.	SHIP	B.O.	PART NUMBER	DESCRIPTION	LIST	NET	AMOUNT	
1	1	0	997-044-000-04	SP LUGGA	185.63	185.63	185.63	
1	1	0	PNA-505-987	SP UVS S	95.07	63.25	63.25	
1	1	0	FRT	FRT SHP/H	14.33	12.33	12.33	

PAID

AUG 21

PORSCHE OF MONTEREY

mc

If legal action becomes necessary to collect payment for the above parts or any additional parts authorized by the customer, the prevailing party shall be entitled to recover reasonable attorney's fees and costs incurred in such collection action, including any appeal.

X Received By STATEMENT OF DISCLAIMER AND ARBITRATION AGREEMENT

The factory warranty constitutes all of the warranties with respect to the sale of this item/items. The Seller hereby expressly disclaims all warranties either express or implied, including any implied warranty of merchantability or fitness for a particular purpose. Seller neither assumes nor authorizes any other person to assume for it any liability in connection with the sale of this item/items. Any dispute between customer and the dealership arising from or related to this vehicle or this transaction will be settled by mandatory and binding arbitration pursuant to the Federal Arbitration Act 9 U.S.C. § 1 et. seq. The arbitration shall be conducted by a single arbitrator. The arbitrator may grant whatever relief the parties may be entitled to at law or in equity.

PARTS	261.21
SUBLET	
FREIGHT	0.00
SALES TAX	22.20
TOTAL	\$283.41

CUSTOMER COPY

BMW PORSCHE OF SEASIDE
1 GEARY PLZ
SEASIDE, CA 93955
831-899-5555

CASEABMWCC3
0017340008010038027022

Date: 08/21/2013 11:51:52 AM

CREDIT CARD SALE

CARD NUMBER:
TRAN AMOUNT: \$283.41
APPROVAL CD: 02132B
RECORD #: 002
CLERK ID: ed96726
Description: 14678

Customer Copy

Update for PCM MAU



PORSCHE

2010 Boxster S (987)

Vehicle data

Displacement:	3.4 l	Exterior Color:	GT Silver Metallic
Power Output:	228 kW / 310 HP	Interior Color:	Special Leather Cocoa
Transmission:	Automatic	VIN:	WPOCB2A89AU730183
Original In-Service Date:	Dec 6, 2009	Fuel:	Gas
Mileage:	15,514 m	Pre-Owner:	1

Equipment

- 7-speed Porsche Doppelkupplung (PDK)
- Heated Front Seats
- Heated Steering Wheel
- 18" Boxster S II wheel
- Wheel Caps with Colored Crest
- Porsche Windstop (Deflector)
- Automatic Climate Control
- Bluetooth Interface for Mobile Phone
- Bose Surround Sound System
- Floor Mats in Interior Color
- Universal Audio Interface
- Roll Bar Painted in Exterior Color
- Self-Dim Mirrors & Rain Sensor
- Power Seat Package
- PCM 3.0 including Extended Navigation

Porsche Approved Certified Pre-owned Benefits

Porsche Approved Certified Pre-owned Limited Warranty covers up to 6 years, or a cumulative 100,000 Miles from the original in-service date (whichever occurs first), if the vehicle is still under the new car limited warranty at the time of purchase. Comprehensive mechanical and cosmetic inspection completed prior to certification. 24 hour Porsche Roadside Assistance. No deductible for warranty claims.



Vehicle price

\$ 49,981

Statement of Certification

More than 70 % of all Porsches ever built are still on the road today. This record value speaks for itself. That is why **Porsche Approved** is the grade given to pre-owned Porsche vehicles which meet the high quality standards of the Porsche brand. It is the only way to acquire a pre-owned Porsche. The purpose of this document is to confirm that the selling Porsche Dealership has reviewed with you the key points of the **Porsche Approved. Certified Pre-owned Program**

QUALITY

- Your Porsche Approved Certified Pre-owned vehicle has a clean vehicle history report
- Your Porsche Approved Certified Pre-owned Vehicle has been inspected by factory trained technicians who conducted a 111+ point mechanical and cosmetic inspection
- Your Porsche Approved Certified Pre-owned Vehicle has had all repairs and reconditioning carried out in line with the strict quality inspection standards

WARRANTY

- Your Porsche Approved Certified Pre-owned vehicle is covered by one of the following **limited warranty coverages:**
 - Coverage is up to 6 years or a cumulative 100,000 miles/ 160,000 kilometers, whichever comes first from the original in-service date
 CPO Warranty end date: _____
 - For vehicles no longer under the new vehicle limited warranty coverage at the time of used retail delivery, coverage extends until the earlier of: **2 years from the date of used retail delivery OR up to 50,000 miles from mileage at used retail delivery, but not to exceed a cumulative 100,000 total miles on the vehicle**
 CPO Warranty end date: _____
- Porsche Cars N.A. will repair or replace with a new or remanufactured part any factory-installed part that is **faulty in material workmanship** under normal use
- Your Porsche Approved Certified Pre-owned Limited Warranty is honored in the continental United States and Canada
- Your Porsche Approved Certified Pre-owned vehicle also comes with Porsche Assistance, exclusive roadside assistance, for the duration of the warranty coverage
- The limited warranty does not cover:
 - ✓ Wear and tear items
 - ✓ Emission Control Systems and Corrosion
 - ✓ Abuse, accident, acts of nature, problems caused by competitive racing or track use
 - ✓ Scheduled maintenance

SATISFACTION

- A clean car ready for delivery
- A full tank of gas
- Statement of Certification Sticker placed in driver side door jam



Customer Signature

8/17/13

Date

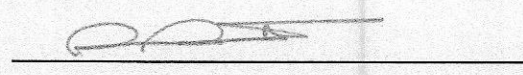

Porsche Sales Professional Signature

A. Vehicle data

Dealer #: 152 Name Porsche / Monterey
 VIN: WUPOCB2A55A4730183 In-Service Date: 10.26.09 (required)
 Mileage: 13,510 Engine #: 402605 Trans #: 1006373

Vehicle Source

Trade Auction Lease Return

Vehicle History Report²

yes no date run _____

Does this vehicle have any aftermarket accessories installed? ¹ yes no

B. Vehicle documentation - Pass or Fail (Check one)

Check PPN Warranty History For:

- pass fail mileage discrepancies
- pass fail open recall campaigns/service actions completed
- pass fail Odometer: check for tampering
- pass fail Glove Box Portfolio, Include:
- pass fail Owner's Manual
- pass fail Warranty Booklet
- pass fail Maintenance Booklet
- pass fail All servicing documented by Porsche dealers
- pass fail Perform Scheduled Maintenance
- pass fail Indicate
- If within 2,500 miles, or
- If last recorded service was > 10 months ago

- pass fail Air Bag System Maintenance:
(per Porsche recommended maintenance)
- pass fail All emission control systems must be functional.
Any item that has been tampered with must be brought into compliance.
- pass fail Check DME control unit: signs of tampering?
- yes no Retrieve and address any faults codes?
1 _____ 2 _____ 3 _____ 4 _____
- Radio/navigation system manual
- Radio code (card) number: _____

- CD changer code (card) number: _____
- Navigation CD/DVD, version: _____
- Number of keys _____
- Vehicle tool kit, jack, compressor, emergency tire kit, first aid kit, wheel anti-theft protection, spare wheel, warning triangle

C. Lights, Switches & Accessories - Pass or Fail (Check one)

- pass fail Ignition/Starter switch
- pass fail Headlights - low beams/high beams
- pass fail Emergency flasher switch
- pass fail Fog/driving lights
- pass fail Stop lights
- pass fail Key light (install new battery)
- pass fail Drive block system remote transmitter
(install new battery for the transmitter)
- pass fail All exterior lights checked for operation
- pass fail All interior lights checked for operation

- pass fail Cigarette lighter
- pass fail Clock (set to correct time)
- pass fail Windshield and rear window wipers (replace all wiper inserts)
- pass fail Windshield and rear window washer system
- pass fail Headlight washers
- pass fail Horn(s)
- pass fail Warning display lights
- pass fail Instrument panel dimming
- pass fail Power window switches
- pass fail Park Assistant

D. Exterior: Underbody, Body, Doors, Lids & Top - Pass or Fail (Check one)

- Is there visible evidence of existing damage to the vehicle? Yes No ⁴
- pass fail Axle joints
 - pass fail Leaks: engine, transmission, differential, transfer case
 - pass fail Gas cap
 - pass fail Wheel locks
 - pass fail Front/rear lid release actuation
 - pass fail Door:
 - pass fail hinges
 - pass fail door closing
 - pass fail door locks
 - pass fail check straps
 - pass fail window lifter mechanisms
 - pass fail Seat adjusters
 - pass fail Sunroof/sliding roof mechanism and locks
 - pass fail Cabriolet top operation
 - pass fail Targa top operation

- pass fail Underbody inspection for damage/corrosion:
- pass fail exhaust system
- pass fail brake lines/hoses
- pass fail fuel lines/hoses
- pass fail Glass - chips or cracks
- pass fail Brake calipers/cylinders, air ducts, cover plates

Does this vehicle have signs of previous collision damage/repairs (vehicle is not eligible if more than 2 body panels painted or signs of frame damage)?

If yes, this vehicle may not be eligible for certification. Consult the Porsche Approved Policy & Procedure Manual for clarification.

Note: Paint touch-ups for rock chips and parking lot dings are not considered collision damage.

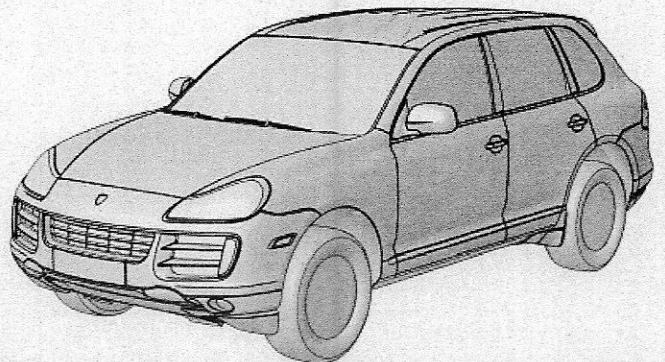
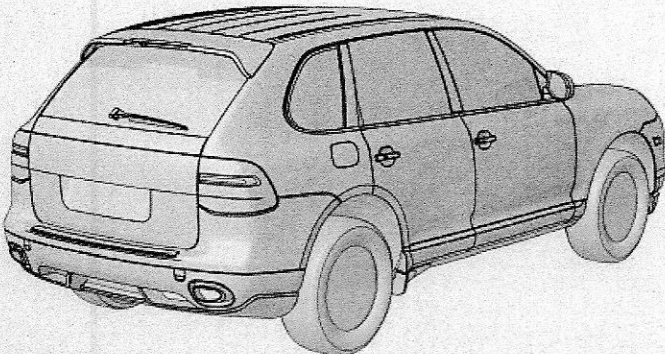

¹ Any aftermarket or non-Porsche accessories, disqualifies this vehicle for eligibility to the Porsche Approved CPO Program.

² A Vehicle History Report is required as a part of this inspection.

³ **Pass** = Component or system meets Porsche guidelines and standards.

Fail = Does not meet Porsche guidelines and standards. Repair or replacement of component or system is required.

⁴ Any dings or scratches on the vehicle should be denoted on the Cayenne image.

E. Tires / Brakes

- pass fail Tread depth (min. 4 mm)
- pass fail Tire size:
- pass fail Tire pressures
- pass fail Tire pressure monitor

Measuring points (in mm)	Inside	Center	Outside
Front left	5	5	5
Rear left	4	4	4
Rear right	4	4	4
Front right	5	5	5
Spare wheel			

NOTE: ALL four tires must be of the same brand, model, speed rating and, specification code. If tread depth is less than four (4mm) on any tires, or 50% tread on high performance tires (911 Turbo, GT2, GT2 RS, GT3), the tire(s) must be replaced with the specified N-Rated tires.

- pass fail Brake pad wear (if less than 50% remains, replace pads)
approximate % of pad remaining
l/r 80 % r/l 80 % l/r 80 % r/r 80 %

F. Engine Compartment - Pass or Fail (Check one)

- pass fail Engine CO/HC
- pass fail Alternator function
- pass fail Ignition system
- pass fail Alternator/on-board voltage
- pass fail A/C compressor
- pass fail Belts (alternator/air-conditioning/fan/power steering)
- pass fail Engine (no visible defects, fluid loss, leaks)
- pass fail Electrical connections and fuses
- pass fail Battery: 12.7V | 12.6V
- pass fail Additional battery:

G. Fluids

- pass fail Engine oil
- pass fail Front/rear axle differential oil
- pass fail Transmission oil
- pass fail Coolant (antifreeze protection down to: _____ °C)
- pass fail Power steering hydraulic oil
- pass fail Brake fluid/clutch fluid
- pass fail Windscreen/headlight washer fluid

H. Interior (function and condition)

- pass fail Door locking system (child-proof locks)
- pass fail Remote control
- pass fail Alarm system and immobiliser
- pass fail Ignition/ignition lock
- pass fail Steering wheel lock
- pass fail Horn
- pass fail Airbag system (child seat deactivation)
- pass fail Wipers front/rear
- pass fail Headlight and windscreen washer system
- pass fail Steering column adjustment
- pass fail Seat belts and seat belt height adjustment
- pass fail Seat adjustment/position memory/heating
- pass fail Seat and head restraint upholstery
- pass fail Sun visors
- pass fail Roof lining
- pass fail Floor mats and carpet
- pass fail Interior trim and luggage compartment
- pass fail Glove box
- pass fail Cupholders
- pass fail Ashtrays
- pass fail Cigarette lighter/sockets (12V)
- pass fail Instrument panel (check while stationary)
- pass fail On-board clock
- pass fail On-board computer
- pass fail PCM (radio, telephone, CD, DVD, navigation system)
- pass fail CD changer
- pass fail Interior lighting
- pass fail Heating/ventilation/air-conditioning/climate control
- pass fail Exterior mirror/rear-view mirror adjustment
- pass fail Power windows (anti-pinch protection)
- pass fail Bonnet/tailgate release
- pass fail Roof (Cabriolet, Targa, sliding sunroof)
- pass fail Cabriolet: wind deflector
- pass fail Equipment/Exclusive equipment:

I. Test Drive

- pass fail (Cold)start/idling characteristics
- pass fail Braking effect (service brake and handbrake)
- pass fail ABS
- pass fail Suspension system
- pass fail PASM/air suspension
- pass fail Electronic Stability System (PSM, etc.)
- pass fail Power steering/Servotronic
- pass fail Steering wheel centered
- pass fail Straight-ahead travel
- pass fail Road behavior/handling
- pass fail Vehicle performance
- pass fail Clutch play
- pass fail Gear change
- pass fail Auxiliary heating
- pass fail Heating/ventilation system, air-conditioning system
- pass fail Rear window and mirror heating
- pass fail ParkAssist/reversing camera
- pass fail PCM (radio, telephone, CD, DVD, navigation system)
- pass fail Cruise control (all functions)
- pass fail Differential locks, all-wheel drive
- pass fail Instrument panel (while vehicle in motion)
- pass fail No unusual noises/vibrations
- pass fail Warm-start/idling characteristics

Certification

The signatures of the mechanic, service manager and pre-owned manager are confirmation that this Porsche has been meticulously inspected and that detected defects have been rectified in accordance with the Porsche Approved Certified Pre-owned Program. This inspection is invalid without all required signatures.

Date: 07/23/13 Technician 

Date: _____ Pre-owned Manager 

Date: _____ Service Manager 

INVOICE

Invoice #: **37062**

PORSCHE OF MONTEREY #184

1781 DEL MONTE BLVD.
SEASIDE, CA 93955
PHONE: (831) 899-8888
FAX: (831) 583-6262



Customer #: **T1183**

Contact: N/A

Home: Bus: Email:

EPA # CAL000314156 BAR # ARD00247143

Service Advisor: **92520 JOHN FRITZ**

COLOR	YEAR	MAKE/MODEL	VIN	LICENSE	MILEAGE IN	MILEAGE OUT
SIL/Silver	10	PORSCHE BOXSTER	WPOCB2A89AU730183		15510	15514
DEL DATE	PROD. DATE	WARR. EXP.	PROMISED	PO NO.	PAYMENT	R.O. OPENED
06DEC09	01JAN2010	18:00	22JUL13		CASH	22JUL13
OPTIONS: STK:AU730183PC ENG:3:4						

porscheofmontereycares.com
[877] 896-9147



Does Your Porsche Need A Spa Day?

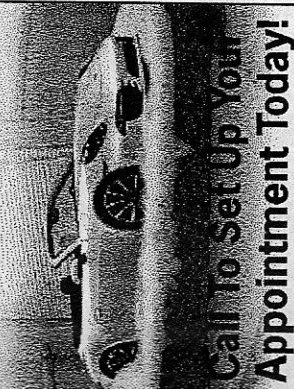

Call To Set Up Your Appointment Today!

ALL PARTS ARE NEW UNLESS OTHERWISE INDICATED.

If our Dealership does not have to return the parts to the manufacturer or distributor under a warranty arrangement and they are in excellent condition, we will return them to you upon request. If you choose to have replaced parts, please note that a core charge may apply.

Some Parts Not Returnable

ARBITRATION AGREEMENT
Any dispute between customer and the dealership arising from or related to this vehicle or this transaction will be settled by mandatory and binding arbitration pursuant to the Federal Arbitration Act 9 U.S.C. § 1 et. seq. The arbitration arbitrator, conducted by a single arbitrator. The arbitrator may be entitled to at law or in equity.

LINE	OPCODE	TECH	TYPE	HOURS	NET	TOTAL
A	PERFORM	PORSCHE	CERTIFIED	PRE-OWNED	VEHICLE	INSPECTION
	ENG	ENGINE	&	RELATED	REPAIRS	
	86383	IPM				
	LABOR:	0.00	OTHER:	0.00	TOTAL	LINE A:
	15514	COMPLETED. ALL CHECKED OUT OK				(N/C)
						0.00
B	CUSTOMER	REQUESTS	PERFORMED	ASSURED	USED	CAR
	UCD	CUSTOMER	REQUESTS	PERFORMED	ASSURED	USED
	DM	DETAIL	MATERIALS			
	89287	IPD				
	LABOR:	0.00	OTHER:	0.00	TOTAL	LINE B:
	15514	USED	CAR	DETAIL	COMPLETE	(N/C)
						0.00
C	CUSTOMER	REQUESTS	INSTALL	CLEAR	MATS	
	CM	CUSTOMER	REQUESTS	INSTALL	CLEAR	MATS
	89287	IPD				
	LABOR:	0.00	OTHER:	0.00	TOTAL	LINE C:
	15514	CLEAR	MATS	INSTALLED		(N/C)
						0.00

INTERNAL PAY HAZARDOUS WASTE FOR REPAIR ORDER
YOU MAY RECEIVE A SATISFACTION SURVEY BY PHONE OR MAIL. IF YOU'RE UNABLE TO ANSWER COMPLETELY SATISFIED TO ALL THE QUESTIONS, PLEASE CONTACT OUR SERVICE MANAGER. YOUR SATISFACTION IS OUR #1 GOAL! THANK YOU FOR COMING TO LITHIA PORSCHE OF SEASIDE!
BAR-AC247143 EPA # CAL000314156

DESCRIPTION		LABOR AMOUNT	PARTS AMOUNT	GAS, OIL, LUBE	SUBLET AMOUNT	WASTE DISPOSAL COSTS*	TOTAL CHARGES	LESS INS/DED/DIS	SALES TAX	THIS AMOUNT
*HAZARDOUS WASTE DISPOSAL COSTS: We have added this charge to cover costs associated with the handling, management and disposal of toxic wastes or hazardous substances under California and Federal law.										
By signing below, you acknowledge that you were notified of and authorized the Dealership to perform the services/repairs itemized in this invoice and that you received for had the opportunity to inspect any replaced parts as requested by you.										
AUTHORIZED DEALERSHIP REPRESENTATIVE SIGNATURE										0.00
CUSTOMER SIGNATURE										0.00
DATE										0.00

NOTICE TO CONSUMER: PLEASE READ IMPORTANT INFORMATION ON BACK. THANK YOU!

mileage: 13,290
Service advisor: 92520
Tag number: T380

13,295

Payment type: CASH
Promised time: 06:00 PM
Promised date: 12/05/2012

Waiter: No
Estimate: 0.00
Customer Comments: No

A PERFORM LUBE, OIL, AND FILTER SERVICE WITH COURTESY INSPECTION
LOF CPM PERFORM LUBE, OIL, AND FILTER SERVICE WITH COURTESY INSPECTION 1.00 130.50

Tech(s): 94899
9A1-107-224-00
996-107-313-51
900-123-106-30
0W40SYN

1 OIL-FILTER INSERT 27.12
1 O-RING 12.14
1 ALUM SEAL RING 2.81
9 0W40SYN OIL 76.50

Pts: 118.57 Lbr: 130.50 Other: 0.00 Total Line A: 249.07
Story: 13297 LUBE SERVICE COMPLETE.

B PERFORM COURTESY VEHICLE INSPECTION. INCLUDES: VISUAL INSPECTION OF VEHICLE, TIRE TREAD DEPTH, AND SET TIRE PRESSURE TO SPEC'S(LF RF LR RR).
VI IPM PERFORM COURTESY VEHICLE INSPECTION. INCLUDES: VISUAL INSPECTION OF VEHICLE, TIRE TREAD DEPTH, AND SET TIRE PRESSURE TO SPEC'S(LF RF LR RR). 0.00 0.00

Tech(s): 94899
Pts: 0.00 Lbr: 0.00 Other: 0.00 Total Line B: 0.00
Story: 13297 FRONT TIRE PRESSURES SET TO 30; REARS SET TO 31.
PLEASE SEE ATTACHED SHEET.

C CUSTOMER REQUESTS SET TO HAVE AUDIBLE SIGNAL WHEN LOCKING VEHICLE IF POSSIBLE OR REPORT.
EL IPM ELECTRICAL & RELATED REPAIRS 0.00 0.00

Tech(s): 94899
Pts: 0.00 Lbr: 0.00 Other: 0.00 Total Line C: 0.00
Story: 13297 AUDIBLE SIGNAL NOT AVAILABLE FOR THIS VEHICLE YEAR.

Customer Pay
Labor 130.50
Parts 118.57
Lube 0.00
Sublet 0.00
Miscellaneous/Shop Charge 0.00

A PERFORM LUBE, OIL, AND FILTER SERVICE WITH COURTESY INSPECTION
LOF CPR PERFORM LUBE, OIL, AND FILTER SERVICE WITH COURTESY INSPECTION 120.00

Tech(s): 86383
9A1-107-224-00
900-123-106-30
0W40SYN

1 OIL-FILTER INSERT 34.28
1 ALUM SEAL RING 2.66
9 0W40SYN OIL 76.50

Pts: 113.44 Lbr: 120.00 Other: 0.00 Total Line A: 233.44

Story: 9965 OIL SERVICE COMPLETE. FLUID LEVELS WERE TOPPED OFF.
TIRE PRESSURES WERE SET TO SPECIFICATIONS. THE SERVICE
REMINDER WAS THEN RESET.

B PERFORM BRAKE SYSTEM FLUSH
BSF CPR PERFORM BRAKE SYSTEM FLUSH 144.00

Tech(s): 86383
000-043-203-66

1 ORMD-BRAKE FLUID 1 L 34.83

Pts: 34.83 Lbr: 144.00 Other: 0.00 Total Line B: 178.83

Story: 9965 COMPLETE

C CUSTOMER REPORTS SPOILER WAS STUCK IN UP POSITION, BUT NOW APPEARS OK. CHECK FOR CODES, REPORT.
BM IPM BODY MISC REPAIRS N/C

Tech(s): 86383

Pts: 0.00 Lbr: 0.00 Other: 0.00 Total Line C: 0.00

Story: 9965 SPOILER FUNCTIONS PROPERLY. NO FAULTS CAN BE FOUND
IN CONTROL UNIT RESPONSIBLE FOR OPERATION.

D CUSTOMER REPORTS TRANSMISSION DOES NOT FEEL AS SMOOTH AS WHEN NEW. INSPECT AND REPORT.
TR IPM TRANSMISSION & RELATED REPAIRS N/C

Tech(s): 86383

Pts: 0.00 Lbr: 0.00 Other: 0.00 Total Line D: 0.00

Story: 9965 NO CODES STORED. ALL OK.

E PERFORM COURTESY VEHICLE INSPECTION. INCLUDES: VISUAL INSPECTION OF VEHICLE, TIRE TREAD DEPTH, AND SET TIRE PRESSURE TO SPEC'S(LF RF LR RR).
VI IPM PERFORM COURTESY VEHICLE INSPECTION. INCLUDES: VISUAL INSPECTION OF N/C

Service advisor: 92520
Tag number: T915

Payment type: CASH
Promised time: 06:00 PM
Promised date: 12/16/2011

Waiter: NO
Estimate: 0.00

VEHICLE, TIRE TREAD
DEPTH, AND SET TIRE
PRESSURE TO
SPEC'S(LF____ RF____
LR____ RR____).

Tech(s): 86383

Pts: 0.00 Lbr: 0.00 Other: 0.00 Total Line E: 0.00

Story: 9965 PLEASE SEE ATTACHED INSPECTION REPORT. FRONT TIRES
SET TO 32 PSI, REAR TIRES SET TO 34 PSI.

Customer Pay	
Labor	
Parts	264.00
Lube	148.27
Sublet	0.00
Miscellaneous/Shop Charge	0.00
Deductible	0.00
Total Charges	412.27
Less Insurance/Adjustment	0.00
Sales Tax	12.23
Total	424.50

Mileage: 5,234
Service advisor: 92520
Tag number: T421

Payment type: CASH, SD
Promised time: 06:00 PM
Promised date: 12/20/2010

Waiter: No
Estimate: 0.00

A PERFORM LUBE, OIL, AND FILTER SERVICE WITH COURTESY INSPECTION
LOF CPR PERFORM LUBE, OIL, AND FILTER SERVICE WITH COURTESY INSPECTION 120.00

Tech(s): 86383
9A1-107-224-00
900-123-106-30
0W40SYN
996-107-313-51

1 OIL-FILTER INSERT 31.08
1 ALUM SEAL RING 1.87
9 0W40SYN OIL 78.75
1 O-RING 11.91

Pts: 123.61 Lbr: 120.00 Other: 0.00 Total Line A: 243.61

Story: 5234 OIL SERVICE COMPLETE. FLUID LEVELS TOPPED OFF. TIRE PRESSURES SET TO SPECIFICATIONS. THE SERVICE REMINDER WAS RESET.

B PERFORM COURTESY VEHICLE INSPECTION. INCLUDES: VISUAL INSPECTION OF VEHICLE, TIRE TREAD DEPTH, AND SET TIRE PRESSURE TO SPEC'S(LF ___ RF ___ LR ___ RR ___).
VI IPM PERFORM COURTESY VEHICLE INSPECTION. INCLUDES: VISUAL INSPECTION OF VEHICLE, TIRE TREAD DEPTH, AND SET TIRE PRESSURE TO SPEC'S(LF ___ RF ___ LR ___ RR ___). N/C

Tech(s): 86383

Pts: 0.00 Lbr: 0.00 Other: 0.00 Total Line B: 0.00
Story: 5234 PLEASE SEE ATTACHED CHECKLIST.

Customer Pay
Labor 120.00
Parts 123.61
Lube 0.00
Sublet 0.00
Miscellaneous/Shop Charge 0.00
Deductible 0.00
Total Charges 243.61
Less Insurance/Adjustment 5.04
Sales Tax 11.43
Total 250.00

Repair Order Detail - Customer Copy

RO Number: 29934

RO Status:

Customer:

Phone(s): Contact:

Vehicle: WP0CB2A89AU730183

Main:

2010 BOX

Cell:

SIL/Silver

Mileage: 8

Service advisor: 92520

Tag number:

Payment type:

Promised time: 06:00 PM

Promised date: 12/04/2009

Waiter: No

Estimate:

~~~~~

|      |                      |      |                      |        |      |               |  |  |      |
|------|----------------------|------|----------------------|--------|------|---------------|--|--|------|
| A    | PERFORM NEW CAR PREP |      |                      |        |      |               |  |  |      |
|      | NCP                  | IPM  | PERFORM NEW CAR PREP |        |      |               |  |  | N/C  |
|      | Tech(s): 84164       |      |                      |        |      |               |  |  |      |
| Pts: | 0.00                 | Lbr: | 0.00                 | Other: | 0.00 | Total Line A: |  |  | 0.00 |

~~~~~

B	NEW CAR DETAIL - VEHICLE OFF TRANSPORT - NOT SOLD								
	NCDI	IPD	NEW CAR DETAIL -						N/C
			VEHICLE OFF TRANSPORT						
			- NOT SOLD						
	Tech(s): 89287								
	MISC	IPD							N/C
Pts:	0.00	Lbr:	0.00	Other:	0.00	Total Line B:			0.00

~~~~~

|                            |      |
|----------------------------|------|
| Customer Pay               |      |
| Labor                      | 0.00 |
| Parts                      | 0.00 |
| Lube                       | 0.00 |
| Sublet                     | 0.00 |
| Miscellaneous/Shop Charge* | 0.00 |
| Total Charges**            | 0.00 |

\*Miscellaneous/Shop Charge includes tax and/or deductible originally on RO.

\*\*Total Charges includes any Insurance/Adjustment originally on RO.